

# SUBMINIATURE PHOTOINTERRUPTER

## MIT-4A11A

### Description

The MIT-4A11A consists of a Gallium Arsenide infrared emitting diode and a NPN silicon phototransistor, double-layer mold plastic package. It is a transmissive subminiature photointerrupter.

### Package Dimensions

Unit : mm

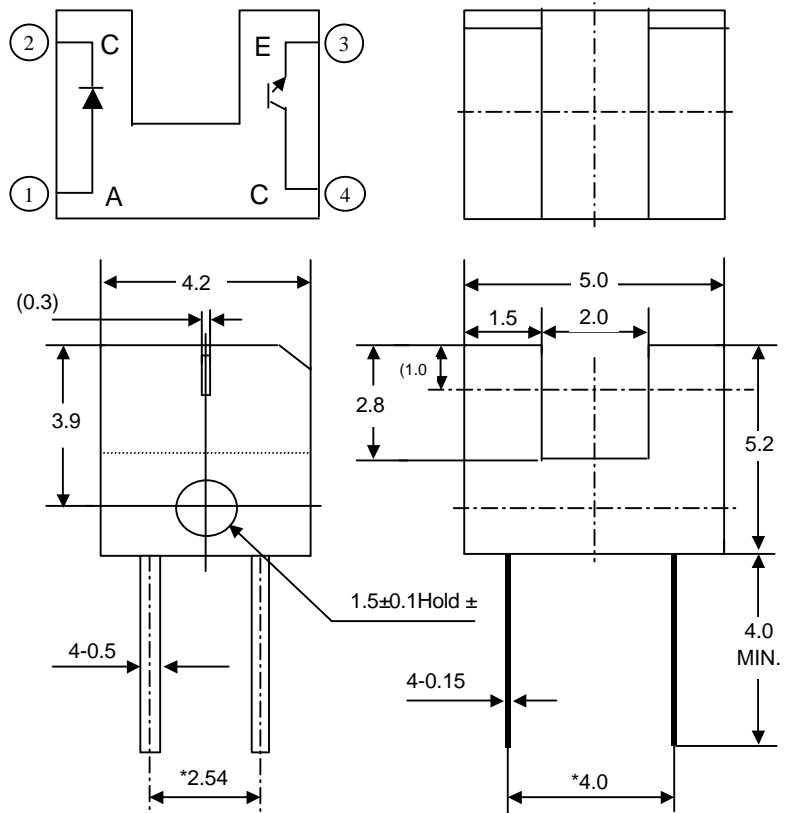

### Features

- Ultra-compact
- PWB mounting type package
- High sensing accuracy ( Slit width: 0.3mm )
- Gap between light emitter and detector: 2mm

### Applications

- Cameras
- Floppy disk drives
- Printer

### NOTE

1. Tolerance is  $\pm 0.25$  mm (.010") unless otherwise noted.
2. Burr's dimension : 0.15MAX
- 3.( ) : Reference dimensions
4. The dimensions indicated by \* refer to those measured from the lead base

### Absolute Maximum Ratings

@ $T_A = 25^\circ\text{C}$

Parameter		Symbol	Maximum Rating	Unit
INPUT	Continuous Forward Current	$I_F$	50	mA
	Reverse Voltage	$V_R$	5	V
	Power Dissipation	$P_{ad}$	75	mW
OUTPUT	Collector-emitter breakdown voltage	$V_{(BR)CEO}$	30	V
	Emitter-Collector breakdown voltage	$V_{(BR)ECO}$	5	V
	Collector power dissipation	$P_C$	75	mW
Total power dissipation		$P_{TOT}$	100	mW
Operating Temperature Range		$T_{opr}$	$-25^\circ\text{C}$ to $+85^\circ\text{C}$	
Storage Temperature Range		$T_{stg}$	$-40^\circ\text{C}$ to $+100^\circ\text{C}$	
Soldering temperature		$T_{sol}$	260°C for 3 seconds	

**UNI**

Unity Opto Technology Co., Ltd.

04/01/2002

## Optical-Electrical Characteristics

@T<sub>A</sub> = 25°C

Parameter		symbol	Min.	Typ.	Max.	Unit.	Test Conditions	
Input	Forward Voltage	V <sub>F</sub>	-	1.2	1.4	V	I <sub>F</sub> =20mA	
	Reverse Current	I <sub>R</sub>	-	-	10	μA	V <sub>R</sub> =3V	
Output	Collector Dark Current	I <sub>ceo</sub>	-	-	100	nA	V <sub>ce</sub> =10V	
	Collector Emitter Saturation Voltage	V <sub>CE(SAT)</sub>	-	-	0.4	V	I <sub>c</sub> =0.1mA, Ee=0.1mW/cm <sup>2</sup>	
Transfer Characteristics	Collector Current	I <sub>c</sub>	A	0.5	-	4.0	mA	I <sub>F</sub> =20mA, V <sub>ce</sub> =5V
			B	3.0	-	6.0		
			C	5.0	-	8.0		
			D	7.0	-	10.0		
	Response Time (RISE)	t <sub>r</sub>	-	50	150	μs	I <sub>c</sub> =100μA, V <sub>ce</sub> =5V	
Response Time (FALL)	t <sub>f</sub>	-	50	150	μs	R <sub>L</sub> =1KΩ		

## Typical Optical-Electrical Characteristic Curves

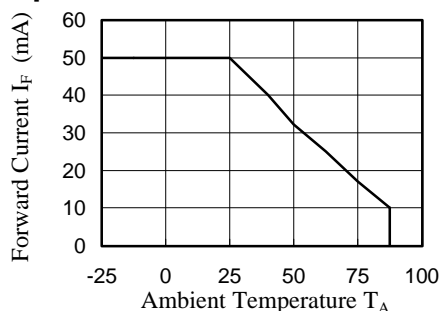

Fig.1 forward Current vs. Ambient Temperature

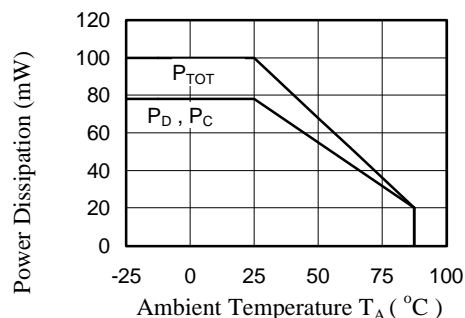

Fig.2 Power Dissipation vs. Ambient Temperature

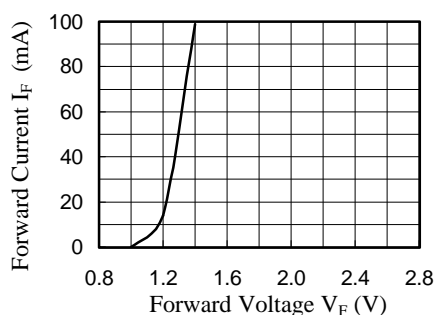

Fig.3 Forward Current vs. Forward Voltage

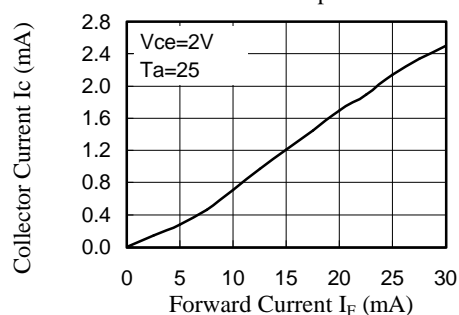

Fig.4 Collector Current vs. Forward Current

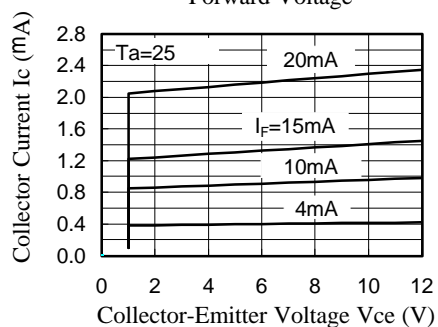

Fig.5 Collector Current vs. V<sub>ce</sub>

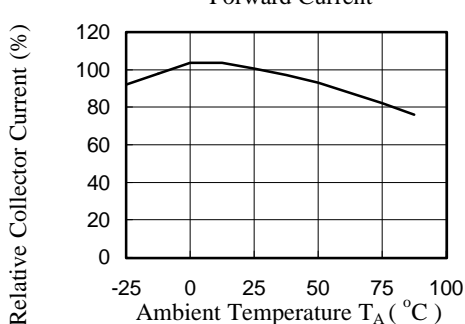

Fig.6 Relative Collector Current vs. T<sub>A</sub>

Typical Optical-Electrical Characteristic Curves

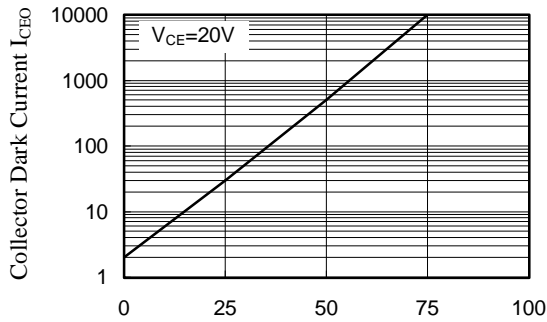

Fig.7 Collector Dark Current vs. Ambient Temperature

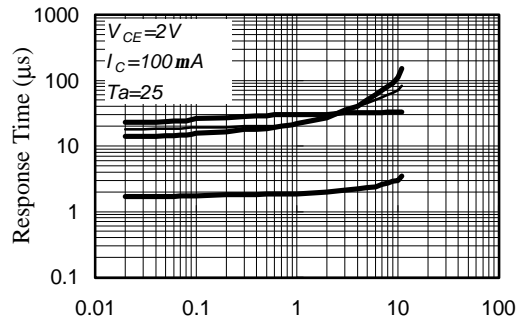

Fig.8 Response Time vs. Load Resistance

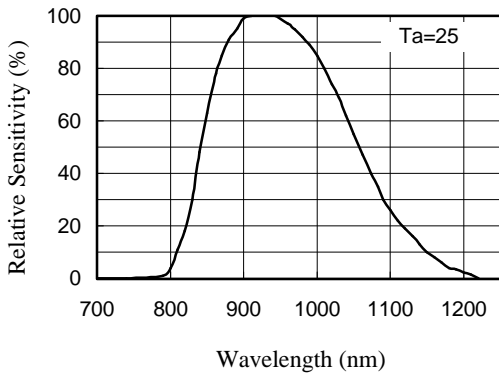
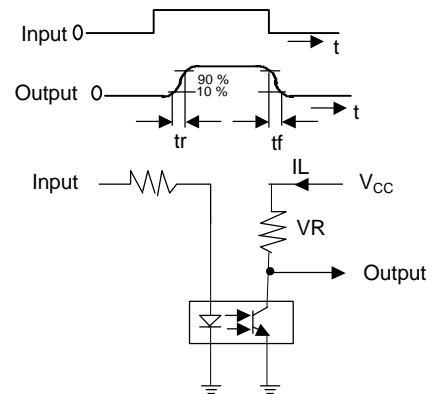

Fig.9 Spectral Sensitivity (Detecting side)

Response Time Measurement Circuit



Sensing Position Characteristics (Typical)

