

### FEATURES:

- 64K x 8-bit OTP EPROM organization
- RAD-PAK<sup>®</sup> radiation-hardened against natural space radiation
- Total dose hardness:
  - > 100 Krad (Si), depending upon space mission
- Excellent Single Event Effects:
  - SEL<sub>TH</sub> > 80 MeV/mg/cm<sup>2</sup>
  - SEU<sub>TH</sub> > 80 MeV/mg/cm<sup>2</sup>
- Package:
  - 32 pin RAD-PAK<sup>®</sup> flat pack
  - 32 pin RAD-PAK<sup>®</sup> DIP
- Fast access time:
  - 120, 150, 200 ns (max)
- Low power dissipation:
  - Active mode: 100 mW/MHz (typ)
  - Standby mode: 10 μW (typ)
- Programming power supply:
  - V<sub>pp</sub> = 12.5 V + 0.3 V
- One-time programmable
- Pin arrangement
  - JEDEC standard byte-wide EPROM
  - Flash memory and mask ROM compatible

### DESCRIPTION:

Maxwell Technologies' 27C512T high density 512-Kilobit one-time programmable electrically programmable read only memory microcircuit features a greater than 100 krad (Si) total dose tolerance, depending upon space mission. The 27C512T features fast address times and low power dissipation. The 27C512T offers high speed programming using page programming mode.

Maxwell Technologies' patented RAD-PAK<sup>®</sup> packaging technology incorporates radiation shielding in the microcircuit package. It eliminates the need for box shielding while providing the required radiation shielding for a lifetime in orbit or space mission. In a GEO orbit, RAD-PAK provides greater than 100 krad (Si) radiation dose tolerance. This product is available with screening up to Class S.

TABLE 1. 27C512T PINOUT DESCRIPTION

PIN	SYMBOL	DESCRIPTION
1	$V_{PP}$	Programming Voltage
2, 30	NC	Not connected
12-5, 27, 26, 23, 25, 4, 28, 29, 3	A0-A15	Address Enable
22	$\overline{CE}$	Chip Enable
24	$\overline{OE}$	Output Enable
13-15, 17-21	I/O0 - I/O7	Data Input/Output
16	GND	Ground
31	$\overline{PGM}$	Program
32	$V_{CC}$	+5V Power Supply

TABLE 2. 27C512T ABSOLUTE MAXIMUM RATINGS

PARAMETER	SYMBOL	MIN	MAX	UNIT
Supply Voltage <sup>1</sup>	$V_{CC}$	-0.6	+7.0	V
Programming Voltage <sup>1</sup>	$V_{PP}$	-0.6	+13.5	V
All Input and Output Voltage <sup>1,2</sup>	$V_{IN}, V_{OUT}$	-0.6	+7.0	V
A9 and OE Voltage	$V_{ID}$	-0.6	13.0	V
Operating Temperature Range	$T_{OPR}$	-55	+125	°C
Storage Temperature Range	$T_{STG}$	-65	+125	°C

1. Relative to  $V_{SS}$ .

2.  $V_{IN}$ ,  $V_{OUT}$ , and  $V_{ID}$  min = -1.0V for pulse width  $\leq$  20 ns.

TABLE 3. DELTA LIMITS

PARAMETER	VARIATION
$I_{SB}$	$\pm 10\%$
$I_{CC1}$	$\pm 10\%$
$I_{CC2}$	$\pm 10\%$
$I_{CC3}$	$\pm 10\%$

TABLE 4. 27C512T RECOMMENDED OPERATING CONDITIONS

PARAMETER	SYMBOL	MIN	MAX	UNITS
Supply Voltage	$V_{CC}$	4.5	5.5	V
Input Voltage	$V_{IL}$	-0.3 <sup>1</sup>	0.8	V
	$V_{IH}$	2.2	$V_{CC} + 1$ <sup>2</sup>	
Thermal Impedance — DIP Package	$\Theta_{JC}$	--	1.26	°C/W
Thermal Impedance — Flat Package	$\Theta_{JC}$	--	1.27	°C/W
Operating Temperature Range	$T_{OPR}$	-55	+125	°C

1.  $V_{IL}$  min = -1.0V for pulse width  $\leq$  50 ns.
2.  $V_{IH}$  max =  $V_{CC} + 1.5V$  for pulse width  $\leq$  20 ns.

TABLE 5. 27C512T CAPACITANCE <sup>1</sup>

PARAMETER	SYMBOL	MIN	MAX	UNIT
Input Capacitance	$C_{IN}$	--	10	pF
Output Capacitance	$C_{OUT}$	--	15	pF

1. Guaranteed by design.

TABLE 6. 27C512T DC ELECTRICAL CHARACTERISTICS FOR READ OPERATION

( $V_{CC} = 5V \pm 10\%$ ,  $V_{PP} = V_{SS}$  TO  $V_{CC}$ ,  $T_A = -55$  TO  $+125$  °C, UNLESS OTHERWISE SPECIFIED)

PARAMETER	TEST CONDITION	SYMBOL	SUBGROUPS	MIN	TYP	MAX	UNIT
Input Leakage Current	$V_{IN} = 5.5 V$	$I_{LI}$	1, 2, 3	--	--	2	$\mu A$
Output Leakage Current	$V_{OUT} = 5.5 V/0.45 V$	$I_{LO}$	1, 2, 3	--	--	2	$\mu A$
Standby $V_{CC}$ Current	$\overline{CE} = V_{IH}$	$I_{SB}$	1, 2, 3	--	--	1	mA
Operating $V_{CC}$ Current	$I_{OUT} = 0 mA$ , $\overline{CE} = V_{IL}$	$I_{CC1}$	1, 2, 3	--	--	30	mA
	$I_{OUT} = 0 mA$ , $f = 5 MHz$	$I_{CC2}$	1, 2, 3	--	--	30	
	$I_{OUT} = 0 mA$ , $f = 10 MHz$	$I_{CC3}$	1, 2, 3	--	--	50	
$V_{PP}$ Current	$V_{PP} = 5.5 V$	$I_{PP1}$	1, 2, 3	--	1	20	$\mu A$
Input Voltage		$V_{IH}$	1, 2, 3	2.2	--	--	V
		$V_{IL}$	1, 2, 3	--	--	0.8	
Output Voltage	$I_{OH} = -400 \mu A$	$V_{OH}$	1, 2, 3	2.4	--	--	V
	$I_{OL} = 2.1 mA$	$V_{OL}$	1, 2, 3	--	--	0.45	

TABLE 7. 27C512T AC ELECTRICAL CHARACTERISTICS FOR READ OPERATION <sup>1,2</sup>(V<sub>CC</sub> = 5V ± 10%, V<sub>PP</sub> = V<sub>SS</sub> TO V<sub>CC</sub>, T<sub>A</sub> = -55 TO +125 °C, UNLESS OTHERWISE SPECIFIED)

PARAMETER	TEST CONDITION	SYMBOL	SUBGROUPS	MIN	MAX	UNIT
Address Access Time -120 -150 -200	$\overline{CE} = \overline{OE} = V_{IL}$	t <sub>ACC</sub>	9, 10, 11	--	120 150 200	ns
Chip Enable Access Time -120 -150 -200	$\overline{OE} = V_{IL}$	t <sub>CE</sub>	9, 10, 11	--	120 150 200	ns
Output Enable Access Time -120 -150 -200	$\overline{CE} = V_{IL}$	t <sub>OE</sub>	9, 10, 11	--	60 70 70	ns
Output Hold to Address Change -120 -150 -200	$\overline{CE} = V_{IL}$	t <sub>OH</sub>	9, 10, 11	0 0 0	-- -- --	ns
Output Disable to High-Z <sup>3</sup> -120 -150 -200	$\overline{CE} = \overline{OE} = V_{IL}$	t <sub>DF</sub>	9, 10, 11	0 0 0	50 50 50	ns

- t<sub>DF</sub> is defined as the time at which the output becomes an open circuit and data is no longer driven.
- AC electrical parameters for programming operations are not tested. These are guaranteed by design.
- Test conditions:
  - Input pulse levels 0.45V/2.4V
  - Input rise and fall times < 10 ns
  - Output load 1TTL Fate + 100 pF (including scope and jig)
  - Referenced levels for measuring timing 0.8V/2.0V

TABLE 8. 27C512T AC ELECTRICAL CHARACTERISTICS FOR PROGRAMMING OPERATION<sup>1,2</sup> $(V_{CC} = 6.0V \pm 0.25V, V_{PP} = 12.5V + 0.3V, T_A = 25^\circ C)$ 

PARAMETER	SYMBOL	SUBGROUPS	MIN	TYP	MAX	UNIT
Address Setup Time	$t_{AS}$	9, 10, 11	2	--	--	$\mu s$
Address Hold Time	$t_{AH}$	9, 10, 11	0	--	--	$\mu s$
Data Setup Time	$t_{DS}$	9, 10, 11	2	--	--	$\mu s$
Data Hold Time	$t_{DH}$	9, 10, 11	2	--	--	$\mu s$
$V_{PP}$ Setup Time	$t_{VPS}$	9, 10, 11	2	--	--	$\mu s$
$V_{CC}$ Setup Time	$t_{VCS}$	9, 10, 11	2	--	--	$\mu s$
Output Enable Setup Time	$t_{OES}$	9, 10, 11	2	--	--	$\mu s$
Output Disable Time	$t_{DF}^3$	9, 10, 11	0	--	130	ns
$\overline{CE}$ Initial Programming Pulse Width	$t_{PW}$	9, 10, 11	0.19	0.20	0.21	ms
$\overline{CE}$ Overprogramming Pulse Width	$t_{OPW}$	9, 10, 11	0.19	--	5.25	ms
Output Enable Hold Time	$t_{OEH}$	9, 10, 11	2	--	--	$\mu s$
$V_{PP}$ Recovery Time	$t_{VR}$	9, 10, 11	2	--	--	$\mu s$
Data Valid from Chip Enable	$t_{DV}$	9, 10, 11	1	--	--	$\mu s$

- $t_{DF}$  is defined as the time at which the output becomes an open circuit and data is no longer driven.
- AC electrical parameters for programming operations are not tested. These are guaranteed by design.
- Test Conditions:
  - Input pulse levels  $0.45V/2.4V$
  - Input rise and fall times  $< 20\text{ ns}$
  - Referenced levels for measuring timing  $0.8V/2.0V$

TABLE 9. 27C512T DC ELECTRICAL CHARACTERISTICS FOR PROGRAMMING OPERATIONS<sup>1,2,3,4</sup> $(V_{CC} = 6.0V \pm 0.25V, V_{PP} = 12.5V + 0.3V, T_A = 25^\circ C)$ 

PARAMETER	TEST CONDITION	SYMBOL	SUBGROUPS	MIN	MAX	UNIT
Input Leakage Current	$V_{IN}=0V$ to $V_{CC}$	$I_{LI}$	1, 2, 3	--	2	$\mu A$
Operating $V_{CC}$ Current		$I_{CC}$	1, 2, 3	--	30	mA
Operating $V_{PP}$ Current	$\overline{CE}=\overline{PGM}=V_{IL}$	$I_{PP}$	1, 2, 3	--	40	mA
Input Voltage <sup>5</sup>		$V_{IH}$	1, 2, 3	2.2	$V_{CC}+0.5^6$	V
		$V_{IL}$	1, 2, 3	-0.1 <sup>7</sup>	0.8	
Output Voltage	$I_{OH}=-400\mu A$	$V_{OH}$	1, 2, 3	2.4	--	V
	$I_{OH}= 2.1mA$	$V_{OL}$	1, 2, 3	--	0.45	

- $V_{CC}$  must be applied before  $V_{PP}$  and removed after  $V_{PP}$ .
- $V_{PP}$  must not exceed 13V, including overshoot.
- Do not change  $V_{PP}$  from  $V_{IL}$  to 12.5V or 12.5V to  $V_{IL}$  when  $\overline{CE} = \text{low}$ .
- DC electrical parameters for programming operations are not tested. These are guaranteed by design.
- Device reliability may be adversely affected if the device is installed or removed while  $V_{PP} = 12.5V$ .

6. If  $V_{IH}$  is over the specified maximum value, programming operation can not be guaranteed.  
 7.  $V_{IL}$  min = -0.6V for pulse width  $\leq 20$  ns.

TABLE 10. 27C512T MODE SELECTION

MODE	$V_{PP}$	$V_{CC}$	$\overline{CE}$	$\overline{OE}$	$\overline{PGM}$	$A_9$	I/O
Read	$V_{CC}$	$V_{CC}$	$V_{IL}$	$V_{IL}$	$V_{IH}$	X <sup>1</sup>	$D_{OUT}$
Output Disable	$V_{CC}$	$V_{CC}$	$V_{IL}$	$V_{IH}$	$V_{IH}$	X	High-Z
Standby	$V_{CC}$	$V_{CC}$	$V_{IH}$	X	X	X	High-Z
Program	$V_{PP}$	$V_{CC}$	$V_{IL}$	$V_{IH}$	$V_{IL}$	X	$D_{IN}$
Program Verify	$V_{PP}$	$V_{CC}$	$V_{IL}$	$V_{IL}$	$V_{IH}$	X	$D_{OUT}$
Page Data Latch	$V_{PP}$	$V_{CC}$	$V_{IH}$	$V_{IL}$	$V_{IH}$	X	$D_{IN}$
Page Program	$V_{PP}$	$V_{CC}$	$V_{IH}$	$V_{IH}$	$V_{IL}$	X	High-Z
Program Inhibit	$V_{CC}$	$V_{CC}$	$V_{IL}$	$V_{IL}$	$V_{IL}$	X	High-Z
	$V_{PP}$	$V_{CC}$	$V_{IL}$	$V_{IH}$	$V_{IH}$	X	High-Z
	$V_{PP}$	$V_{CC}$	$V_{IH}$	$V_{IL}$	$V_{IL}$	X	High-Z
	$V_{PP}$	$V_{CC}$	$V_{IH}$	$V_{IH}$	$V_{IH}$	X	High-Z
Identifier	$V_{CC}$	$V_{CC}$	$V_{IL}$	$V_{IL}$	$V_{IH}$	$V_H^2$	ID

1. X = Don't care.  
 2.  $11.5V < V_H < 12.5V$ .

FIGURE 1. READ TIMING WAVEFORM

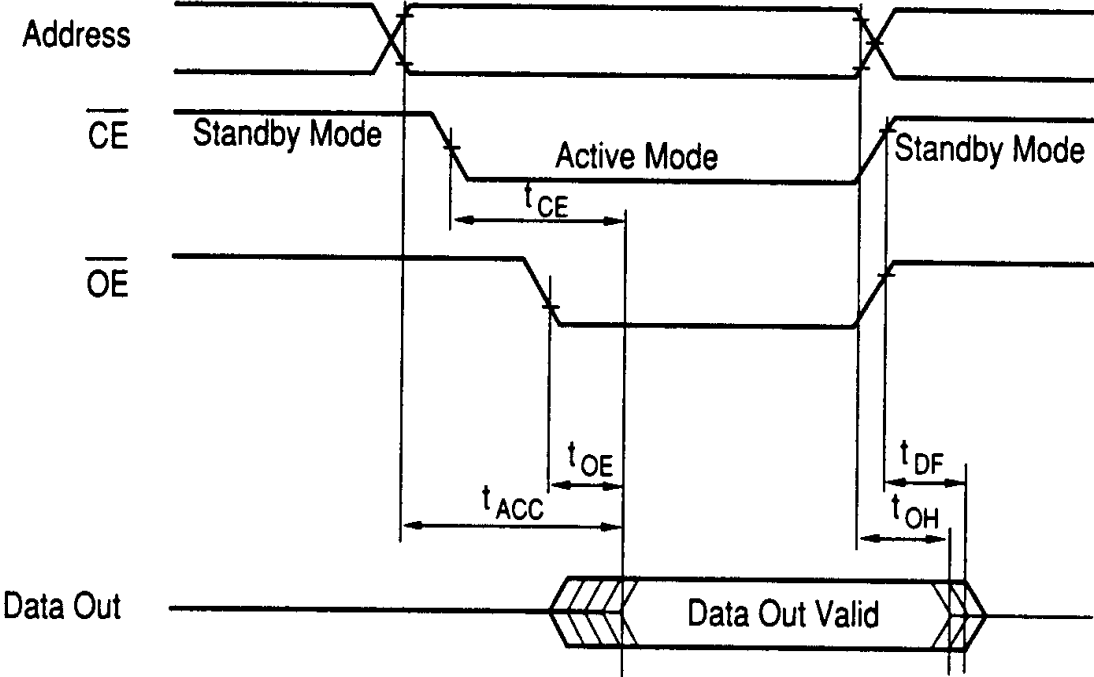

FIGURE 2. PAGE PROGRAMMING FLOWCHART

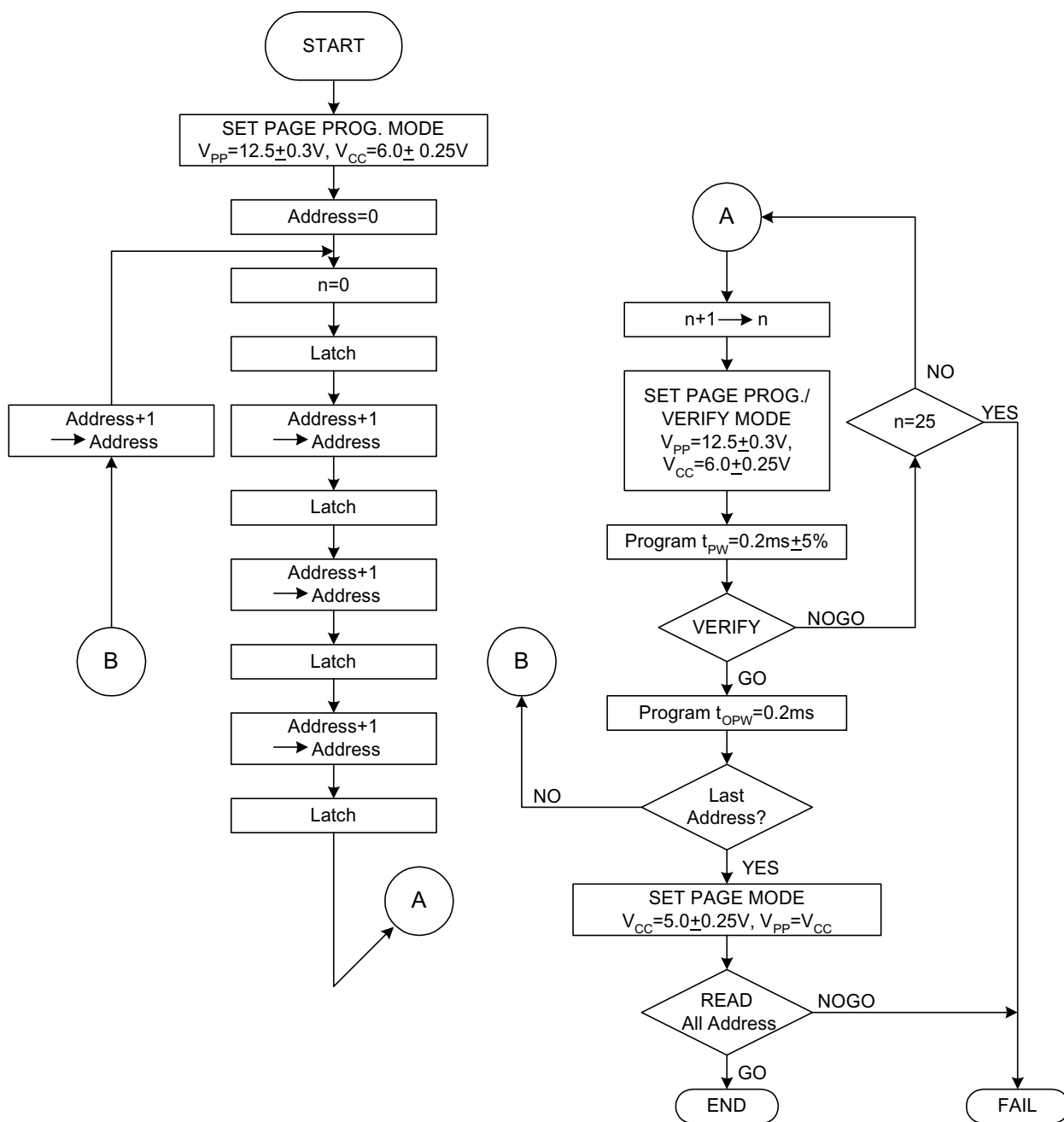



FIGURE 3. PAGE PROGRAMMING TIMING WAVEFORM

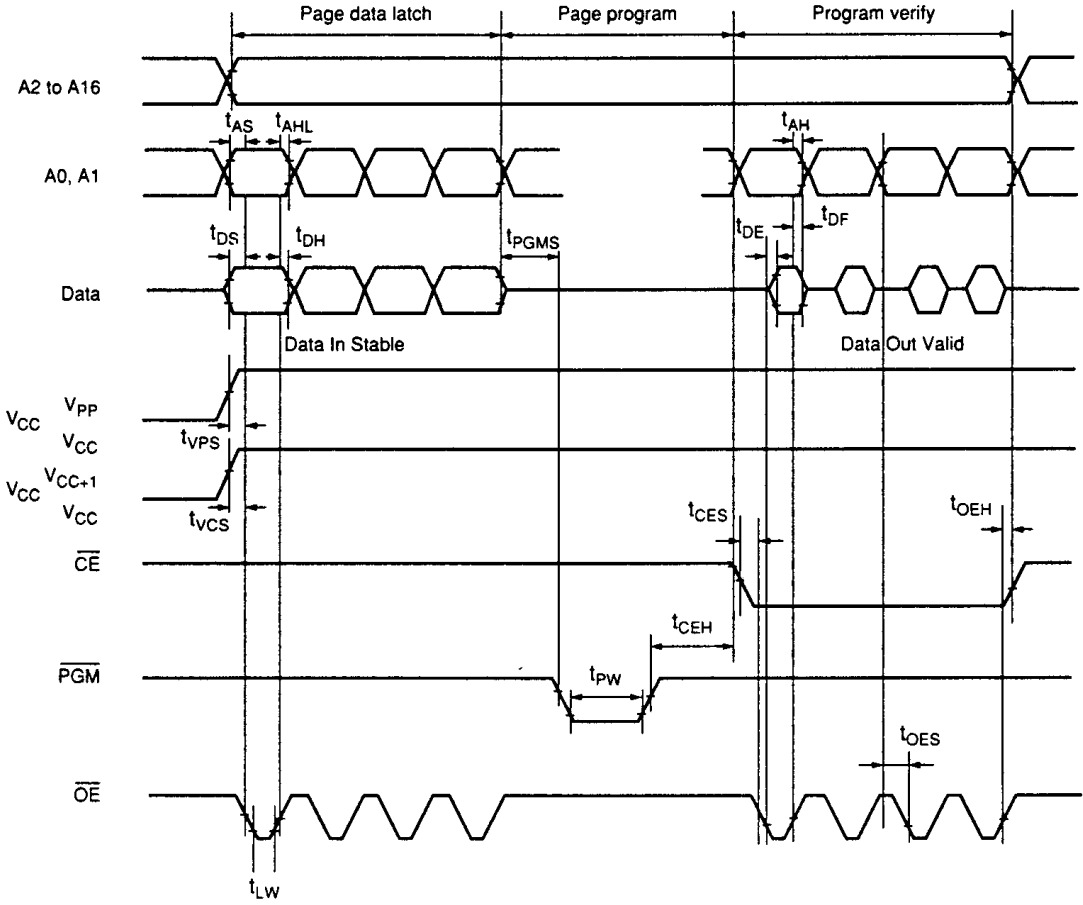

FIGURE 4. BYTE PROGRAMMING FLOWCHART

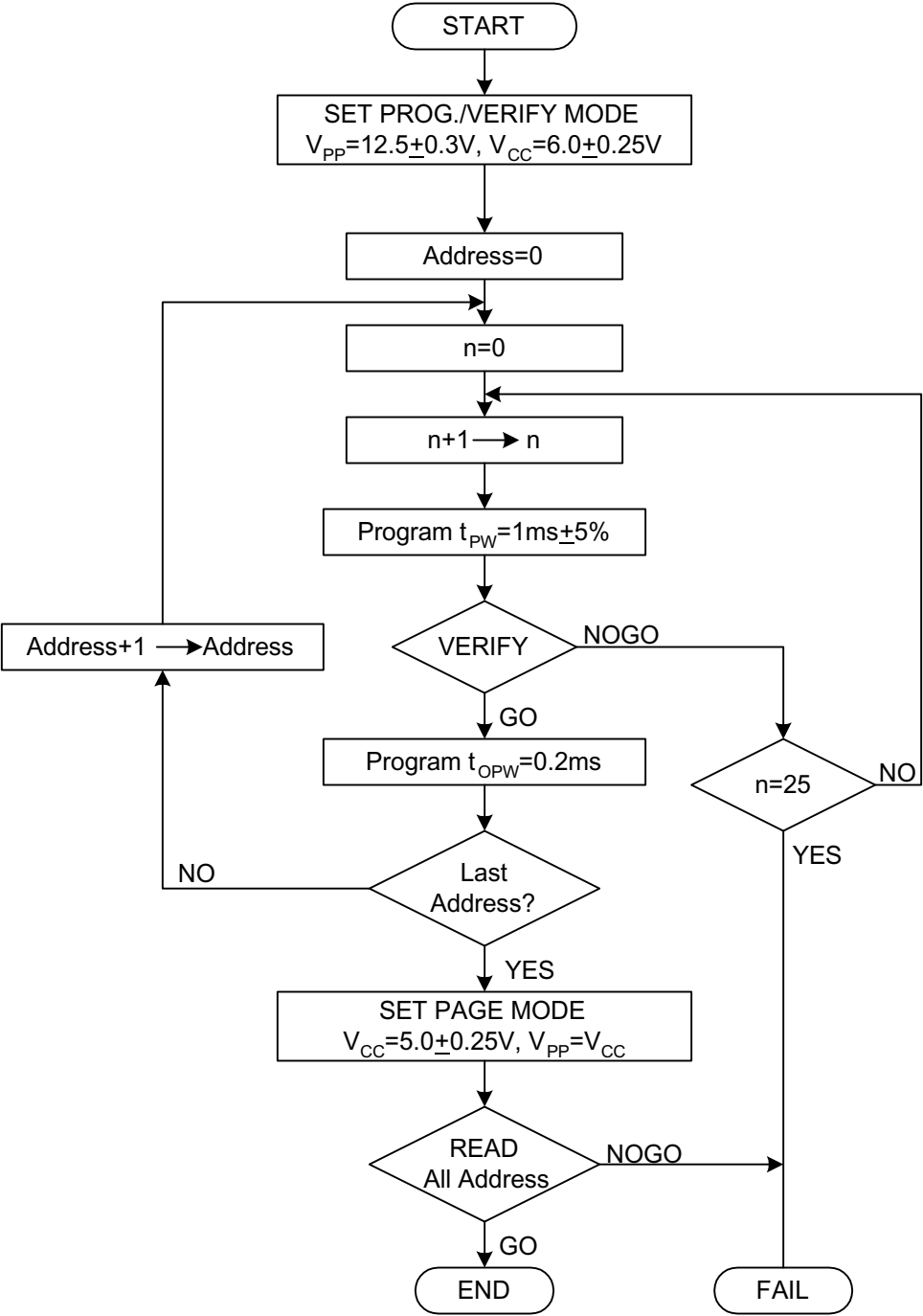
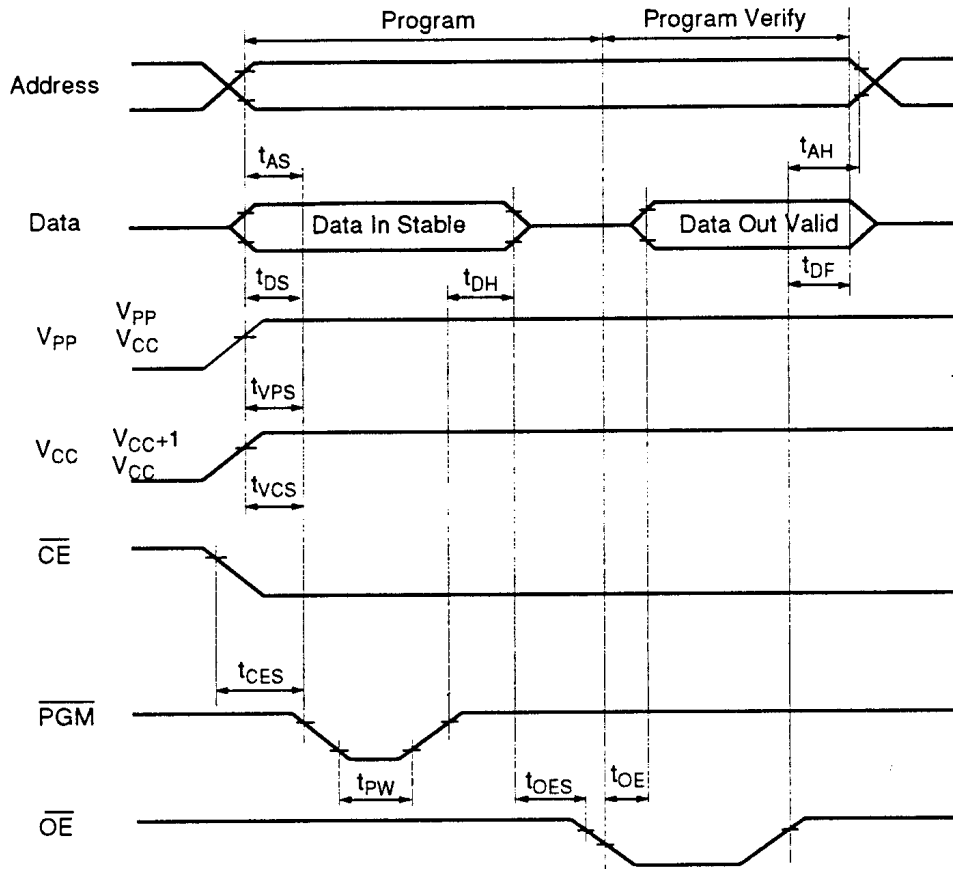

FIGURE 5. BYTE PROGRAMMING TIMING WAVEFORM



DEVICE IDENTIFIER MODE DESCRIPTION

The Device Identifier Mode allows binary codes to be read from the outputs that identify the manufacturer and the type of device. Using this mode with programming equipment, the device will automatically match its own erase and programming algorithm.

27C512T SERIES IDENTIFIER CODE

IDENTIFIER	A <sub>0</sub>	I/O <sub>7</sub>	I/O <sub>6</sub>	I/O <sub>5</sub>	I/O <sub>4</sub>	I/O <sub>3</sub>	I/O <sub>2</sub>	I/O <sub>1</sub>	I/O <sub>0</sub>	HEX DATA
MANUFACTURER CODE	V <sub>IL</sub>	0	0	0	0	0	1	1	1	07
DEVICE CODE	V <sub>IH</sub>	0	0	1	1	1	0	0	0	38

1. V<sub>CC</sub> = 5.0V ± 10%.
2. A<sub>0</sub> = 12.0V ± 0.5V.
3. A<sub>1</sub>-A<sub>8</sub>, A<sub>10</sub>-A<sub>16</sub>,  $\overline{CE}$ ,  $\overline{OE}$  = V<sub>IL</sub>,  $\overline{PGM}$  = V<sub>IH</sub>.
4. X = Don't care.

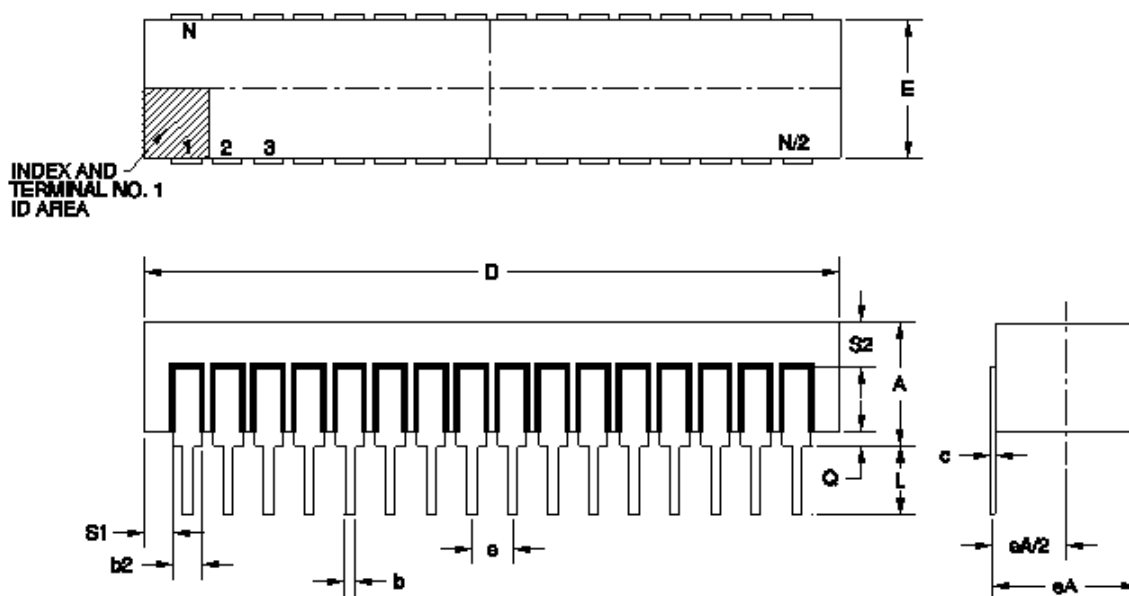

32 PIN RAD-PAK® DUAL IN LINE PACKAGE<sup>1</sup>

SYMBOL	DIMENSION		
	MIN	NOM	MAX
A	--	0.215	0.240
b	0.014	0.018	0.026
b2	0.045	0.050	0.065
c	0.008	0.010	0.018
D	--	1.600	1.680
E	0.510	0.590	0.620
eA	0.600 BSC		
eA/2	0.300 BSC		
e	0.100 BSC		
L	0.125	0.145	0.155
Q	0.015	0.035	0.070
S1	0.005	0.025	--
S2	0.005	--	--
N	32		

1. Standard Product Screening Flow MIL-STD-883, Method 2001, Constant Acceleration: For this package type Constant Acceleration is 3000g's.

Note: All dimensions in inches

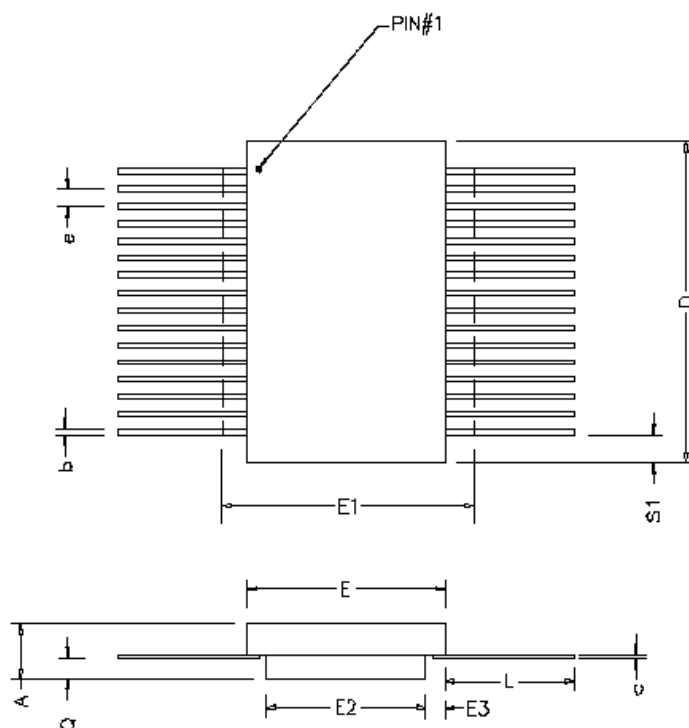

32 PIN RAD-PAK® FLAT PACKAGE

SYMBOL	DIMENSION		
	MIN	NOM	MAX
A	0.198	0.210	0.220
b	0.015	0.017	0.020
c	0.004	0.005	0.009
D	--	0.820	0.830
E	0.472	0.480	0.488
E1	--	--	0.498
E2	0.300	0.310	--
E3	0.030	0.085	--
e	0.050 BSC		
L	0.355	0.365	0.375
Q	0.055	0.065	0.075
S1	0.005	0.027	--
N	32		

Note: All dimensions in inches

## Important Notice:

These data sheets are created using the chip manufacturers published specifications. Maxwell Technologies verifies functionality by testing key parameters either by 100% testing, sample testing or characterization.

The specifications presented within these data sheets represent the latest and most accurate information available to date. However, these specifications are subject to change without notice and Maxwell Technologies assumes no responsibility for the use of this information.

Maxwell Technologies' products are not authorized for use as critical components in life support devices or systems without express written approval from Maxwell Technologies.

Any claim against Maxwell Technologies must be made within 90 days from the date of shipment from Maxwell Technologies. Maxwell Technologies' liability shall be limited to replacement of defective parts.

## Product Ordering Options

