



Stratix II EP2S60 DSP Development Board

DS-S29804

Data Sheet

Features

The Stratix® II EP2S60 DSP development board is included with the DSP Development Kit, Stratix II Edition (ordering code DSP-DEVKIT-2S60). This board is a development platform for high-performance digital signal processing (DSP) designs, and features the Stratix II EP2S60 device in a 1020-pin package.

Components

- Analog I/O
 - Two 12-bit 125-MHz A/D converters
 - Two 14-bit 165-MHz D/A converters
 - One 8-bit, 180 megapixels-per-second triple D/A converter for VGA output
 - One 96-KHz Stereo Audio coder/decoder (CODEC)
- Memory subsystem
 - 1 MByte of 10-ns asynchronous SRAM configured as a 32-bit bus
 - 16 MBytes of flash memory configured as an 8-bit bus
 - 32 MBytes of SDRAM memory configured as a 64-bit bus
 - CompactFlash connector supporting ATA and IDE access modes
- Configuration options
 - On-board configuration using 16 MBytes of flash memory and an Altera® EPM7256 MAX® device
 - Download configuration data using a USB Blaster™ download cable
- Single-ended or differential inputs and outputs accessed via a Mictor connector
- Dual seven-segment display
- Four user-defined push-button switches
- One female 9-pin RS-232 connector
- 10/100 Ethernet MAC/PHY
- Eight user-defined LEDs
- Socketed 100-MHz oscillator
- Single 16-V DC power supply (adapter included)
- Active heat sink

Debugging Interfaces

- One Mictor-type connector for Agilent and Tektronix logic analyzers
- Several 0.1-inch headers

Expansion Interfaces

- Two connectors for Analog Devices A/D converter daughter cards
- Connector for Texas Instruments Evaluation Module (TI-EVM) daughter cards
- Two Expansion Prototype connectors

General Description

The Stratix II EP2S60 DSP development board provides a hardware platform that designers can use to start developing DSP systems based on Stratix II devices. Combined with DSP intellectual property (IP) from Altera and Altera Megafunction Partners Program (AMPPSM) partners, users can quickly develop powerful DSP systems. Altera's unique OpenCore[®] Plus technology allows users to evaluate MegaCore[®] functions in hardware prior to licensing them.

DSP Builder (version 2.2.0 or higher) includes a library for the Stratix II EP2S60 DSP development board. This library allows algorithm development, simulation, and verification on the board, all from within the MathWorks MATLAB/Simulink system-level design tool. Additionally, the Stratix II DSP development board includes a Texas Instruments' EVM (cross-platform) daughter card connector, which enables development and verification of FPGA co-processors for offloading and accelerating compute-bound algorithms from programmable DSP processors.

Components & Interfaces

Figure 1 shows a top view of the board components and interfaces.

Figure 1. Stratix II EP2S60 DSP Development Board Components & Interfaces

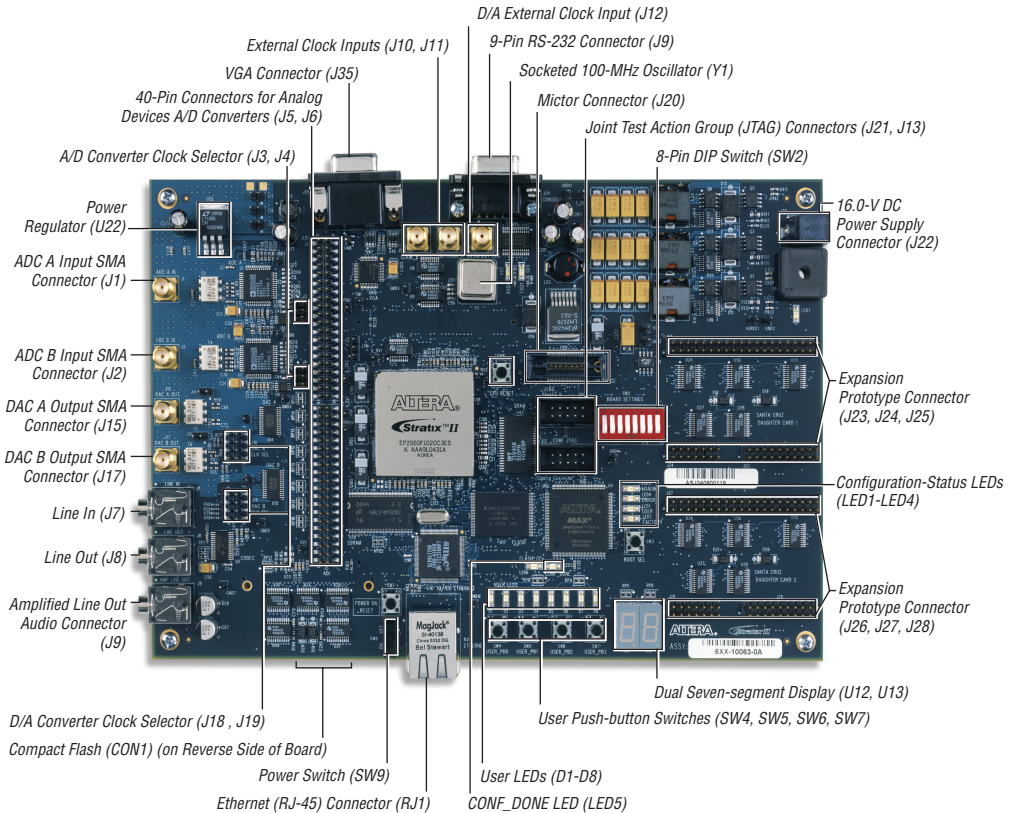

Note to Figure 1:

- (1) A TI-EVM/FPDP connector (J31, J33) is found on the reverse side of the board.

Table 1 describes the components on the board and the interfaces it supports.

Table 1. Stratix II EP2S60 DSP Development Board Components & Interfaces (Part 1 of 2)			
Component/ Interface	Type	Board Designation	Description
Components			
Stratix II device	FPGA	U18	EP2S60 Stratix II device
MAX Device	PLD	U10	EPM7256ETC144 device
A/D converters	I/O	U1, U2	Two 12-bit 125-MHz A/D converters
D/A converters	I/O	U14, U15	Two 14-bit 165-MHz D/A converters
1 MByte SRAM	Memory	U43, U44	1 MByte of 10-ns asynchronous SRAM configured as a 32-bit bus.
16 MBytes of flash memory	Memory	U17	16 Mbytes of flash memory configured as an 8-bit bus.
32 MBytes of SDRAM	Memory	U39, U40	32 MBytes of SDRAM memory configured as a 64-bit bus
SMA external clock input connectors	Input	J10, J11, J12	SMA connectors for inputs of external clock signals, terminated in 50 Ω
Dual seven-segment display	Display	U12, U13	Dual seven-segment display.
Push-button switches	I/O	SW4, SW5, SW6, SW7	Four push-button switches, which are user-defined as logic inputs.
User-defined LEDs	Display	D1 - D8	Eight user-defined LEDs.
Power-on LED	Display	LED7	LED that illuminates when power is supplied to the board.
CONF_DONE LED	Display	LED5	LED that illuminates upon successful configuration of the Stratix II device.
RS-232 connector	I/O	J29	DB9 connector, configured as a DTE serial port. The interface voltages are converted to 3.3-V signals and brought to the Stratix II device, which must be configured to generate and accept transmissions.
100-MHz oscillator	Clock	Y1	Socketed on-board 100-MHz oscillator.
Single 16-V DC power supply	Input	J22 (adapter)	Board adapter for included 16-V DC power supply
Stratix II device Joint Test Action Group (JTAG) Connector	I/O	J21	JTAG Connector used to configure the Stratix II device directly
Configuration controller JTAG Connector	I/O	J13	JTAG connector used to configure the configuration controller

Table 1. Stratix II EP2S60 DSP Development Board Components & Interfaces (Part 2 of 2)

Component/ Interface	Type	Board Designation	Description
VGA D/A Converter	I/O	U45	One 8-bit, 180 megapixels-per-second triple D/A converter for VGA output
Audio CODEC	I/O	U5	96-KHz stereo audio CODEC
CompactFlash card connector	I/O	CON1	CompactFlash card connector
Debugging Interfaces			
Mictor connectors	I/O	J20	One Mictor header connected to 33 pins on the Stratix II device (32 data signals, 1 clock signal) for use with an external logic analyzer.
Expansion Interfaces			
Analog Devices connector (1)	Expansion	J5, J6	Interface to Analog Device's A/D converters via two 40-pin connectors.
TI-EVM connectors	Expansion	J31, J33	Interface to the TI-EVM. (The connectors are on the reverse side of the board.)
Expansion Prototype Connectors	Expansion	J23 - J25, J26 - J28	The board provides two custom interfaces to daughter cards via 74-pin headers. (These pins can also be used for general I/O.) These connectors are referred to on the board as "Santa Cruz Daughter Card 1" and "Santa Cruz Daughter Card 2"

Note to Table 1:

- (1) These headers can be used to interface to Analog Devices A/D converter evaluation boards. They are designated as J5 and J6, and interface to Analog Devices AD6645/9433/9430 external A/D converters.

Environmental Requirements

The Stratix II EP2S60 DSP development board must be stored between -40°C and 100°C . The recommended operating temperature is between 0°C and 55°C .



The Stratix II EP2S60 DSP development board can be damaged without proper anti-static handling.



The DSP Development Kit, Stratix II Edition includes a heat sink and fan combination, also known as an active heat sink. Depending on the specific requirements of your application, this level of cooling may not be necessary. Refer to ["Install the Active Heat Sink"](#) on page 49 for more information.

Using the Board

When power is applied to the board and SW9 is in the "ON" position, the Power-on LED (LED7) illuminates. At that time, the MAX device (U10) programs the Stratix II device (U18) from one of 4 flash memory spaces reserved for configuration information. If configuration is successful, the CONF_DONE LED (LED5) illuminates.



If the Stratix II device is programmed with a design in one of the user configuration memory spaces or using the JTAG connector (J21), both the CONF_DONE LED (LED5) and the USER LED (LED1) illuminate. For more information, refer to ["Configuration-Status LEDs" on page 18.](#)

To configure the board with a new design, the designer should perform the following steps, explained in detail in this section.

1. Apply power to the board.
2. Re-configure the Stratix II device.

Apply Power

Apply power to the board by connecting the 16-V DC power supply adapter, provided in the DSP Development Kit, Stratix II edition, to the on-board power adapter connector (J22), and switching SW9 to the ON position. All of the board components draw power either directly from this 16-V supply or from the 3.3-V, 1.2-V, and 5-V regulators that are powered by the 16-V supply.



The 3.3-V supply provides V_{CCIO} to the Stratix II device and all LVTTTL board components. The 1.2-V supply provides V_{CCINT} to the Stratix II device.

When power is applied to the board, the Power On LED (LED7) illuminates.



The Stratix II EP2S60 device, the A/D and D/A converters, and power regulator U22 become hot as the board is used. Because their surface temperature may significantly increase, **do not touch these devices while power is applied to the board.**

Configure the Stratix II Device Directly

You can configure the Stratix II device directly, without turning off power, using the Quartus® II software and the USB Blaster cable, as follows.

1. Attach the cable to J21, also labeled “JTAG Stratix II”.
2. Open a Quartus II SRAM Object File (.sof), which starts the Quartus II Programmer.
3. Select **USB Blaster** as the hardware.
4. Set the mode to **JTAG**.
5. Click **Start**.

After successful configuration, the CONF_DONE LED (LED5) illuminates.



Refer to Quartus II Help for instructions on how to use the USB Blaster cable.

Non-Volatile Configuration

The designer must reconfigure the Stratix II device each time power is applied to the Stratix II DSP development board. For designers who want to power up the board and have a design immediately present in the Stratix II device, the board has a non-volatile configuration scheme. This scheme consists of a configuration controller (U10), which is an Altera EPM7256 PLD, and flash memory. The configuration controller device is non-volatile (i.e., it does not lose its configuration data when the board is powered down) and it comes factory-programmed with logic that configures the Stratix II EP2S60F1020C4 device (U18) from data stored in flash (U17) on power-up. Upon power-up, the configuration controller begins reading data from the flash memory. The flash memory, Stratix II device, and configuration controller are connected so that data from the flash configures the Stratix II device in fast passive-parallel mode.

Configuration Data

The Quartus II software can produce Hexadecimal (Intel format) Output (**.hexout**) files suitable for download and storage in the flash memory as configuration data. The designer can create a HEXOUT file using the Quartus II software in one of the following ways:

- Create a HEXOUT file at the end of compilation
- Convert a SRAM Object File (**.sof**) to a HEXOUT file.

Write a HEXOUT file at Compilation

To set up a project so that the Quartus II software writes a HEXOUT file at the end of compilation, perform the following steps:

1. Choose **Settings** (Assignments menu).
2. Click **Device** under **Compiler Settings**.
3. Click **Device and Pin Options**.
4. Click the **Programming Files** tab.
5. Turn on the **Hexadecimal (Intel-Format) Output File (.hexout)** option. With this option turned on, the Quartus II software generates a **.hexout** at the end of a successful compilation.

Convert a SOF to a HEXOUT File

The designer can convert a SOF to a HEXOUT file by performing the following steps in the Quartus II software:

1. Choose **Convert Programming Files** (File menu).
2. Under **Output programming file**, choose **Hexadecimal (Intel-Format) Output File for SRAM (.hexout)** from the **Programming file type** list box.
3. Specify an output file name in the **File name** box. The default is **output_file.hexout**.
4. Click **SOF Data** under **Input files to convert**.
5. Click **Add File**.
6. Browse to the SOF to convert and click **OK**. The Quartus II software converts the file and saves the output file to the specified directory.



Intel-format HEXOUT files contain data that is not actually written to the flash memory. The **Write2Flash** executable file (provided in the *<installation directory>/utilities/Flash_Programmer* directory) parses the HEXOUT file and creates a file with the extension **.hexout.flash** that contains the data to be written to flash memory. The designer can then send this file serially to the board via an RS-232 cable and write it to flash memory by the factory configuration as described in the next section.

Factory & User Configurations

The configuration controller can manage four separate Stratix II device configurations as HEXOUT data stored in flash memory: three user designs and a factory design. On power-up, the configuration controller reads one of the four (user or factory) designs from the flash memory and programs the Stratix II device accordingly. The user can select which design the Stratix II device is programmed with by setting the DIP switches on SW2.

DIP switches 1 through 3 on SW2 select one of four possible Stratix II configuration images upon power-up. When DIP switch 4 is in the “OPEN” position the configuration controller is enabled. If DIP switch 4 is in the “OPEN” position and there are no valid user-defined images, the Stratix II device is programmed with the factory configuration. [Table 2](#) shows the DIP switch combinations used to select the available images. See [“Non-Volatile Configuration” on page 7](#) for more details.



An alternative method of configuring the device with the factory design is to press push-button switch SW3.

Table 2. Configuration DIP Switch (SW2) Combinations

Image	Switch 1	Switch 2	Switch 3	Switch 4
User0	Closed	Closed	Closed	Open
User1	Open	Closed	Closed	Open
User2	Closed	Open	Closed	Open
Factory	Open	Open	Open	Open



Switch 4 must be set to “OPEN” to enable the configuration controller.



To download a Quartus II-generated HEXOUT file to the flash memory on the board, refer to the *Nios II Flash Programmer User Guide* included on the *DSP Development Kit, Stratix II Edition version 1.0.0 CD-ROM*.

The Factory Design

When the Stratix II device is programmed with the factory design, LEDs D5 through D8 behave as a binary counter that counts down to zero. This is a power-up indication that the board is functional and the device was successfully programmed with the factory design.

Along with the LED counter, the factory design includes two blocks of IP generated by the Altera NCO Compiler. One of these oscillators is running at 10 times the frequency of the other, but both of them have the same amplitude, covering 13 bits of dynamic range. Two sine waves generated by these blocks are added together and the output is converted from a 2's complement representation into unsigned integer format. This combined sine wave signal of 14-bits dynamic range is sent to a 14-bit D/A converter.

When the analog output of the D/A converter is connected, via the included SMA cable, with the analog input of one of the 12-bit A/D converters, the A/D converter's digital output is looped back to the Stratix II device. The design converts this loopback input from 2's complement format to unsigned integer format. The converted loopback data is captured by an instance of the SignalTap® II logic analyzer in the design for display and analysis.



For step-by-step instructions on how to use the factory design to test the functionality of the board, refer to the *DSP Development Kit, Stratix II Edition Getting Started User Guide*.

Functional Description

This section describes the elements of the Stratix II EP2S60 DSP development board. [Figure 2](#) shows a block diagram of the board.

Figure 2. Stratix II EP2S60 Development Board Block Diagram

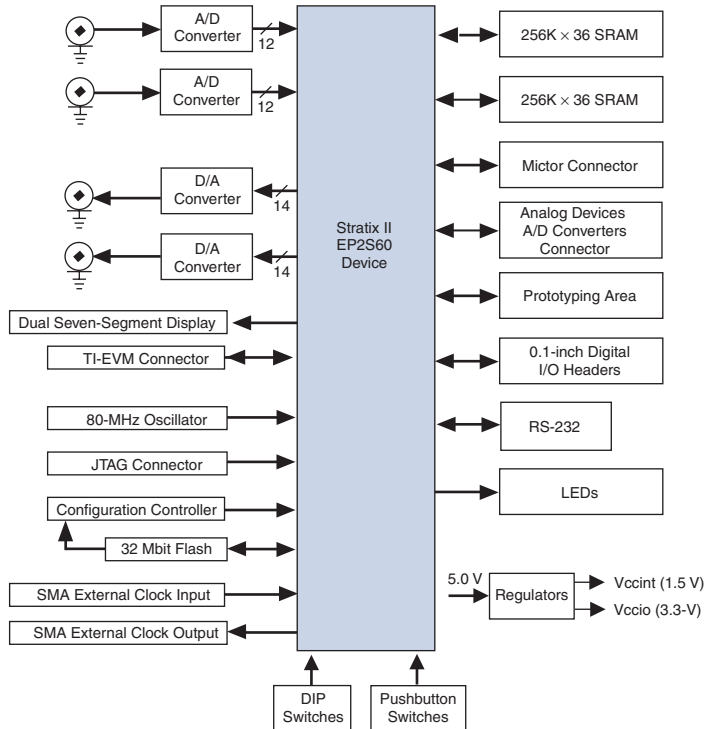

Power

The 16-layer development board has 10 signal layers and 6 ground/VCC planes. The board is powered from a single, well-regulated 16-V supply.

Regulators on the board are used to develop the V_{CCINT} (1.2 V), V_{CCIO} (3.3 V), and V_{CC5} (5.0 V) voltages. The board includes a Power-on LED that indicates the presence of V_{CCIO} .

The following board elements are powered by the 3.3 V supply:

- LEDs
- Switches
- Crystal oscillator

Table 3 lists the reference information for the 16-V power supply, which connects from the wall socket to the DSP development board.

Table 3. Power Supply Specifications	
Item	Description
Board reference	N/A (power supply adapter)
Part number	TR9KT3750LCP-Y
Device description	Switching power supply, Input: 100-240 V, ~1.2 A max., 50-60 Hz Output: +16 V, 3.75 A, 60 W max.
Manufacturer	GlobTek Inc.
Manufacturer web site	www.globtek.com

Clocks & Clock Distribution

Table 4 lists the clocks and their signal distribution throughout the board.

Table 4. Clock Distribution Signals (Part 1 of 3)		
Signal Name	Comes From	Goes To
dac_PLLCLK1	Stratix II device pin B15 (PLL5_OUT0p)	DAC A (U14 pin 28)
dac_PLLCLK1_n	Stratix II device pin C15 (PLL5_OUT0n)	DAC A (U14 pin 28)
dac_PLLCLK2	Stratix II device pin C16 (PLL5_OUT1p)	DAC B (U15 pin 28) (2)

Table 4. Clock Distribution Signals (Part 2 of 3)

Signal Name	Comes From	Goes To
dac_PLLCLK2_n	Stratix II device pin D16 (PLL5_OUT1n)	DAC B (U15 pin 28) (2)
sdram_CLK	Stratix II device pin AK16 (PLL6_OUT0p)	SDRAM (U39 U40 pins 68)
adc_PLLCLK1	Stratix II device pin B18 (PLL11_OUT0p)	ADC A (U1 pins 8, 7) (1)
adc_PLLCLK2	Stratix II device pin D18(PLL11_OUT0n)	ADC B (U2 pins 8, 7) (1)
audio_CLK	Stratix II device pin AL18(PLL12_OUT0p)	Audio CODEC (U5 pin 25)
pld_MICTORCLK	Stratix II device pin M25	Mictor Connector (J20 pin 5)
pld_CLKOUT	Stratix II device pin J14	PROTO1 (J25 pin 11) and PROTO2 (J28 pin 11) via a buffer (U7)
pld_CLKIN0,pld_CLKIN1	100-MHz oscillator	Stratix II device pins AM17 and A16
pld_CLKIN0_n,pld_CLKIN1_n	External CLKIN_n input (J11)	Stratix II device pins AL17 and B16
proto1_OSC, proto2_OSC	100-MHz oscillator	PROTO1 (J25 pin 9) and PROTO2 (J28 pin 9) via a buffer (U7)
cpd_CLKOSC	100-MHz oscillator	CPLD (U10 pin 125)
adc_CLK_IN1, adc_CLK_IN2	100-MHz oscillator	ADC A (U1 pins 8, 7) and B (U2 pins 8, 7) (1)
dac_CLKIN1, dac_CLKIN2	100-MHz oscillator	DAC A (U14 pin 28) and B (U15 pin 28) (2)
pld_CLKFB	pld_CLKOUT signal from the Stratix II pin J14	Stratix II device pin U1
adc_CLK_IN1_n, adc_CLK_IN2_n	External CLKIN_n input (J11)	ADC A (U1 pins 8, 7) and B (U2 pins 8, 7) (1)
dac_DACCLKIN1, dac_DACCLKIN2	External DA_EXT_CLK input (J12)	DAC A (U14 pin 28) and B (U15 pin 28) (2)
pld_DACCLKIN	External DA_EXT_CLK input (J12)	Stratix II device pin E16

Table 4. Clock Distribution Signals (Part 3 of 3)

Signal Name	Comes From	Goes To
proto1_CLKOUT, proto2_CLKOUT	PROTO1 (J25 pin 13) PROTO2 (J28 pin 13) via a buffer (U7)	Stratix II device pins T32 and T30

Notes to Table 4:

- (1) J3 and J4 control which clock is routed to the A/D converters. See [Table 10](#) for details.
- (2) J18 and J19 control which clock is routed to the D/A converters. See [Table 16](#) for details.

The Stratix II EP2S60 DSP development board can obtain a clock source from one or more of the following sources:

- The on-board crystal oscillator
- An external clock (through an SMA connector or a Stratix II pin)

The board can provide independent clocks from both the enhanced and fast PLLs to the A/D converters, the D/A converters, and the other components that require stable clock sources.

To implement this concept, the enhanced PLL5-dedicated pins drive the A/D converters and associated functions, and the enhanced PLL6-dedicated pins drive the D/A converters and associated functions.

Figure 3 is a diagram of each clock and their distribution throughout the board.

Figure 3. Clock Distribution

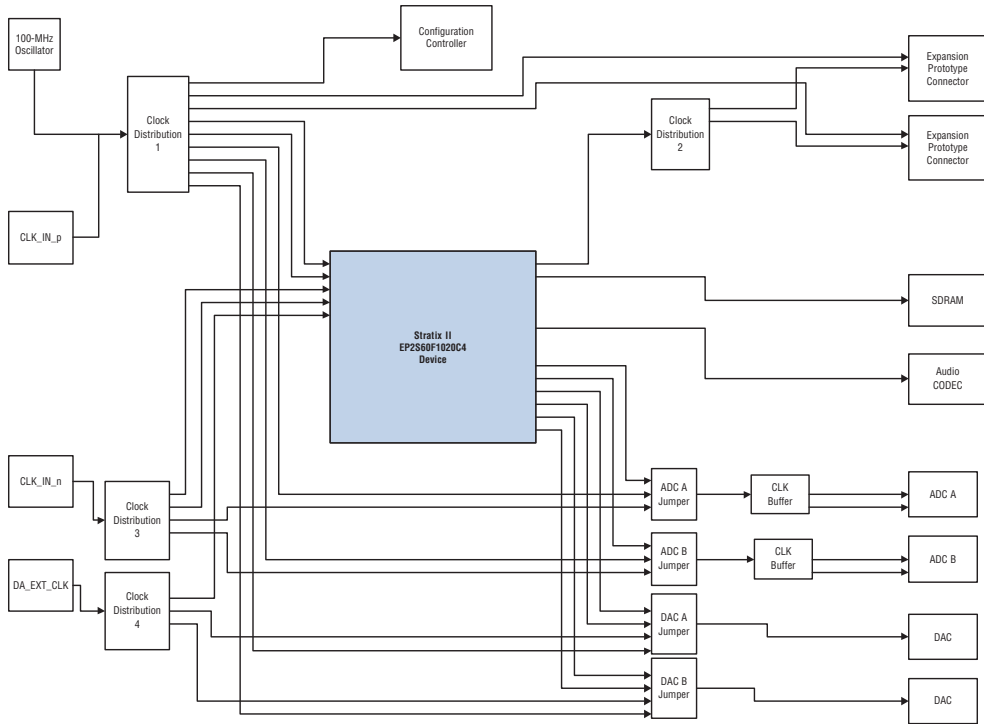

Table 5 lists the reference information for the 100-MHz socketed oscillator.

Table 5. 100-MHz Socketed Oscillator Reference	
Item	Description
Board reference	Y1
Part number	ECS-UPO-8PIN 100MHz
Device description	Oscillator
Manufacturer	ECS Inc.
Manufacturer web site	www.ecsxtal.com



Clock Distribution 1 source can be either the oscillator (Y1) or an external clock inserted using J10. To use an external clock signal, remove the crystal oscillator from its socket. Make sure to note the correct orientation of the oscillator before removing it.

Board Components

The following sections describe the development board components.

Stratix II Device (U18)

The Stratix II EP2S60 device on the board features 24,176 adaptive logic modules (ALMs) in a speed grade (-4) 1020-pin FineLine BGA® package. The device has 2,544,192 total RAM bits.



For more information on Stratix II devices, refer to the *Stratix II Device Handbook*.

Table 6 describes the features of the Stratix II EP2S60F1020C4 device.

Feature	EP2S60F1020
ALMs	24,176
Adaptive look-up tables (ALUTs)	48,352
M512 RAM Blocks (32 × 18 bits)	329
M4K RAM Blocks (128 × 36 bits)	255
M-RAM Blocks	2
Total RAM bits	2,544,192
DSP Blocks	36
Embedded multipliers (based on 18 × 18 mode of operation)	144
Enhanced PLLs	4
Fast PLLs	8
Maximum user I/O pins	717
Package type	1020-pin FineLine BGA
Board reference	U18
Voltage	1.2 V (internal), 3.3 V (I/O)

Switch Inputs

The board has four push-button switches for user-defined logic input. Each push-button signal when pressed, drives logic low and when released goes back to driving logic high.

Table 7 shows the pin-outs for the push-button switches.

<i>Table 7. Push-button Switch Pin-Outs</i>	
Signal Name	Stratix II Pin
SW4	K14
SW5	J15
SW6	L13
SW7	J13

Configuration-Status LEDs

The configuration controller is connected to four status LEDs that show the configuration status of the board at a glance. You can tell which configuration, if any, was loaded into the FPGA at power-on by looking at the LEDs. If a new configuration is downloaded into the Stratix II device via the JTAG interface, then the USER LED (LED1) remains illuminated. The rest of the configuration-status LEDs turn off if the unused pins are configured as inputs, tri-stated for the Stratix II device. [Table 8](#) shows the behavior of the configuration-status LEDs.

LED	LED Name	Color	Description
LED3	Loading	Green	This LED blinks while the configuration controller is actively transferring data from flash memory into the Stratix II FPGA.
LED4	Error	Red	If the red Error LED is on, then configuration was not transferred from flash memory into the Stratix II device. This can happen if, for example, the flash memory contains neither a valid user or factory configuration.
LED1	User	Green	This LED turns on when the user configuration is being transferred from flash memory and stays illuminated when the user configuration data is successfully loaded into the Stratix II device.
LED2	Factory	Amber	This LED turns on when the factory configuration is being transferred from flash memory and stays illuminated if the factory configuration was successfully loaded into the Stratix II device.

Dual Seven-Segment Display & LEDs

A dual seven-segment display and two LEDs are provided. The segments illuminate if the Stratix II pin to which they are connected drives low. They appear unlit when the connected Stratix II device pin drives high. The LEDs illuminate if the connected Stratix II device pin drives high, and are unlit when the connected Stratix II device pin drives low.

[Table 9](#) shows the pin-outs for the seven-segment display and LEDs.

Signal	Stratix II Pin
Dual Seven-Segment Display	
HEX_0A	C4
HEX_0B	C5
HEX_0C	B5

Table 9. Seven-Segment Display & LED Pin-Outs (Part 2 of 2)

Signal	Stratix II Pin
HEX_0D	B6
HEX_0E	D7
HEX_0F	C7
HEX_0G	B8
HEX_0DP	B9
HEX_1A	F9
HEX_1B	E9
HEX_1C	C10
HEX_1D	C11
HEX_1E	F11
HEX_1F	F12
HEX_1G	C12
HEX_1DP	B12
LEDs	
pld_LED0 (board designation: D1)	B4
pld_LED1 (board designation: D2)	D5
pld_LED2 (board designation: D3)	E5
pld_LED3 (board designation: D4)	A4
pld_LED4 (board designation: D5)	A5
pld_LED5 (board designation: D6)	D6
pld_LED6 (board designation: D7)	C6
pld_LED7 (board designation: D8)	A6

Figure 4 shows the pin-outs for the seven-segment display.

Figure 4. Pin-Out Diagram for the Dual Seven-Segment Display

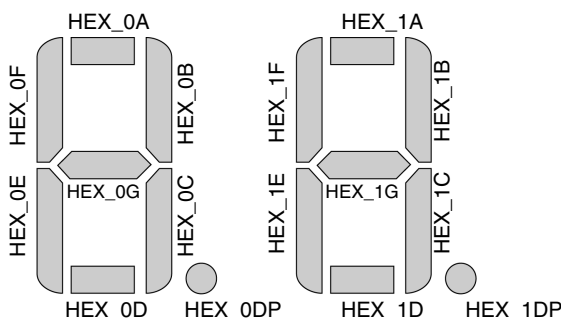

A/D Converters

The Stratix II EP2S60 DSP development board has two 12-bit A/D converters that produce samples at a maximum rate of 125 mega-samples per second (MSPS). The A/D subsystem of the board has the following features:

- The data output format from each A/D converter to the Stratix II device is in two's complement format.
- The circuit has a wideband, AC-coupled, differential input useful for IF sampling. The analog inputs are transformer-coupled to the A/D converter in order to create a balanced input. To maximize performance, two transformers are used in series. The Analog Devices data sheet for the AD9433 device describes the detailed operation of this circuit.
- Any required anti-aliasing filtering can be installed externally. If needed, users can purchase in-line SMA filters from a variety of manufacturers, such as Mini-Circuits (www.minicircuits.com).



The transformer-coupled AC circuit has a lower 3-dB frequency, of approximately 1 MHz.

The clock signal that drives the A/D converters can originate from the Stratix II device, the external clock input, or the on-board 100-MHz oscillator. Jumper J3 controls which clock is used for ADC A and J4 is used

to select the clock for ADC B. [Table 10](#) explains how to select these three clock signals. The selected clock will pass through a differential LVPECL buffer before arriving at the clock input to both A/D converters

J3, J4 Setting	Clock Source	Signal Name
Pins 1 and 2	Stratix II PLL circuitry	adc_PLLCLK1, adc_PLLCLK2
Pins 3 and 4	OSC or External input clock positive	adc_CLK_IN1, adc_CLK_IN2
Pins 5 and 6	OSC or External input clock negative	adc_CLK_IN1_n, adc_CLK_IN2_n

[Table 11](#) lists reference information for the A/D converters.

Item	Description
Board reference	U1, U2
Part number	AD9433BSQ
Device description	12-bit, 125-MSPS A/D converter
Voltage	3.3-V digital V_{DD} , 5.0-V analog V_{DD}
Manufacturer	Analog Devices
Manufacturer web site	www.analog.com

A/D Converter Stratix II Pin-Outs

Tables 12 and 13 show the ADC A (U1) and ADC B (U2) Stratix II pin-outs.

Table 12. ADC A (U1) Stratix II Pin-Outs

Signal Name	Stratix II Pin
adcA_D0 (LSB)	D1
adcA_D1	D2
adcA_D2	E3
adcA_D3	E4
adcA_D4	E1
adcA_D5	E2
adcA_D6	F3
adcA_D7	F4
adcA_D8	F1
adcA_D9	F2
adcA_D10	G3
adcA_D11 (MSB)	G4

Table 13. ADC B (U2) Stratix II Pin-Outs

Signal Name	Stratix II Pin
adcB_D0 (LSB)	G1
adcB_D1	G2
adcB_D2	J3
adcB_D3	J4
adcB_D4	H1
adcB_D5	H2
adcB_D6	J1
adcB_D7	J2
adcB_D8	K3
adcB_D9	K4
adcB_D10	K1
adcB_D11 (MSB)	K2

D/A Converters

The Stratix II EP2S60 DSP development board has two D/A converters. The D/A subsystem of the board has the following features:

- The converters produce 14-bit samples at a maximum rate of 165 MSPS.
- The analog output from each D/A converter is single-ended.

 The D/A converters expect data in an unsigned integer format.

The D/A clock signals are output directly from the Stratix II device to the converters.

Figure 5 shows the on-board circuitry after a D/A converter. The output of a D/A converter chip, DAC904, consists of a current source whose maximum value is 20 mA. This output is connected to ground on the board using a 51- Ω resistor, creating a Thevenin equivalent voltage source of 1 V in series with a 51- Ω resistor. When loaded with an external 50- Ω termination, the output swing is reduced to 0.5 V_{PP}. Additionally, there is a 27-pF capacitor in parallel with the output resistor resulting in a single-pole, low-pass filter with an upper 3-dB frequency of approximately 230 MHz when externally loaded. The output is then brought to an SMA connector.

Figure 5. On-Board Circuitry after D/A Converter

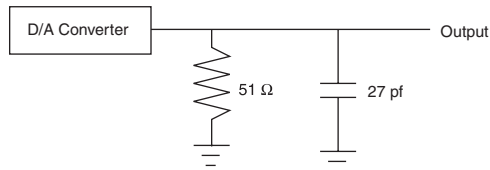

 The development kit includes an SLP-50 anti-aliasing filter from Mini-Circuits. This filter provides a 55-MHz cut-off frequency. For systems with other bandwidth requirements, a variety of anti-aliasing filters are available from commercial manufacturers to suit the system requirements.

Table 14 shows the reference information for the anti-aliasing filter.

Table 14. Anti-Aliasing Filter Reference	
Item	Description
Board reference	N/A
Manufacturer	Mini-circuits
Description	Anti-aliasing filter
Part number	SLP-50
Manufacturer web site	www.minicircuits.com

Table 15 lists reference information for the D/A converters.

Table 15. D/A Converter Reference	
Item	Description
Board reference	U14, U15
Part number	DAC904
Device description	14-bit, 165-MSPS D/A converter
Voltage	3.3-V digital V_{DD} , 5.0-V analog V_{DD}
Manufacturer	Texas Instruments
Manufacturer web site	www.ti.com

Table 16 lists the clock source settings for the D/A converters.

Table 16. D/A Clock Source Settings		
J18, J19 Setting	Clock Source	Signal Name
Pins 1 and 2	Stratix II PLL Circuitry	dac_PLLCLK1, dac_PLLCLK2
Pins 3 and 4	Stratix II PLL Circuitry	dac_PLLCLK1_n, dac_PLLCLK2_n
Pins 5 and 6	OSC or External input clock (J10)	dac_CLK_IN1, dac_CLK_IN2
Pins 7 and 8	External input clock (J12) DA EXT CLK	dac_DACCLKIN1, dac_DACCLKIN2

D/A Converter Stratix II Pin-Outs

Tables 17 and 18 show the DAC A (U14) and DAC B (U15) Stratix II pin-outs.

Table 17. D/A A (U14, J15) Stratix II Pin-Outs	
Signal Name	Stratix II Pin
dacA_D1 (MSB)	U5
dacA_D2	U6
dacA_D3	U10
dacA_D4	U11
dacA_D5	V9
dacA_D6	V10
dacA_D7	V6
dacA_D8	V7
dacA_D9	V4
dacA_D10	V5
dacA_D11	W8
dacA_D12	W9
dacA_D13	W6
dacA_D14 (LSB)	W7

Signal Name	Stratix II Pin
dacB_D1 (MSB) (1)	W4
dacB_D2	W5
dacB_D3	Y6
dacB_D4	Y7
dacB_D5	Y8
dacB_D6	Y9
dacB_D7	Y10
dacB_D8	Y11
dacB_D9	AB5
dacB_D10	AB6
dacB_D11	AA10
dacB_D12	AA11
dacB_D13	AA6
dacB_D14 (LSB)	AA7

Note to Table 18:

- (1) The Texas Instruments (TI) naming conventions differ from those of Altera Corporation. The TI data sheet for the DAC 904 D/A converter lists bit 1 as the most significant bit (MSB) and bit 14 as the least significant bit (LSB).

SRAM Memory (U43 & U44)

U43 and U44 are two 256 Kbyte x 16-bit asynchronous SRAM devices. They are connected to the Stratix II device so they can be used by a Nios® II embedded processor as general-purpose memory. The two 16-bit devices can be used in parallel to implement a 32-bit wide memory subsystem.

Table 19 lists the reference information for the SRAM memory.

Item	Description
Board reference	U43, U44
Part Number	IDT71V416S10PH
Device description	SRAM Memory
Manufacturer	IDT
Manufacturer web site	www.idt.com

Flash Memory (U17)

U17 is a 16-Mbyte AMD AM29LV128M flash memory device connected to the Stratix II device. It can be used for two purposes:

- A Nios II embedded processor implemented in the Stratix II device can use the flash as general-purpose readable memory and non-volatile storage.
- The flash memory can hold a Stratix II device configuration file that is used by the configuration controller to load the Stratix II device at power-up.

Hardware configuration data that implements the Nios II reference design is pre-stored in this flash memory. The factory programmed Nios II reference design, once loaded, can identify the 16-Mbyte flash memory in its address space, and can program new data (either new Stratix II configuration data, Nios II embedded processor software, or both) into flash memory. The Nios II embedded processor software includes subroutines for writing and erasing this specific type of AMD flash memory.

Table 20 lists the reference information for the Flash memory.

Table 20. Flash Memory Reference	
Item	Description
Board reference	U17
Part number	AM29LV128MH103REI
Device description	Flash Memory
Manufacturer	AMD
Manufacturer web site	www.amd.com

SDRAM Memory (U39 and U40)

The SDRAM devices (U39 and U40) are 2 Micron MT48LC4M32B2 devices with PC100 functionality and self refresh mode. The SDRAM is fully synchronous with all signals registered on the positive edge of the system clock.

The SDRAM device pins are connected to the Stratix II device. An SDRAM controller peripheral is included with the Stratix II DSP Development Kit, allowing a Nios II processor to view the SDRAM devices as a large, linearly-addressable memory.

Table 21 lists the Stratix II device pin-outs for SDRAM device U39.

Table 21. SDRAM Device (U39) Pin-Outs (Part 1 of 2)		
Pin Name	Pin Number	Connects to Stratix II Pin
A0	25	AD11
A1	26	AD13
A2	27	AB13
A3	60	AE14
A4	61	AB14
A5	62	AC14
A6	63	AD14
A7	64	AE10
A8	65	AB15
A9	66	AC16
A10	24	AB16
A11	21	AE13
BA0	22	AL9
BA1	23	AF11
DQ0	2	AL4
DQ1	4	AJ5
DQ2	5	AH5
DQ3	7	AM4
DQ4	8	AG9
DQ5	10	AH6
DQ6	11	AH7
DQ7	13	AH9
DQ8	74	AM5
DQ9	76	AK6
DQ10	77	AJ6
DQ11	79	AM6
DQ12	80	AM7
DQ13	82	AK7
DQ14	83	AJ7
DQ15	85	AM8
DQ16	31	AJ10
DQ17	33	AK8

Table 21. SDRAM Device (U39) Pin-Outs (Part 2 of 2)		
Pin Name	Pin Number	Connects to Stratix II Pin
DQ18	34	AJ8
DQ19	36	AM9
DQ20	37	AF12
DQ21	39	AG10
DQ22	40	AF10
DQ23	42	AG12
DQ24	45	AJ11
DQ25	47	AH11
DQ26	48	AL10
DQ27	50	AM10
DQ28	51	AK12
DQ29	53	AJ12
DQ30	54	AM11
DQ31	56	AM12
DQM0	16	AK5
DQM1	71	AG8
DQM2	28	AH8
DQM3	59	AL5
RAS_N	19	AK4
CAS_N	18	AL8
CKE	67	AL7
CS_N	20	AL6
WE_N	17	AK9
CLK	68	AK16

Table 22 lists the Stratix II device pin-outs for SDRAM device U40.

Table 22. SDRAM Device (U40) Pin-Outs (Part 1 of 3)		
Pin Name	Pin Number	Connects to Stratix II Pin
A0	25	AD11
A1	26	AD13
A2	27	AB13
A3	60	AE14
A4	61	AB14

Table 22. SDRAM Device (U40) Pin-Outs (Part 2 of 3)

Pin Name	Pin Number	Connects to Stratix II Pin
A5	62	AC14
A6	63	AD14
A7	64	AE10
A8	65	AB15
A9	66	AC16
A10	24	AB16
A11	21	AE13
BA0	22	AL9
BA1	23	AF11
DQ0	2	AH13
DQ1	4	AG13
DQ2	5	AF13
DQ3	7	AG15
DQ4	8	AL14
DQ5	10	AJ14
DQ6	11	AJ13
DQ7	13	AM14
DQ8	74	AL20
DQ9	76	AH19
DQ10	77	AJ19
DQ11	79	AH20
DQ12	80	AM21
DQ13	82	AK21
DQ14	83	AJ21
DQ15	85	AM22
DQ16	31	AJ23
DQ17	33	AK22
DQ18	34	AG22
DQ19	36	AG23
DQ20	37	AM23
DQ21	39	AK23
DQ22	40	AK24
DQ23	42	AM24
DQ24	45	AK25

Table 22. SDRAM Device (U40) Pin-Outs (Part 3 of 3)

Pin Name	Pin Number	Connects to Stratix II Pin
DQ25	47	AH24
DQ26	48	AH26
DQ27	50	AG24
DQ28	51	AM26
DQ29	53	AM25
DQ30	54	AJ26
DQ31	56	AK26
DQM0	16	AK13
DQM1	71	AL13
DQM2	28	AB12
DQM3	59	AC12
RAS_N	19	AK4
CAS_N	18	AL8
CKE	67	AL7
CS_N	20	AL6

Table 23 lists the reference information for the SDRAM memory.

Table 23. SDRAM Memory Reference

Item	Description
Board reference	U39, U40
Part number	MT48LC4M32B2TG-7
Device description	SDRAM Memory
Manufacturer	Micron
Manufacturer web site	www.micron.com

Ethernet MAC/PHY (U16)

The LAN91C111 (U16) is a mixed signal analog/digital device that implements protocols at 10 Mbps and 100 Mbps. The control pins of U16 are connected to the Stratix II device so that user logic (e.g., the Nios II processor) can access Ethernet via the RJ-45 connector (RJ1).

Table 24 lists the reference information for the Ethernet MAC/PHY.

Table 24. Ethernet MAC/PHY Reference	
Item	Description
Board reference	U16
Part Number	LAN91C111-NE
Device description	Ethernet MAC/PHY
Manufacturer	SMSC
Manufacturer web site	www.smsc.com

CompactFlash Connector (CON1)

The CompactFlash connector header (CON1) enables hardware designs to access a CompactFlash card. The following two access modes are supported:

- ATA (hot-swappable mode)
- IDE (IDE hard-disk mode)

Most pins of CON1 connect to I/O pins on the FPGA. The following pins have special connections:

- Pin 13 of CON1 (VCC) is driven by a power MOSFET that is controlled by an FPGA I/O pin. This allows the FPGA to control power to the CompactFlash card for the IDE connection mode.
- Pin 26 of CON1 (CD1#) is pulled up to 5V through a 10-K Ω resistor. This signal is used to detect the presence of a CompactFlash card. When the card is not present, the signal is pulled high through the pull-up resistor.
- Pin 41 of CON1 (RESET) is pulled up to 5V through a 10-K Ω resistor, and is controlled by the EPM7128AE configuration controller. The FPGA can cause the configuration controller to assert RESET, but the FPGA does not drive this signal directly.

Table 25 provides CompactFlash pin-out details.

Table 25. CompactFlash (CON1) Pin Table (Part 1 of 2)		
Pin on CompactFlash (CON1)	CompactFlash Function (U60)	Connects to (1)
1	GND	GND
2	D03	AA3
3	D04	AA1
4	D05	Y2
5	D06	W1
6	D07	V2
7	CS0#	AE3
8	A10	AF1
9	ATA_SEL#	AD12
10	A09	AF3
11	A08	AF4
12	A07	AG1
13	VCC	V _{CC} (2)
14	A06	AD6
15	A05	AD7
16	A04	AA8
17	A03	AA9
18	A02	AE2
19	A01	AD2
20	A00	AE1
21	DO0	AB3
22	DO1	AB1
23	DO2	Y4
24	IOCS16#	AD1
25	CD2#	AB8 (3)
26	CD1#	AC15
27	D11	AA2
28	D12	AA4
29	D13	Y5
30	D14	AB2
31	D15	AB4
32	CS1#	AC9

Table 25. CompactFlash (CON1) Pin Table (Part 2 of 2)		
Pin on CompactFlash (CON1)	CompactFlash Function (U60)	Connects to (1)
33	VS1#	AB10
34	IOR#	AC2
35	IOWR#	AC1
36	WE#	AC6
37	INTRQ	AC4
38	VCC	V _{CC} (2)
39	CSEL#	AC8
40	VS2#	AB9
41	RESET (4)	AE12
42	WAIT#	AC3
43	INPACK#	AC7
44	REG#	AB7
45	DASP#	AE4
46	PDIAG#	AF2
47	DO8	V3
48	DO9	W2
49	D10	Y3
50	VSS	GND (3)

Notes to Table 25:

- (1) All pin numbers represent I/O pins on the FPGA, unless otherwise noted.
- (2) This FPGA I/O pin controls a power MOSFET that supplies 5V V_{CC} to CON1.
- (3) This pin does not connect to the FPGA directly.
- (4) RESET is driven by the EPM7256AE configuration controller device.

Table 26 lists the reference information for the CompactFlash connector..

Table 26. CompactFlash Connector Reference	
Item	Description
Board reference	CON1
Part Number	53856-5010
Device description	CompactFlash connector
Manufacturer	Molex
Manufacturer web site	www.molex.com



For general information on CompactFlash, see www.compactflash.org.

Mictor Connector (J20)

The Mictor connector (J20) can be used to transmit up to 27 high-speed I/O signals with very low noise via a shielded Mictor cable. J20 is used as a debug port. Twenty-five of the Mictor connector signals are used as data, and two signals are used as clock input and clock output.

Most pins on J20 connect to I/O pins on the Stratix II device (U18). For systems that do not use the Mictor connector for debugging the Nios II processor, any on-chip signals can be routed to I/O pins and probed at J20 via a Mictor cable. External scopes and logic analyzers can connect to J20 and analyze a large number of signals simultaneously.



For details on Nios II debugging products that use the Mictor connector, see www.altera.com.

Figure 6 shows an example of an in-target system analyzer ISA-Nios/T (sold separately) by First Silicon Solutions (FS2) Inc. connected to the Mictor connector. For details see www.fs2.com.

Figure 6. An ISA-Nios/T Connecting to the Mictor Connector (J20)

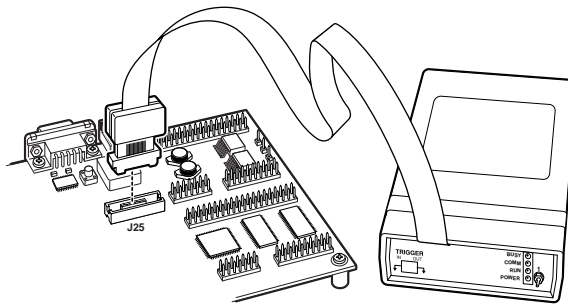

Five of the signals connect to both the JTAG pins on the Stratix II device (U18) and the Stratix II device's JTAG connector (J24). The JTAG signals have special usage requirements. You cannot use J20 and J24 at the same time.

Figure 7 below shows connections from the Mictor connector to the Stratix II device. Figure 8 shows the pin-out for J20. Unless otherwise noted, labels indicate Stratix II device pin numbers.

Figure 7. Mictor Connector Signaling

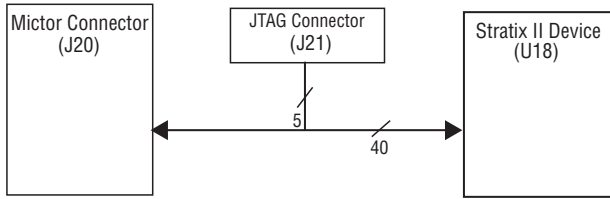

Figure 8. Debug Mictor Connector - J20

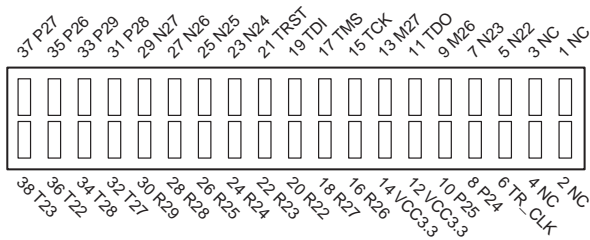

Table 27 lists the reference information for the Mictor connector.

Table 27. Mictor Connector Reference	
Item	Description
Board reference	J20
Part number	2-767004-2
Device description	Mictor connector
Manufacturer	Tyco
Manufacturer web site	www.tyco.com

VGA Interface (J35)

The board contains a high density DP15 connector, which outputs VGA, as well as a Triple Video D/A converter which has the following features:

- 3 x 8 bit, 180 megapixels per second
- ±2.5% gain matching
- ±0.5 LSB linearity error
- Internal bandgap voltage reference
- Low glitch energy

- Single 3.3-V power supply

Table 28 shows the pin-outs for the VGA interface.

Signal	Stratix II Pin
vga_B0	B7
vga_B1	E7
vga_B2	E6
vga_B3	A7
vga_B4	C9
vga_B5	A8
vga_B6	C8
vga_B7	A9
vga_G0	E11
vga_G1	G10
vga_G2	G11
vga_G3	G12
vga_G4	D12
vga_G5	A11
vga_G6	B11
vga_G7	A12
vga_R0	D8
vga_R1	E8
vga_R2	F8
vga_R3	F10
vga_R4	A10
vga_R5	B10
vga_R6	D10
vga_R7	D11
vga_BLANK_n	G13
vga_CLOCK	E13
vga_HSYNC	F15
vga_VSYNC	B14
vga_SYNC_n	F13

Table 29 describes the device used to implement the VGA interface.

Table 29. VGA Interface Device Reference	
Item	Description
Board reference	U45
Part number	FMS3818KRC
Device description	Triple Video D/A Converter
Voltage	3.3 V
Manufacturer	Fairchild
Manufacturer web site	www.fairchildsemi.com

Audio CODEC (U5)

The board contains three stereo jack connectors, which serve as one stereo input, one amplified stereo output and one non-amplified stereo output. The stereo jacks are driven by a Stereo Audio CODEC running at 8-96 KHz. Table 30 shows the pin-outs for the CODEC.

Table 30. Audio CODEC (U5) Pin-Outs	
Signal	Stratix II Pin
audio_BCLK	AG4
audio_CS_n	AH1
audio_SDIN	AH2
audio_SCLK	AH3
audio_MODE	AH4
audio_DOUT	AJ1
audio_DIN	AJ2
audio_LRCIN	AG2
audio_LRCOUT	AG3
audio_CLK	AL18

Table 31 describes the device used to implement the CODEC.

Table 31. Audio CODEC Device Reference	
Item	Description
Board reference	U5
Part number	TLV320AIC23PW
Device description	Stereo Audio CODEC, 8-96 KHz
Voltage	3.3 V
Manufacturer	Texas Instruments
Manufacturer web site	www.ti.com

Expansion Interfaces

The Stratix II EP2S60 DSP development board includes the following interfaces:

- A TI-EVM/FPDP connector (J31, J33), located on the reverse side of the board
- An RS-232C Serial I/O interface (J29)
- Two 0.1-inch headers specifically designed to be used with external analog-to-digital devices made by Analog Devices Corporation (J6, J5)
- Two Altera Expansion Prototype Connectors (J23, J24, J25; J26, J27, J28)

TI-EVM/FPDP Connector (J31, J33)

The TI-EVM interface is specifically designed to work with TI boards that have the EVM interface. Refer to the Texas Instruments web site for details on which of their boards feature this connector.

Table 32 lists the pin-outs for the TI-EVM and FPDP connectors.

Table 32. TI-EVM /FPDP Connector (J31, J33) Pin-Outs (Part 1 of 4)	
TI-EVM Signal Name	Stratix II Pin
J31	
evm_DX0	J21
evm_DR0	H22
evm_IAK	K12
evm_INUM0	H13

Table 32. TI-EVM /FPDP Connector (J31, J33) Pin-Outs (Part 2 of 4)

TI-EVM Signal Name	Stratix II Pin
evm_CNTL0	L12
evm_STAT0	J12
evm_DMAC0	H12
evm_CLKOUT2	K11
evm_CLKX0	J22
evm_FSX0	G22
evm_CLKR0	K22
evm_FSR0	K21
evm_RESET	J11
evm_INT0	H11
evm_INT1	L14
evm_INT2	C13
evm_INT3	B13
J33	
evm_A2	B20
evm_A3	E19
evm_A4	C20
evm_A5	E20
evm_A6	A21
evm_A7	C21
evm_A8	A22
evm_A9	C22
evm_A10	D23
evm_A11	D21
evm_A12	F22
evm_A13	F23
evm_A14	A23
evm_A15	C23
evm_A16	C24
evm_A17	A24
evm_A18	A25
evm_A19	A26
evm_A20	D26

Table 32. TI-EVM /FPDP Connector (J31, J33) Pin-Outs (Part 3 of 4)

TI-EVM Signal Name	Stratix II Pin
evm_A21	C26
evm_D0	E24
evm_D1	C25
evm_D2	E27
evm_D3	E26
evm_D4	A27
evm_D5	A28
evm_D6	D27
evm_D7	C27
evm_D8	B29
evm_D9	A29
evm_D10	D28
evm_D11	E28
evm_D12	D19
evm_D13	B21
evm_D14	D22
evm_D15	B23
evm_D16	B25
evm_D17	D25
evm_D18	B27
evm_D19	C28
evm_D20	D20
evm_D21	B22
evm_D22	E22
evm_D23	B24
evm_D24	B26
evm_D25	E25
evm_D26	B28
evm_D27	C29
evm_D28	L21
evm_D29	G21
evm_D30	L18
evm_D31	J19

Table 32. TI-EVM /FPDP Connector (J31, J33) Pin-Outs (Part 4 of 4)

TI-EVM Signal Name	Stratix II Pin
evm_BE_n0	H20
evm_BE_n1	L19
evm_BE_n2	K19
evm_BE_n3	G20
evm_AWE_n	L20
evm_ARDY	H21
evm_ACE2_n	J20
evm_ARE_n	K20
evm_AOE_n	K18
evm_ACE3_n	E14

RS-232C Serial I/O Interface

The board contains a DB9 connector (J29), which provides a bidirectional RS-232C serial I/O interface. The board contains the transceiver (U41), however the logic controller (UART) must be implemented in the Stratix II device. [Table 34](#) describes the device used to implement the RS-232C interface.

J29 is a standard DB-9 serial connector. This connector is typically used for communication with a host computer using a standard 9-pin serial cable connected to (for example) a COM port. Level-shifting buffers (U52 and U58) are used between J29 and the Stratix II device, because the Stratix II device cannot interface to RS-232 voltage levels directly.

J29 is able to transmit all RS-232 signals. The Stratix II design may use only the signals it needs, such as J29's RXD and TXD. LEDs are connected to the RXD and TXD signals, giving a visual indication when data is being transmitted or received. [Figure 9](#) shows the pin connections between the serial connector and the Stratix II device.

Figure 9. Serial Connector J29

Table 33 shows the pin-outs for the RS-232C interface.

Signal	Stratix II Pin
TXD	L17
RXD	L16
DTR	K13
DCD	H14
DSR	K16
RI	K17
CTS	K15
RTS	L15

Table 34 lists reference information for the RS-232C transceiver device.

Item	Description
Board reference	U41
Part number	MAX221E
Device description	RS-232 transceiver
Voltage	3.3 V
Manufacturer	Maxim
Manufacturer web site	www.maxim-ic.com

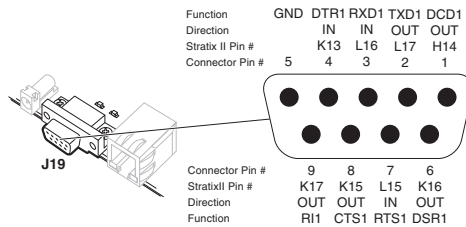
Analog Devices Corporation External A/D Support

The Stratix II EP2S60 DSP development board supports Analog Devices A/D converters via two 40-pin 0.1-inch digital I/O headers (J5, J6). These two dual-purpose digital I/O headers can support a maximum of the following three converters.

- Two AD9433 converters
- Two AD6645 converters
- One AD9430 converter

Table 35 lists the pin-outs for the ADI connectors.

<i>Table 35. ADI Connector (J5, J6) Pin-Outs (Part 1 of 2)</i>	
ADI Signal Name	Stratix II Pin
Adi_D0	L3
Adi_D1	L4
Adi_D2	N4
Adi_D3	N5
Adi_D4	M3
Adi_D5	M4
Adi_D6	L1
Adi_D7	L2
Adi_D8	N2
Adi_D9	N3
Adi_D10	M1
Adi_D11	M2
Adi_D12	R2
Adi_D13	R3
Adi_D14	P1
Adi_D15	P2
Adi_D16	J6
Adi_D17	J7
Adi_D18	J8
Adi_D19	J9
Adi_D20	K8
Adi_D21	K9
Adi_D22	L9
Adi_D23	L10

Table 35. ADI Connector (J5, J6) Pin-Outs (Part 2 of 2)

ADI Signal Name	Stratix II Pin
Adi_D24	L7
Adi_D25	L8
Adi_D26	K6
Adi_D27	K7
Adi_D28	L5
Adi_D29	L6
Adi_D30	M10
Adi_D31	M11
Adi_D32	M8
Adi_D33	M9

Expansion Prototype Connector (J23, J24, J25)

Headers J23, J24, and J25 collectively form a standard-footprint, mechanically-stable connection that can be used (for example) as an interface to a special-function daughter card.



For a list of available expansion daughter cards that can be used with the Stratix II EP2S60 DSP development board refer to www.altera.com/devkits.

The expansion prototype connector interfaces include:

- 41 I/O pins for prototyping. All 41 I/O pins connect to user I/O pins on the Stratix II device. Each signal passes through analog switches (U19, U20, U21, U22 and U25) to protect the Stratix II device from 5 V logic levels. These analog switches are permanently enabled. The output logic-level on the expansion prototype connector pins is 3.3 V.
- A buffered, zero-skew copy of the on-board OSC output from U2.
- A buffered, zero-skew copy of the Stratix II device's phase-locked loop (PLL)-output from U60.
- A logic-negative power-on reset signal.
- Five regulated 3.3-V power-supply pins (2 A total maximum load for both connectors).
- One regulated 5-V power-supply pin (1 A total maximum load for both connectors).
- Numerous ground connections.

Figures 10 and 11 show connections from the expansion prototype connector to the Stratix II device. Unless otherwise noted, labels indicate Stratix II device pin numbers.

Figure 10. Expansion Prototype Connector - J23, J24, J25

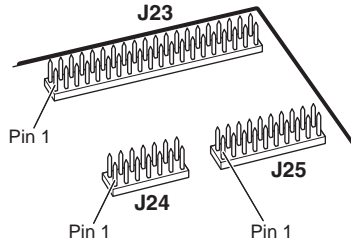

Figure 11. Expansion Prototype Connector Pin Information - J23, J24, J25

J23	
2	GND
4	R30
6	F31
8	M31
10	N30
12	L31
14	M29
16	N28
18	L29
20	NC
22	GND
24	GND
26	GND
28	J32
30	GND
32	H31
34	NC
36	F32
38	L26
40	GND

J24	
2	VCC5
4	E31
6	H29
8	G29
10	F29
12	E29
14	D31

J25	
2	GND
4	GND
6	GND
8	GND
10	GND
12	GND
14	GND
16	GND
18	GND
20	GND

J23 (continued)	
1	RESET_n
3	R31
5	R32
7	M32
9	N31
11	L32
13	M30
15	N29
17	L30
19	GND
21	K32
23	K31
25	K30
27	K29
29	J31
31	H32
33	G32
35	G31
37	F31
39	E32

J24 (continued)	
1	GND
3	M24
5	H30
7	G30
9	F30
11	E30
13	D32

J25 (continued)	
1	(1) Vunreg (U54 pin 2)
3	NC
5	+3.3V
7	+3.3V
9	(2) PROTO1_OSC (U2 pin 6)
11	(3) PROTO1_CLKIN (U2 pin 17)
13	(4) PROTO1_CLKOUT (AC14)
15	+3.3V
17	+3.3V
19	+3.3V

Notes to Figure 11:

- (1) Unregulated voltage from AC to DC power transformer
- (2) Clk from board oscillator
- (3) Clk from the Stratix II device via buffer
- (4) Clk output from the card to the Stratix II device

Expansion Prototype Connector (J26, J27, J28)

Headers J26, J27, and J28 collectively form a standard-footprint, mechanically-stable connection that can be used (for example) as an interface to a special-function daughter card.

The expansion prototype connector interface includes:

- 41 I/O pins for prototyping. All 41 I/O pins connect to user I/O pins on the Stratix II device. Each signal passes through analog switches (U27, U28, U29, U30 and U31) to protect the Stratix II device from 5-V logic levels. These analog switches are permanently enabled. The output logic-level on the expansion prototype connector pins is 3.3 V.
- A buffered, zero-skew copy of the on-board OSC output (from U2).
- A buffered, zero-skew copy of the Stratix II device's phase-locked loop (PLL)-output (from U60).
- A logic-negative, power-on reset signal.
- Five regulated 3.3-V power-supply pins (2A total max load for both expansion prototype connectors).
- One regulated 5-V power-supply pin (1A total max load for both expansion prototype connectors).
- Numerous ground connections.

Figures 12 and 13 show connections from the expansion prototype to the Stratix II device. Unless otherwise noted, the labels indicate Stratix II device pin numbers.

Figure 12. Expansion Prototype Connector - J26, J27, J28

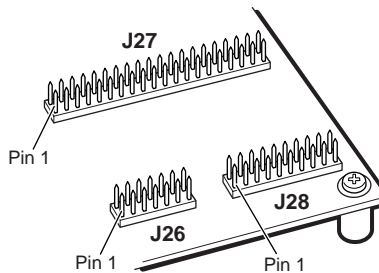
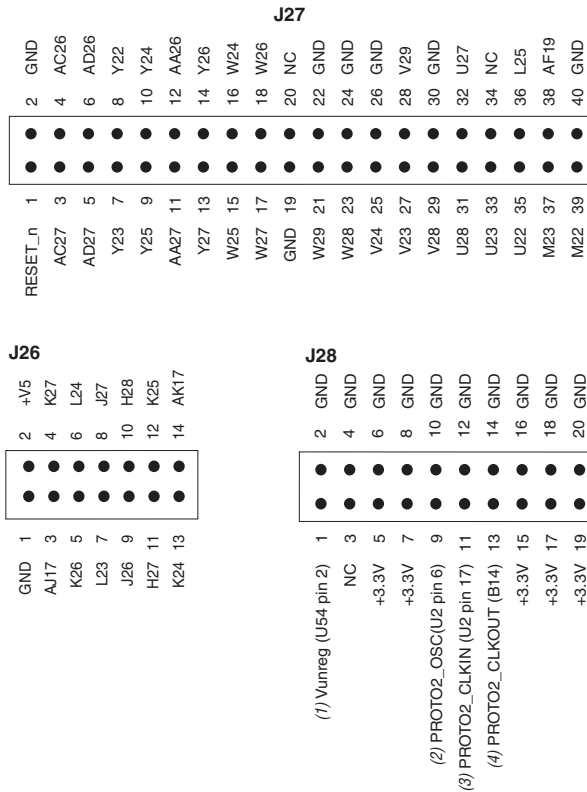

Figure 13. Expansion Prototype Connector -Pin Information for J26, J27, & J28



Notes to Figure 13:

- (1) Unregulated voltage from AC to DC power transformer
- (2) Clk from board oscillator
- (3) Clk from the Stratix II device via buffer
- (4) Clk output from card connected to the Stratix II device.

Install the Active Heat Sink

The DSP Development Kit, Stratix II Edition includes a heat sink and fan combination, also known as an active heat sink. This active heat sink maintains the Stratix II device within its thermal operating range, independent of the design size, clock frequency, and operating conditions, allowing you to evaluate larger high-speed designs in hardware before completing the thermal analysis of your system. Depending on the specific requirements of your application, this level of cooling may not be necessary.



For further information, refer to *Application Note 355: Stratix II Device System Power Considerations*.

To mount the active heat sink to the board, perform the following steps:

1. Center the heat sink on top of the Stratix II FPGA. The active heat sink can be mounted in two directions; mount it so the wires are as close as possible to the J36 connector. When connected, these wires supply the 5 V DC power to the fan.
2. Tilt the heat sink as shown in [Figure 14](#), and attach the clip under the FPGA.

Figure 14. Tilt the Heat Sink

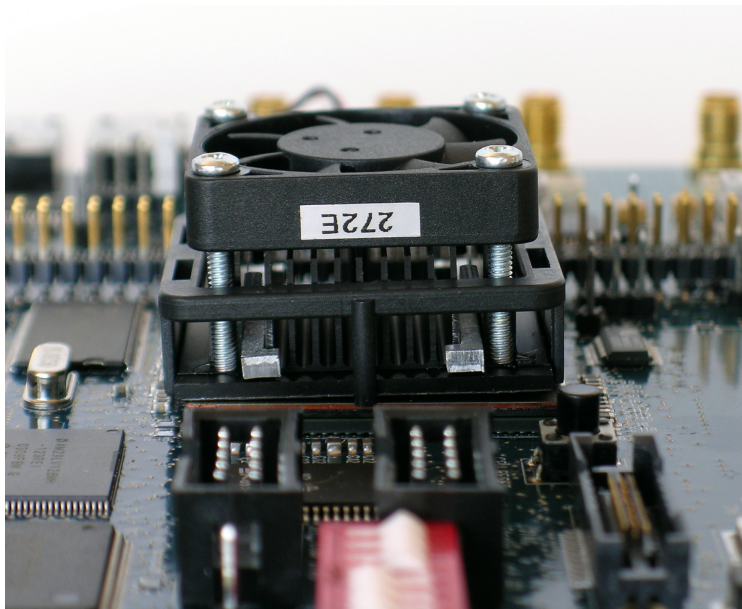

3. Insert a thin, flat tool (small flat-head screwdriver, tweezers, or any clip tool) into the clip's pry hole, and use it to gently push the clip on the edge of the FPGA. Snap the clip down to secure the heat sink. See [Figure 15](#).

Figure 15. Attach the Clip

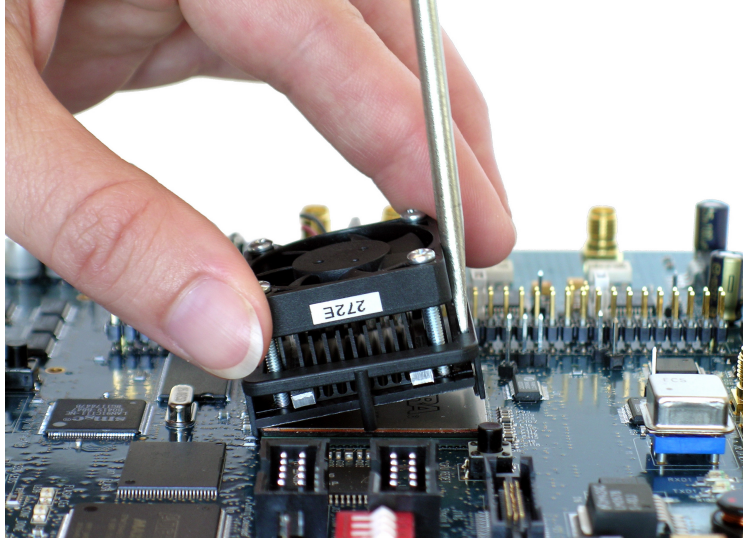

4. Attach the heat sink fan power connector to the J36 connector, for 5 V DC power.

Remove the Active Heat Sink

To remove the heat sink and fan from the board, perform the following steps:

1. Disconnect the heat sink fan power connector from the J36 connector.
2. Insert the thin, flat tool into one of the clip's pry holes. Using the tool, slightly push away and lift the plastic clip from the FPGA to detach one side of the heat sink.
3. Repeat step 2 on the other side of the plastic clip to remove the heat sink completely.



101 Innovation Drive
San Jose, CA 95134
(408) 544-7000
www.altera.com
Applications Hotline:
(800) 800-EPLD
Literature Services:
lit_req@altera.com

Copyright © 2004 Altera Corporation. All rights reserved. Altera, The Programmable Solutions Company, the stylized Altera logo, specific device designations, and all other words and logos that are identified as trademarks and/or service marks are, unless noted otherwise, the trademarks and service marks of Altera Corporation in the U.S. and other countries. All other product or service names are the property of their respective holders. Altera products are protected under numerous U.S. and foreign patents and pending applications, maskwork rights, and copyrights. Altera warrants performance of its semiconductor products to current specifications in accordance with Altera's standard warranty, but reserves the right to make changes to any products and services at any time without notice. Altera assumes no responsibility or liability arising out of the application or use of any information, product, or service described herein except as expressly agreed to in writing by Altera Corporation. Altera customers are advised to obtain the latest version of device specifications before relying on any published information and before placing orders for products or services.



I.S. EN ISO 9001

