



T-41-33

Electro-Optical, Environmental and Mechanical

Absolute Maximum Ratings (Polarizers Attached)

Parameter	Liquid Crystal Material		Unit
	Standard Temperature	"W" Wide Temperature	
Applied Voltage	10	10	V _{RMS}
DC Drive Component Allowable	25	50	mV
Operating Temperature	-20 to +60	-30 to +85	°C
Storage Temperature	-20 to +60	-40 to +85	°C
Operating Frequency	+30 to +100	+30 to +100	Hz

Note:
A. Upper limits achieved with high temperature "U" sheet polarizers (not available with frosted reflector). With standard temperature polarizers, high temperature operation and storage is recommended not to exceed +60°C over extended periods of time.
B. Flicker may occur below 30 Hz; power consumption increases above 100 Hz.

Recommended Operating Conditions (Polarizers Attached)

Parameter	Liquid Crystal Material						Unit
	Standard Temperature			"W" Wide Temperature			
	Min.	Typ.	Max.	Min.	Typ.	Max.	
Operating Voltage	3.0	5.0	6.0	3.5	5.0	6.0	V _{RMS}
Operating Frequency	30	32	35	30	32	100	Hz
Operating Temperature	-10	+25	+60	-30	+25	+85	°C

Typical Operating Characteristics (5 VRMS, 32 Hz, 25°C)

Parameter	Liquid Crystal Material						Unit
	Standard Temperature			"W" Wide Temperature			
	Min.	Typ.	Max.	Min.	Typ.	Max.	
Operating Current							
0.5" Character Height	-	1.0			1.0		µA/ Digit
0.7" Character Height	-	3.0			3.0		µA/ Digit
1.0" Character Height	-	6.0			6.0		µA/ Digit
Optical Response Time							
Rise Time (Ta = 50%°C)	-	15	-		3		mS
Decay Time (Ta = 50%°C)	-	60	-		10		mS
Rise Time (Ta = 25°C)	-	25	-		5		mS
Decay Time (Ta = 25°C)	-	90	-		25		mS
Rise Time (Ta = 0°C)	-	120	-		15		mS
Decay Time (Ta = 0°C)	-	400	-		65		mS
Contrast Ratio	-	20:1	-		18:1		-
Viewing Angle	-	±60°	-		±60°		
DC Resistance	-	100	-		100		MΩ
Expected Life		50000			100000		Hours

All AND LCDs will meet or exceed the above electro/optical, environmental and mechanical specifications.

Environmental Test Specifications

Parameter	Standard Temperature	"W" Wide Temperature
High Temperature Storage RH < 30%	60°C, 500 Hours	60°C, 500 Hours
Low Temperature Storage	-20°C, 500 Hours	-20°C, 500 Hours
Moisture Resistant 80°C, 95%	100 Hours without polarizer 500 Hours 240 Hours	100 Hours without polarizer 500 Hours 500 Hours
60°C, 70% without polarizer 60°C, 70% with polarizer		
High Temperature Operation 10 V _{RMS} , 32 Hz Square Wave	60°C, 500 Hours	80°C, 500 Hours
Temperature Cycling (air to air, 10 cycles)	-20°C, 20 Minutes 60°C, 20 Minutes	20°C, 20 Minutes 85°C, 20 Minutes

Note: High stability "U" Polarizer not available with reflective silver bead backing.

Mechanical Specifications

Parameter	Min.	Typ.	Max.	Unit
Mechanical Shock: Mechanical shock consisting of 300 Gs @ .5 milliseconds in three mutually perpendicular axes. The LCD is fixed in position on its front surface.		1		Cycle
Thermal Shock (without polarizer) 2 minutes @ °C, 2 minutes @ 80°C (in the water) transfer time not to exceed 15 seconds.		5		Cycles
Vibration One Logarithmic frequency sweep from 10 to 2000 Hz (sinusoidal) at 20 Gs, or 1.5 mm amplitude (whichever is smaller) during a 20 minute time period. One sweep is required in each of three mutually perpendicular axes. The LCD is fixed in position on its front surface.		1		Sweep
Connector Pin Bend Test (Exceeds MIL-STD-883): With an 8 ounce weight attached to the pins, the pin must exceed three 90° bends before breaking.		3		Bends
UV Radiation: 1.5 mW/cm ² UV Radiation (3650 black light) 1 all ≤ 200%		240		Hours



Electro-Optical, Environmental and Mechanical

T-41-33

Absolute Maximum Ratings (Polarizers Attached)

Parameter	Standard Temperature	Unit
Applied Voltage	10	V _{rms}
DC Drive Component Allowable	50	mV
Operating Temperature	0 to +60	°C
Storage Temperature	-20 to +60	°C
Frame Frequency	200	Hz

Recommended Operating Conditions

Parameter	Min.	Typ.	Max.	Unit
Operating Voltage	5.0±0.25			V _{rms}
Frame Frequency	100	-	200	Hz
Operating Temperature	0	25	50	C

Typical Operating Characteristics

Parameter	Min.	Typ.	Max.	Unit
Operating Current				
0.5" Character Height	-	4.0	8.0	µA/Cell
Optical Response Time				
Rise Time (Ta=25°C)	-	300	-	ms
Decay Time (Ta=25°C)	-	300	-	ms
Rise Time (Ta=0°C)	-	1000	-	ms
Decay Time (Ta=0°C)	-	1000	-	ms
Contrast Ratio	-	20:1	-	-
Viewing Angle	-	*	-	-
DC Resistance	-	10	-	MΩ
Expected Life	-	50000	-	Hours

Mechanical Specifications

Parameter	Min.	Typ.	Max.	Unit
Mechanical Shock: Mechanical shock consisting of 300 Gs @ .5 milliseconds in three mutually perpendicular axes. The LCD is fixed in position on its front surface.		1		Cycle
Vibration One Logarithmic frequency sweep from 10 to 2000 Hz (sinusoidal) at 20 Gs, or 1.5 mm amplitude (whichever is smaller) during a 20 minute time period. One sweep is required in each of three mutually perpendicular axes. The LCD is fixed in position on its front surface.		1		Sweep
Connector Pin Bend Test (Exceeds MIL-STD-883): With an 8 ounce weight attached to the pins, the pin must exceed three 90° bends before breaking.		3		Bends

Driving Wave Form

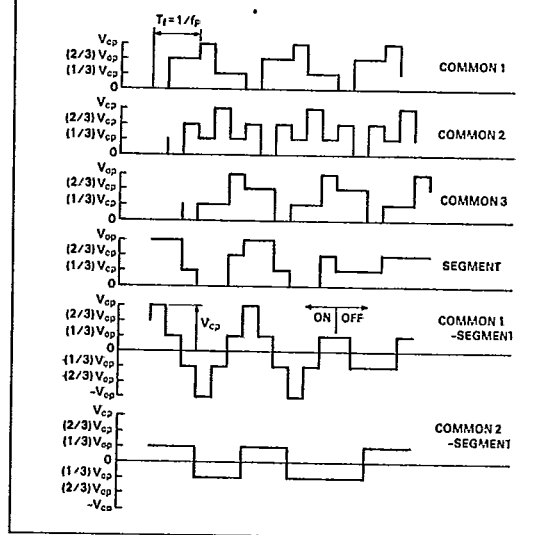

*Viewing Angle

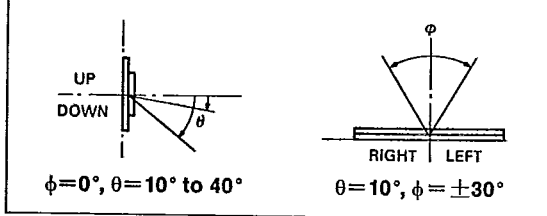

Environmental Test Specifications

Parameter	Min.	Typ.	Max.	Unit
Temperature/Humidity:				
A. No Polarizers				
80°C, 95% Relative Humidity		> 100		Hours
60°C, 70% Relative Humidity		> 500		Hours
B. Polarizers Attached				
60°C, 70% Relative Humidity		> 240		Hours
40°C, 95% Relative Humidity		> 500		Hours
Thermal Shock (No Polarizers):				
Liquid to Liquid				
2 Minutes @ 0°C, 2 minutes @ +80°C and a transfer time from one extreme to the other not to exceed 15 seconds.		5		Cycles
Temperature Cycling (Air to Air):				
Air to Air				
20 minutes @ -20°C to 20 minutes @ +60°C and a transfer time from one extreme to the other not to exceed 10 minutes.		10		Cycles



T-41-33

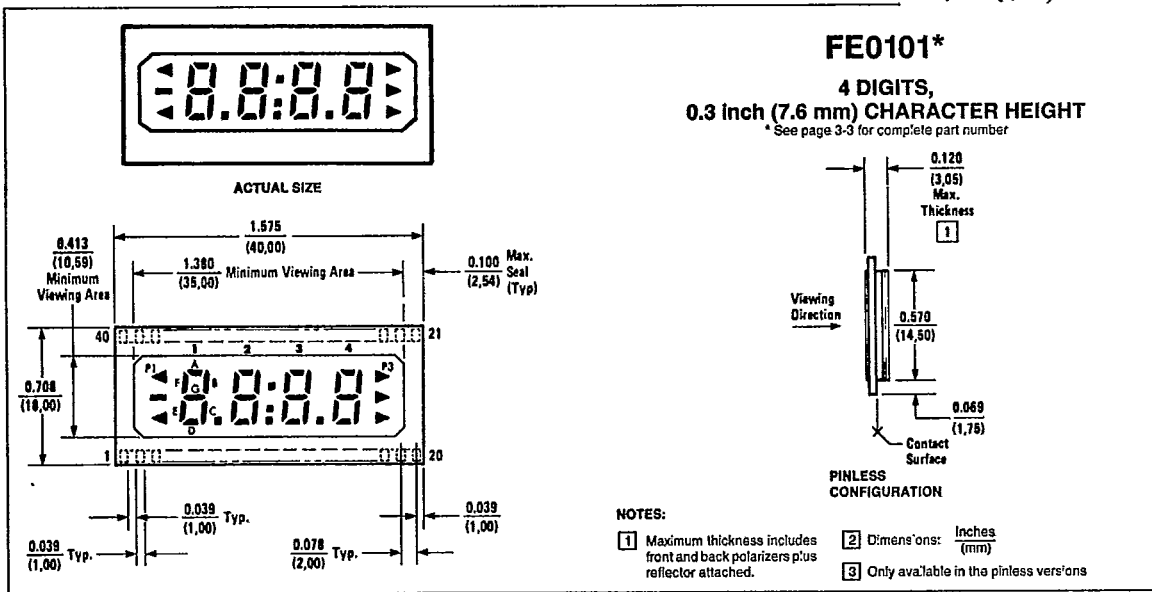

Pin. No.	1	2	3	4	5	6	7	8	9	10	11	12	13	14	15	16	17	18	19	20	21	22	23	24	25	26	27	28	29	30	31	32	33	34	35	36	37	38	39	40
Segment	BP	-	P2	E1	D1	G1	dp	E2	D2	C2	dp	E3	D3	C3	dp	E4	D4	C4	F5	P4	P3	B4	A4	F4	G4	B3	A3	F3	G3	COL	B2	A2	F2	G2	B1	A1	F1	G1	P1	BP

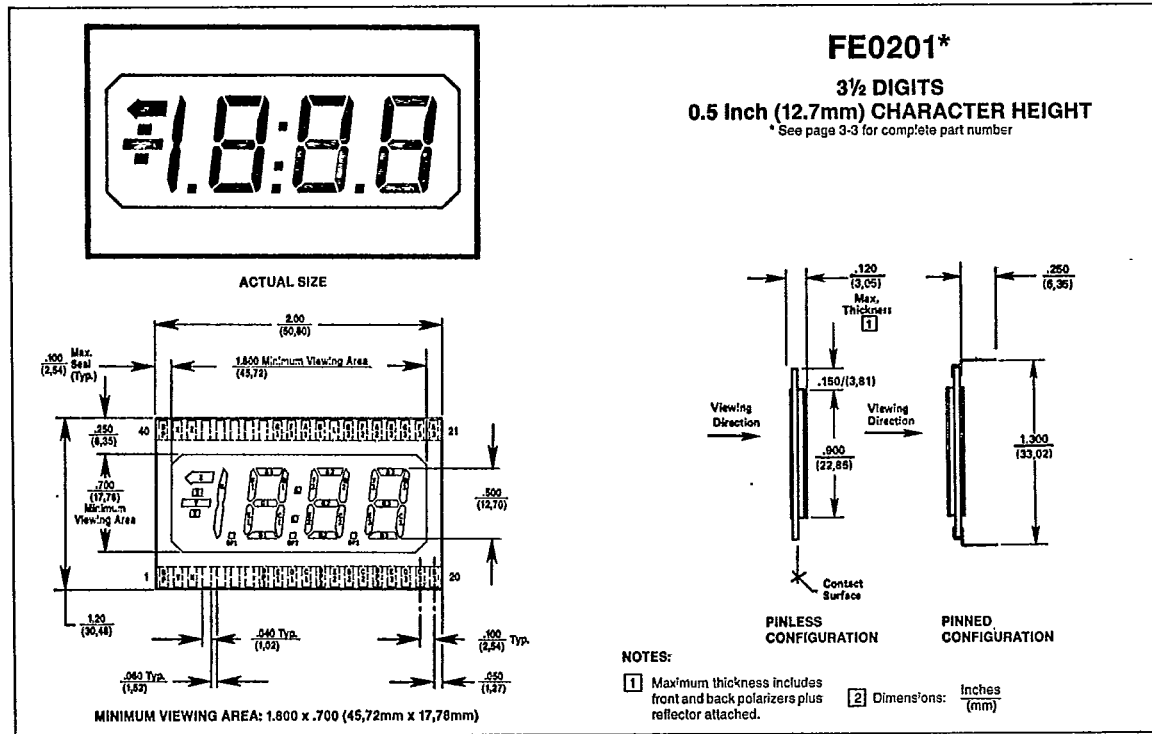

Pin. No.	1	2	3	4	5	6	7	8	9	10	11	12	13	14	15	16	17	18	19	20	21	22	23	24	25	26	27	28	29	30	31	32	33	34	35	36	37	38	39	40
Segment	BP	Y	K	N/C	N/C	N/C	N/C	dp1	E1	D1	C1	dp2	E2	D2	C2	dp3	E3	D3	C3	B3	A3	F3	G3	B2	A2	F2	G2	L	B1	A1	F1	G1	N/C	N/C	N/C	N/C	N/C	Z	X	BP



T-41-33



FE0202*
4 DIGITS,
0.5 Inch (12.7 mm) CHARACTER HEIGHT
* See page 3-3 for complete part number

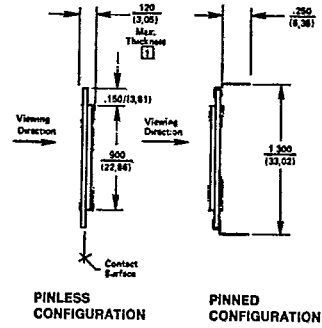
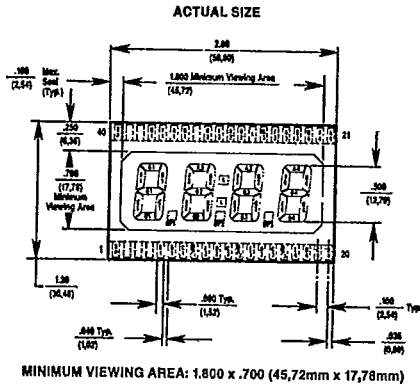

NOTES:
 1 Maximum thickness includes front and back polarizers plus reflector attached.
 2 Dimensions: $\frac{\text{Inches}}{\text{(mm)}}$

Pin. No.	1	2	3	4	5	6	7	8	9	10	11	12	13	14	15	16	17	18	19	20	21	22	23	24	25	26	27	28	29	30	31	32	33	34	35	36	37	38	39	40
Segment	BP	N/C	N/C	N/C	E1	D1	C1	dp1	E2	D2	C2	dp3	E3	D3	C3	dp3	E4	D4	C4	B4	A4	F4	G4	B3	A3	F3	G3	L	B2	A2	F2	G2	N/C	B1	A1	F1	G1	N/C	N/C	BP

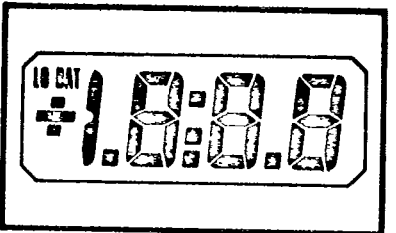

FE0203*
3½ DIGITS
0.5 Inch (12.7mm) CHARACTER HEIGHT
* See page 3-3 for complete part number

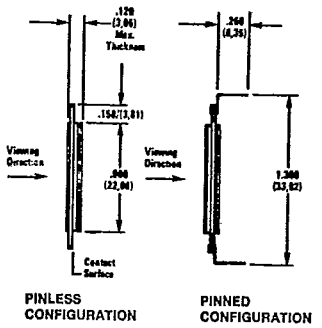
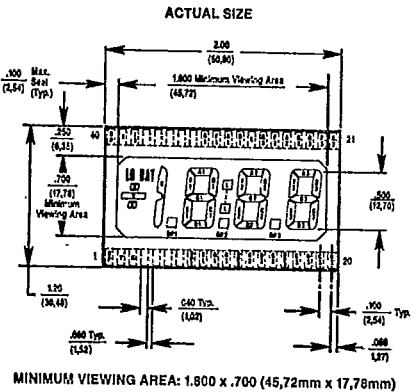

NOTES:
 1 Maximum thickness includes front and back polarizers plus reflector attached.
 2 Dimensions: $\frac{\text{Inches}}{\text{(mm)}}$

Pin. No.	1	2	3	4	5	6	7	8	9	10	11	12	13	14	15	16	17	18	19	20	21	22	23	24	25	26	27	28	29	30	31	32	33	34	35	36	37	38	39	40	
Segment	BP	Y	K	N/C	N/C	N/C	N/C	dp1	E1	D1	C1	dp2	E2	D2	C2	dp3	E3	D3	C3	B3	A3	F3	G3	B2	A2	F2	G2	L	B1	A1	F1	G1	N/C	N/C	N/C	N/C	N/C	N/C	LO	X	BP



T-41-33

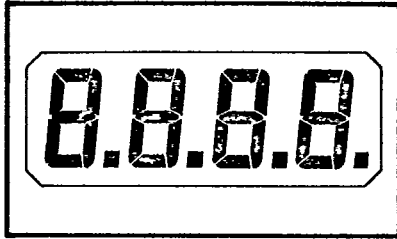

ACTUAL SIZE

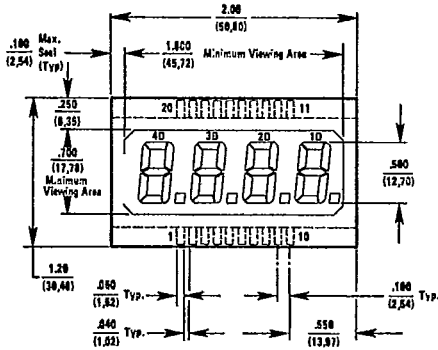

FE0204M*
4 DIGITS,
0.5 Inch (12.7 mm) CHARACTER HEIGHT

* See page 3-3 for complete part number

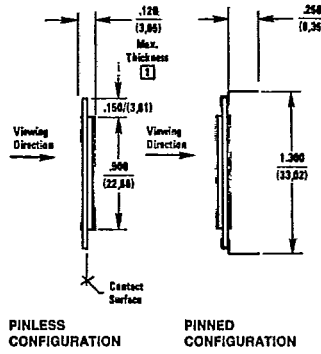

NOTES:

[1] Maximum thickness includes front and back polarizers plus reflector attached.

[2] Dimensions: $\frac{\text{Inches}}{\text{(mm)}}$

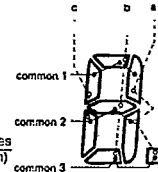

Pin. No.	1	2	3	4	5	6	7	8	9	10	11	12	13	14	15	16	17	18	19	20
Segment	NC	NC	NC	4D-a	3D-a	2D-a	1D-a	BP3	NC	NC	BP1	1D-b	1D-c	2D-b	2D-c	3D-b	3D-c	4D-b	4D-c	BP2

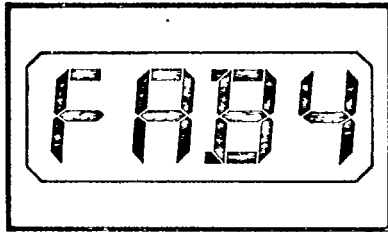

ACTUAL SIZE

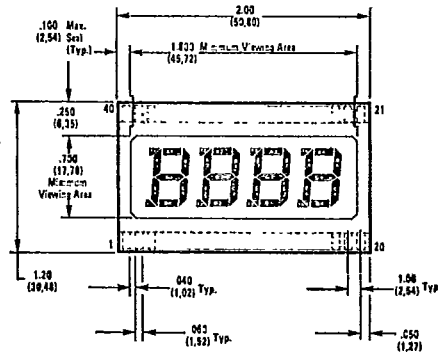

FE0205*
4 FULL HEXADECIMAL CHARACTERS
0.5 Inch (12.7mm) CHARACTER HEIGHT

* See page 3-3 for complete part number

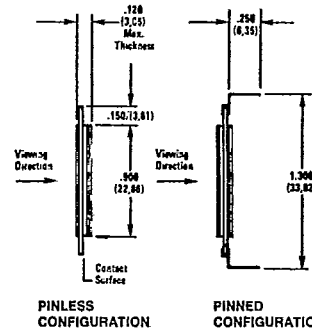

NOTES:

[1] Maximum thickness includes front and back polarizers plus reflector attached.

[2] Dimensions: $\frac{\text{Inches}}{\text{(mm)}}$

Pin. No.	1	2	3	4	5	6	7	8	9	10	11	12	13	14	15	16	17	18	19	20	21	22	23	24	25	26	27	28	29	30	31	32	33	34	35	36	37	38	39	40
Segment	BP	T1	E1	D1	C1	T2	E2	D2	C2	N/C	T3	E3	D3	C3	T4	E4	D4	C4	N/C	N/C	N/C	G4	B4	A4	F4	G3	B3	A3	F3	N/C	G2	B2	A2	F2	G1	B1	A1	F1	N/C	BP



LCD Panel Displays

FE0206/FE0208

T-41-33

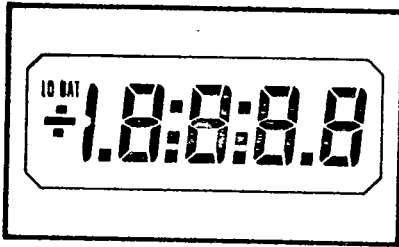

ACTUAL SIZE

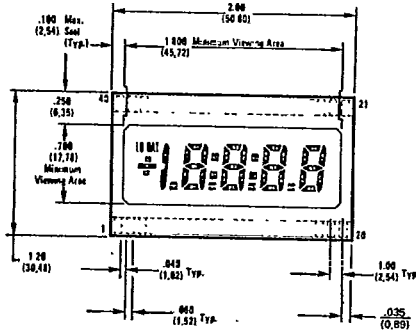

FE0206*
4½ DIGITS,
0.4 inch (10.2 mm) CHARACTER HEIGHT

* See page 3-3 for complete part number

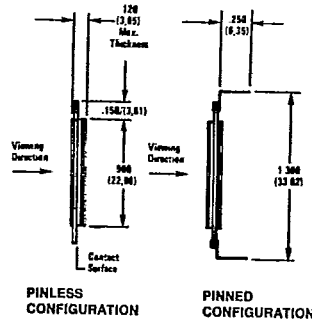

NOTES:

- 1 Maximum thickness includes front and back polarizers plus reflector attached.
- 2 Dimensions: Inches (mm)

Pin. No.	1	2	3	4	5	6	7	8	9	10	11	12	13	14	15	16	17	18	19	20	21	22	23	24	25	26	27	28	29	30	31	32	33	34	35	36	37	38	39	40
Segment	BP	Y	K	DP1	E1	D1	C1	DP2	E2	D2	C2	DP3	E3	D3	C3	DP4	E4	D4	C4	B4	A4	F4	G4	B3	A3	F3	G3	L2	B2	A2	F2	G2	L1	B1	A1	F1	G1	BAT	X	BP

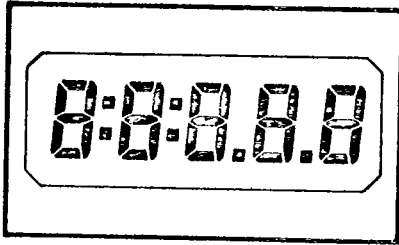

ACTUAL SIZE

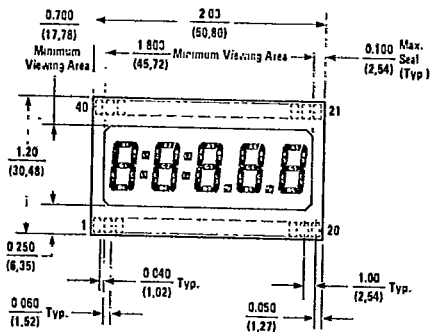

FE0208*
5 DIGITS
0.4 Inch (10.2mm) CHARACTER HEIGHT

* See page 3-3 for complete part number

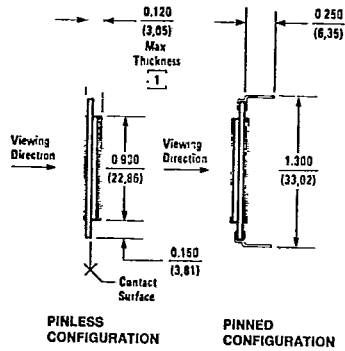

NOTES:

- 1 Maximum thickness includes front and back polarizers plus reflector attached.
- 2 Dimensions: Inches (mm)

Pin. No.	1	2	3	4	5	6	7	8	9	10	11	12	13	14	15	16	17	18	19	20	21	22	23	24	25	26	27	28	29	30	31	32	33	34	35	36	37	38	39	40
Segment	BP	G1	E1	D1	C1	E2	D2	C2	E3	D3	C3	DP1	E4	D4	C4	DP2	E5	D5	C5	B5	A5	F5	G5	B4	A4	F4	G4	B3	A3	F3	G3	L2	B2	A2	F2	G2	L1	B1	A1	F1



LCD Panel Displays

FE0401/FE0405

T-41-33

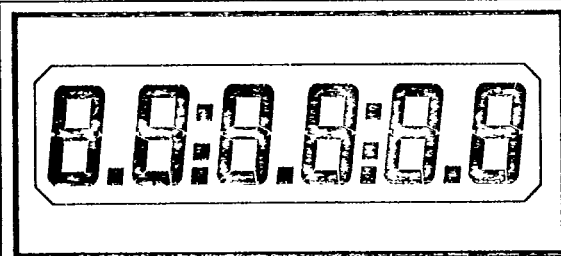

FE0401*

6 DIGITS,
0.5 inch (12.7 mm) CHARACTER HEIGHT

* See page 3-3 for complete part number

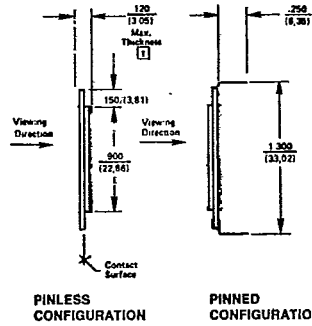
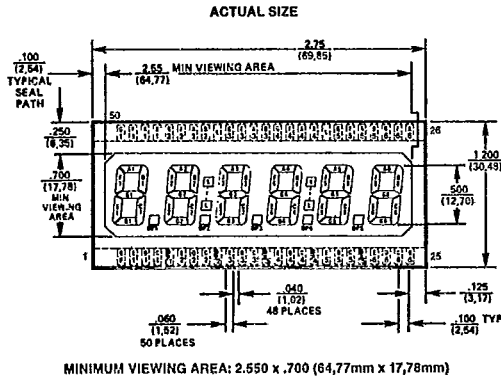

NOTES:

- [1] Maximum thickness includes front and back polarizers plus reflector attached.
- [2] Dimensions: Inches (mm)

Pin. No.	1	2	3	4	5	6	7	8	9	10	11	12	13	14	15	16	17	18	19	20	21	22	23	24	25	26	27	28	29	30	31	32	33	34	35	36	37	38	39	40
Segment	BP	E1	D1	C1	dp1	E2	D2	C2	dp2	E3	D3	C3	dp3	E4	D4	C4	dp4	E5	D5	C5	dp5	E6	D6	C6	B6	A6	F6	G6	B5	A5	F5	G5	L	B4	A4	F4	G4	B3	A3	F3

Pin. No.	41	42	43	44	45	46	47	48	49	50
Segment	G3	L	B2	A2	F2	G2	B1	A1	F1	G1

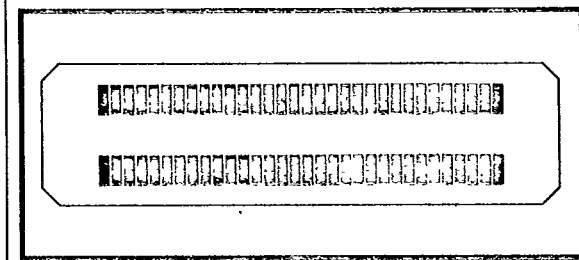

FE0405*

64 POSITION BAR GRAPH
(2 ROWS OF 32 POSITIONS)

* See page 3-3 for complete part number

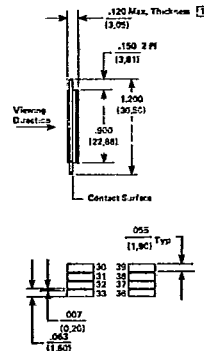
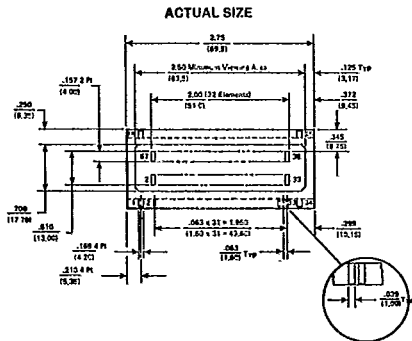

NOTES:

- [1] Maximum thickness includes front and back polarizers plus reflector attached.
- [2] Dimensions: Inches (mm)
- [3] Pads 1, 34, 35 and 68 are backplane connections. All four are internally tied together. One or all may be used if it is recommended to use at least two.
- [4] Display orientation is not critical (no specific left or right side).
- [5] Only available in pinless versions.



LCD Panel Displays

FE0501/FE0502

T-41-33

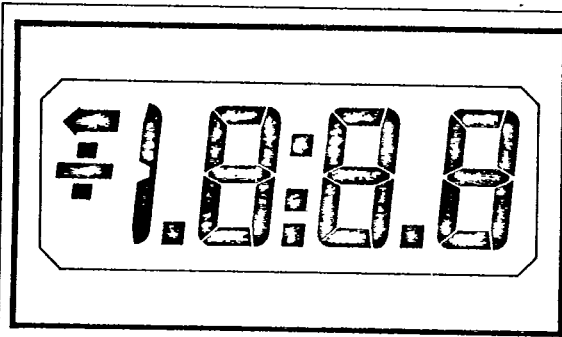

ACTUAL SIZE

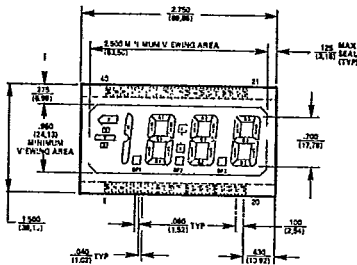

MINIMUM VIEWING AREA: 2.500" x .950" (63.50 mm x 24.13 mm)

FE0501*

3 1/2 DIGITS,
0.7 inch (17.8 mm) CHARACTER HEIGHT

* See page 3-3 for complete part number

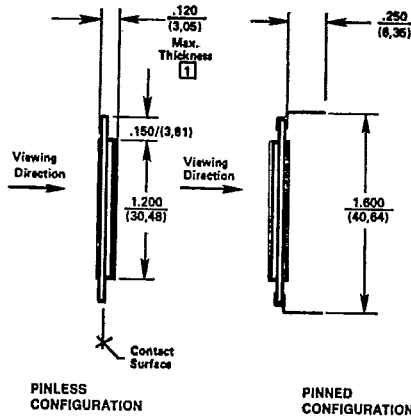

NOTES:

1 Maximum thickness includes front and back polarizers plus reflector attached.

2 Dimensions: Inches (mm)

Pin. No.	1	2	3	4	5	6	7	8	9	10	11	12	13	14	15	16	17	18	19	20	21	22	23	24	25	26	27	28	29	30	31	32	33	34	35	36	37	38	39	40
Segment	BP	Y	K	N/C	N/C	N/C	N/C	dp1	E1	D1	C1	dp2	E2	D2	C2	dp3	E3	D3	C3	B3	A3	F3	G3	B2	A2	F2	G2	L	B1	A1	F1	G1	N/C	N/C	N/C	N/C	N/C	Z	X	BP

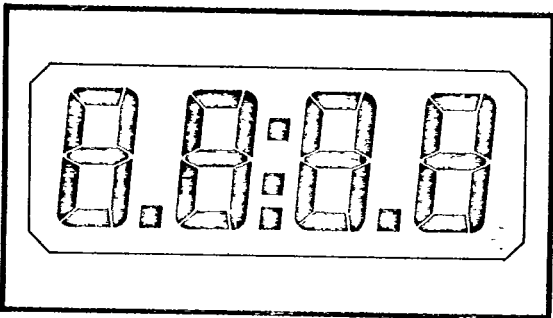

ACTUAL SIZE

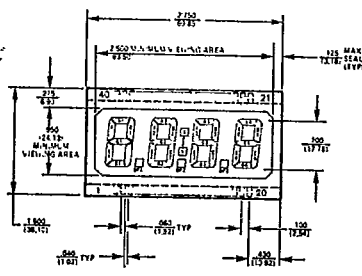

FE0502*

4 DIGITS,
0.7 inch (17.8 mm) CHARACTER HEIGHT

* See page 3-3 for complete part number

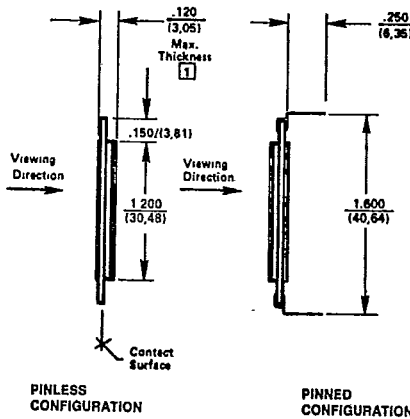

NOTES:

1 Maximum thickness includes front and back polarizers plus reflector attached.

2 Dimensions: Inches (mm)

Pin. No.	1	2	3	4	5	6	7	8	9	10	11	12	13	14	15	16	17	18	19	20	21	22	23	24	25	26	27	28	29	30	31	32	33	34	35	36	37	38	39	40	
Segment	BP	N/C	N/C	N/C	N/C	E1	D1	C1	dp1	E2	D2	C2	dp2	E3	D3	C3	dp3	E4	D4	C4	B4	A4	F4	G4	B3	A3	F3	G3	L	B2	A2	F2	G2	N/C	B1	A1	F1	G1	N/C	N/C	BP



LCD Panel Displays

FE0601/FE0701

T-41-33

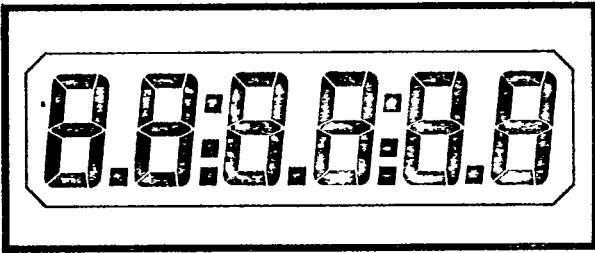

ACTUAL SIZE

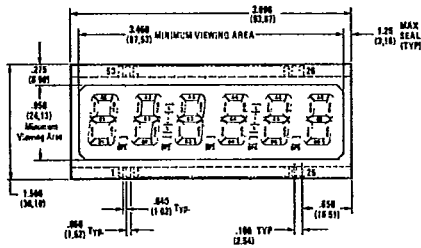

FE0601*

6 DIGITS,
0.7 inch (17.8 mm) CHARACTER HEIGHT

* See page 3-3 for complete part number

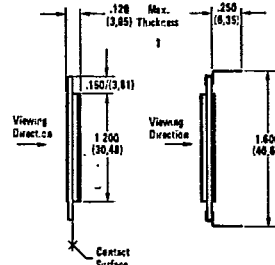

PINLESS CONFIGURATION

PINNED CONFIGURATION

NOTES:

- 1 Maximum thickness includes front and back polarizers plus reflector attached.
- 2 Dimensions: Inches (mm)

Pin. No.	1	2	3	4	5	6	7	8	9	10	11	12	13	14	15	16	17	18	19	20	21	22	23	24	25	26	27	28	29	30	31	32	33	34	35	36	37	38	39	40
Segment	BP	E1	D1	C1	dp1	E2	D2	C2	dp2	E3	D3	C3	dp3	E4	D4	C4	dp4	E5	D5	C5	dp5	E6	D6	C6	B6	A6	F6	G6	B5	A5	F5	G5	L	B4	A4	F4	G4	B3	A3	F3

Pin. No.	41	42	43	44	45	46	47	48	49	50
Segment	G3	L	B2	A2	F2	G2	B1	A1	F1	G1

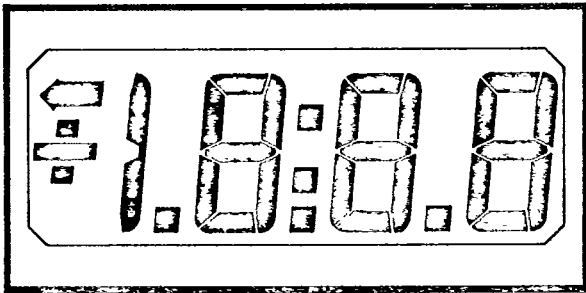

ACTUAL SIZE

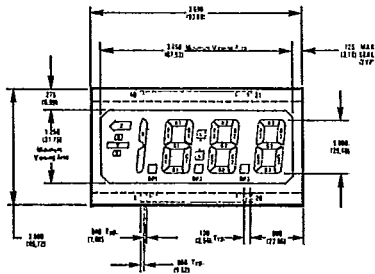

FE0701*

3 1/2 DIGITS,
1.0 inch (25.4 mm) CHARACTER HEIGHT

* See page 3-3 for complete part number

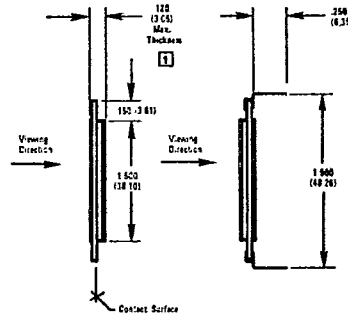

PINNED CONFIGURATION

PINLESS CONFIGURATION

NOTES:

- 1 Maximum thickness includes front and back polarizers plus reflector attached.
- 2 Dimensions: Inches (mm)

Pin. No.	1	2	3	4	5	6	7	8	9	10	11	12	13	14	15	16	17	18	19	20	21	22	23	24	25	26	27	28	29	30	31	32	33	34	35	36	37	38	39	40	
Segment	BP	Y	K	N/C	N/C	N/C	N/C	dp1	E1	D1	C1	dp2	E2	D2	C2	dp3	E3	D3	C3	B3	A3	F3	G3	B2	A2	F2	G2	L	B1	A1	F1	G1	N/C	N/C	N/C	N/C	N/C	N/C	Z	Y	BP

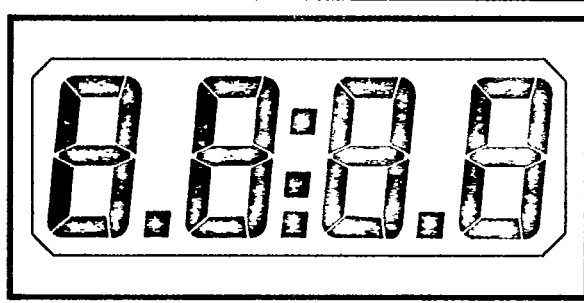

ACTUAL SIZE

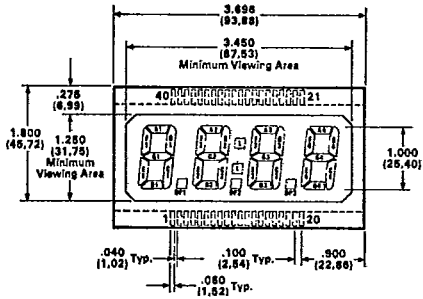

FE0703*

**4 DIGITS,
1.0 inch (25.4 mm) CHARACTER HEIGHT**

* See page 3-3 for complete part number

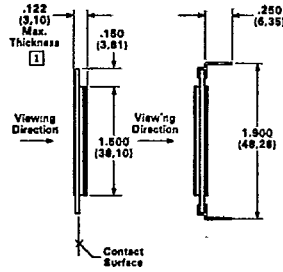

PINLESS CONFIGURATION

PINNED CONFIGURATION

NOTES:

- 1 Glass thickness (non-accumulative) is .043 (1.1) ± .006 (.15)
Total thickness of bare cell (front and rear glass) is .087 (2.2) ± .008 (.2)
- 2 Dimensions: Inches (mm)

Pin. No.	1	2	3	4	5	6	7	8	9	10	11	12	13	14	15	16	17	18	19	20	21	22	23	24	25	26	27	28	29	30	31	32	33	34	35	36	37	38	39	40
Segment	BP	N/C	N/C	N/C	E1	D1	C1	dp1	E2	D2	C2	dp2	E3	D3	C3	dp3	E4	D4	C4	B4	A4	F4	G4	B3	A3	F3	G3	L	B2	A2	F2	G2	N/C	B1	A1	F1	G1	N/C	N/C	BP

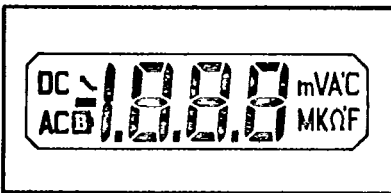

ACTUAL SIZE

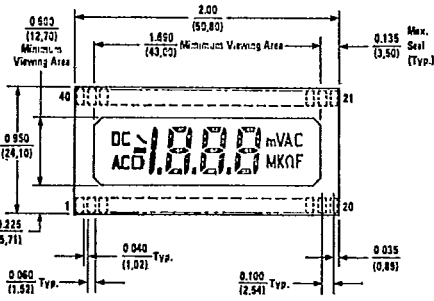

FE0801*

**3 1/2 DIGITS,
0.4 inch (10.2 mm) CHARACTER HEIGHT**

* See page 3-3 for complete part number

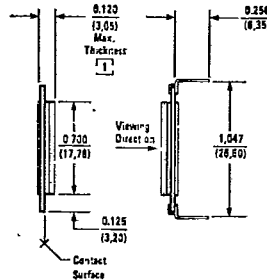

PINLESS CONFIGURATION

PINNED CONFIGURATION

NOTES:

- 1 Maximum thickness includes front and back polarizers plus reflector attached.
- 2 Dimensions: Inches (mm)

Pin. No.	1	2	3	4	5	6	7	8	9	10	11	12	13	14	15	16	17	18	19	20	21	22	23	24	25	26	27	28	29	30	31	32	33	34	35	36	37	38	39	40		
Segment	BP	N/C	AC	BAT	K	dp	E1	D1	C1	dp	E2	D2	C2	dp	E3	D3	C3	M	K	Ω	°	F	°	C	A	V	m	B3	A3	F3	G3	B2	A2	F2	G2	B1	A1	F1	G1	OV	-	DC



T-41-33

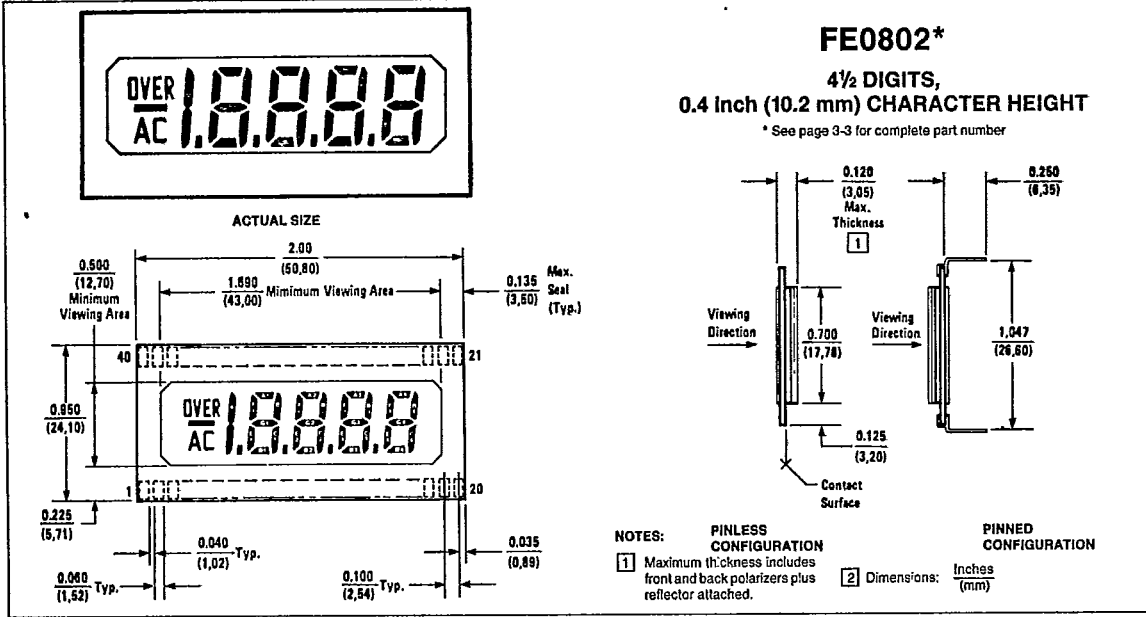

Pin. No.	1	2	3	4	5	6	7	8	9	10	11	12	13	14	15	16	17	18	19	20	21	22	23	24	25	26	27	28	29	30	31	32	33	34	35	36	37	38	39	40			
Segment	BP	N/C	AC	K	dp	E1	D1	C1	dp	E2	D2	C2	dp	E3	D3	C3	dp	E4	D4	C4	dp	E5	D5	C5	dp	E6	D6	C6	B6	A6	F6	G6	B5	A5	F5	G5	L2	B4	A4	F4	G4	B3	A3

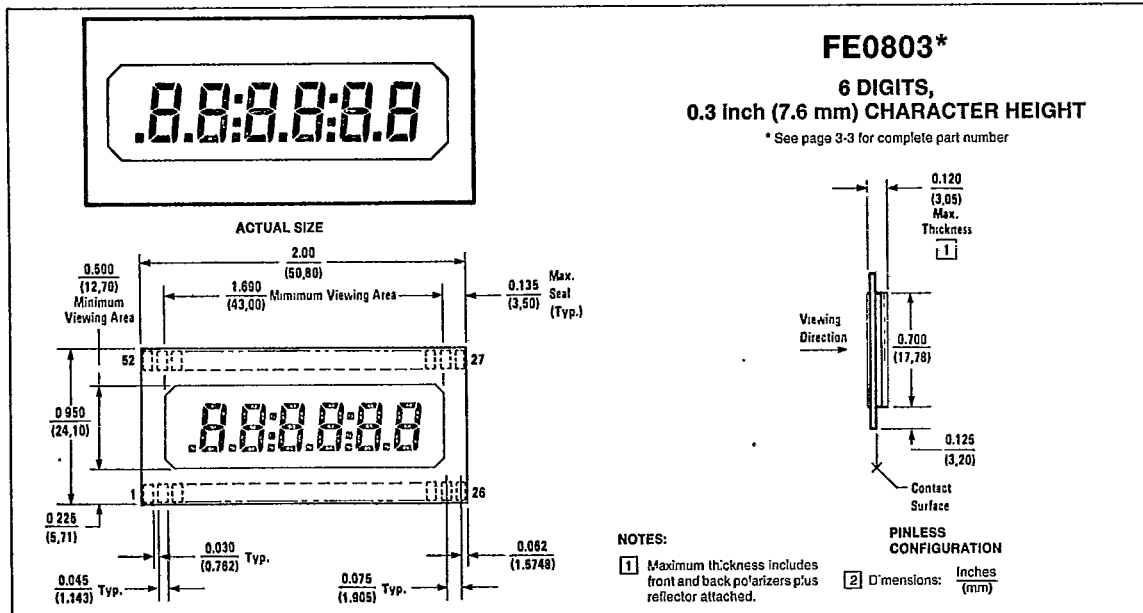

Pin. No.	1	2	3	4	5	6	7	8	9	10	11	12	13	14	15	16	17	18	19	20	21	22	23	24	25	26	27	28	29	30	31	32	33	34	35	36	37	38	39	40
Segment	BP	dp	E1	D1	C1	dp	E2	D2	C2	dp	E3	D3	C3	dp	E4	D4	C4	dp	E5	D5	C5	dp	E6	D6	C6	B6	A6	F6	G6	B5	A5	F5	G5	L2	B4	A4	F4	G4	B3	A3

Pin. No.	41	42	43	44	45	46	47	48	49	50	51	52
Segment	F3	G3	L1	B2	A2	F2	G2	B1	A1	F1	G1	BP



LCD Panel Displays

FE0804/FE1001

T-41-33

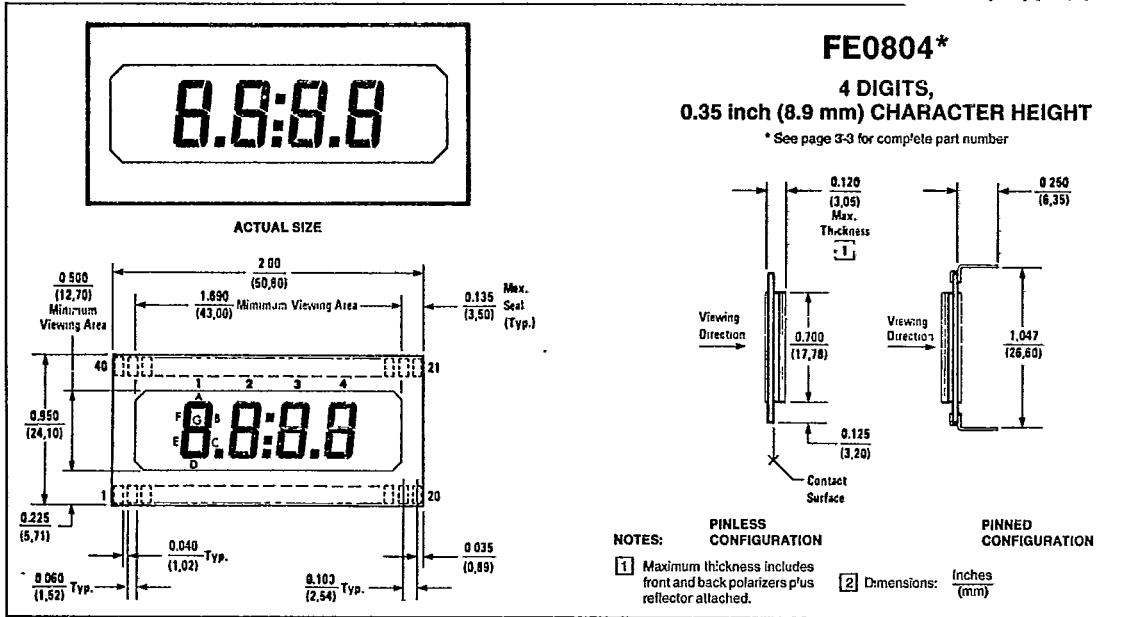

Pin. No.	1	2	3	4	5	6	7	8	9	10	11	12	13	14	15	16	17	18	19	20	21	22	23	24	25	26	27	28	29	30	31	32	33	34	35	36	37	38	39	40
Segment	BP	N/C	N/C	N/C	E1	D1	C1	DP1	E2	D2	C2	DP2	E3	D3	C3	DP3	E4	D4	C4	B4	A4	F4	G4	B3	A3	F3	G3	COL	B2	A2	F2	G2	N/C	B1	A1	F1	G1	N/C	N/C	BP

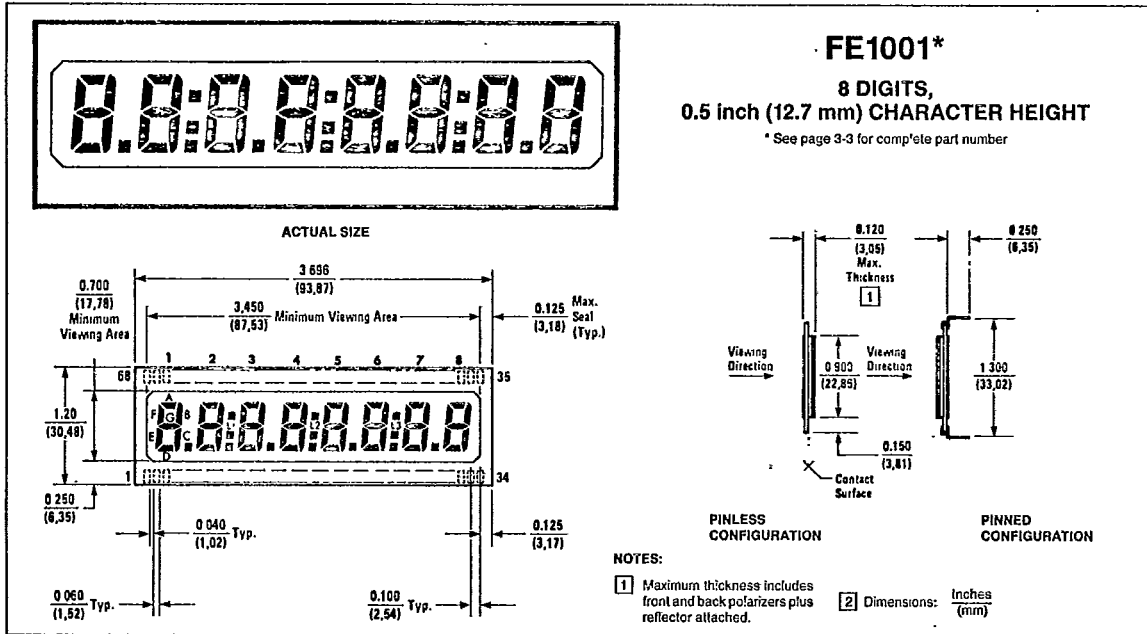

Pin. No.	1	2	3	4	5	6	7	8	9	10	11	12	13	14	15	16	17	18	19	20	21	22	23	24	25	26	27	28	29	30	31	32	33	34	35	36	37	38	39	40
Segment	BP	E1	D1	C1	dp	E2	D2	C2	dp	BP	E3	D3	C3	dp	E4	D4	C4	dp	E5	D5	C5	dp	E6	D6	C6	dp	E7	D7	C7	dp	E8	D8	C8	B8	A8	F8	G8	B7	A7	F7

Pin. No.	41	42	43	44	45	46	47	48	49	50	51	52	53	54	55	56	57	58	59	60	61	62	63	64	65	66	67	68
Segment	G7	I3	B6	A6	F6	G6	B5	A5	F5	G5	L2	B4	A4	F4	G4	B3	A3	F3	G3	L1	B2	A2	F2	G2	B1	A1	F1	G1



T-41-33

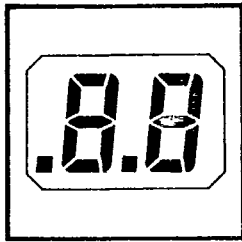

FE1901*

**2 DIGITS,
0.5 inch (12.7 mm) CHARACTER HEIGHT**

* See page 3-3 for complete part number

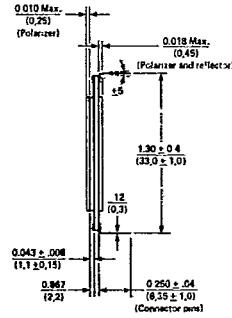
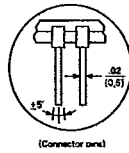
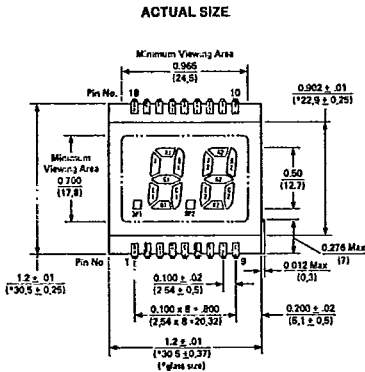

Display Orientation: Locate silver dots in the display seal (black border). These indicate left side of display when display is in the viewing position.

Dimensions: Inches (mm)

MINIMUM VIEWING AREA: 1.00 X .700 (25.40 X 17.78)

Pin No. 1 2 3 4 5 6 7 8 9 10 11 12 13 14 15 16 17 18

Segment BP DP1 E1 D1 C1 DP2 E2 D2 C2 B2 A2 F2 G2 B1 A1 F1 G1 BP

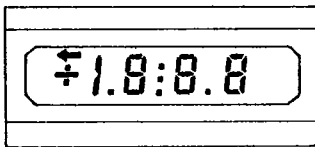

FE2201*

**3½ DIGITS,
0.2 inch (5.1 mm) CHARACTER HEIGHT**

* See page 3-3 for complete part number

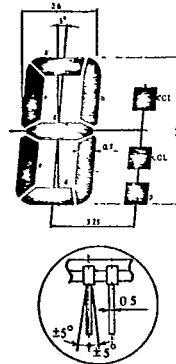
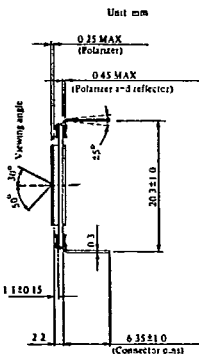
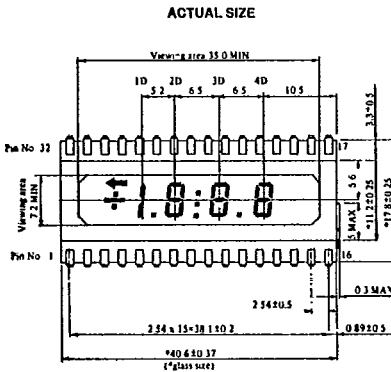

Pin No. 1 2 3 4 5 6 7 8 9 10 11 12 13 14 15 16 17 18 19 20 21 22 23 24 25 26 27 28 29 30 31 32

Segment bp - 1bc 1p 2e 2d 2c 2p 3e 3d 3c 3p 4a 4d 4c 4b 4a 4f 4g 3b 3a 3f 3g COL 2b 2a 2f 2g NC ARW : bp