

SPECIFICATIONS
 Current Rating : 1 AMP
 Dielectric Withstanding Voltage :
 AC 500V For 1 Minute
 Contact Resistance : 30 Milliohms Max.
 At DC 100mA
 Insulator Resistance : 1000Megohms Min.
 At DC 500V
 Operating Temperature : -55°C To +105°C
 Single Contact Insertion Force : 500g Max.
 Single Contact Withdrawal Force : 30g Min.
 Contact : Phosphor Bronze, Tin Plated
 Housing : PBT &30% Glass Fiber UL 94V-0

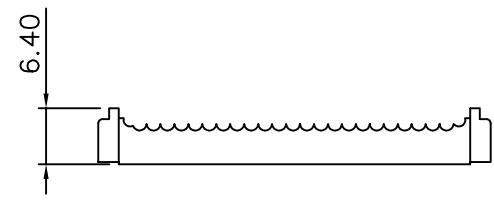

Middle Cover

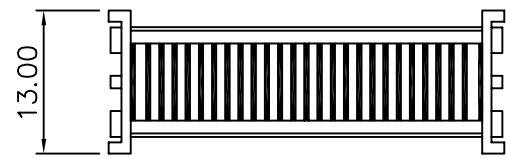
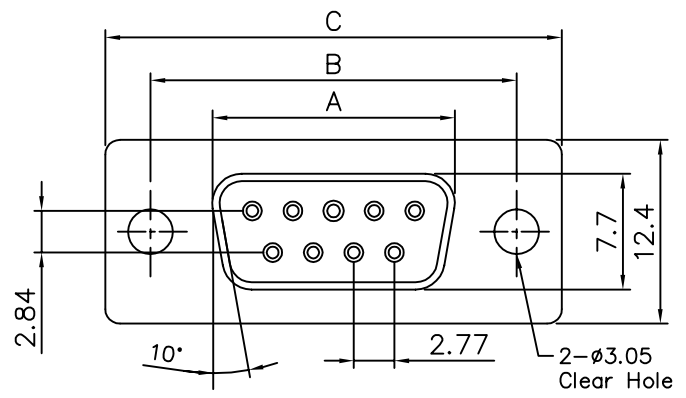
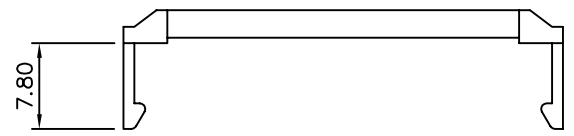
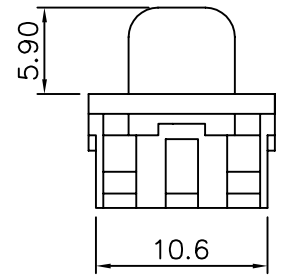
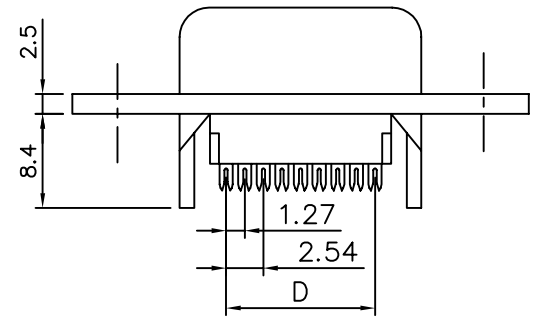
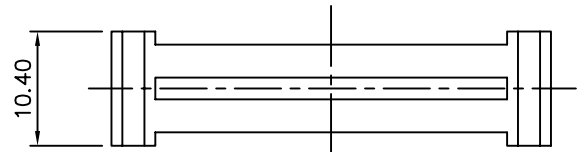

Strain Relief

Circuits	A	B	C	D
09	16.00	24.99	30.50	10.16
15	24.27	33.32	39.00	17.78
25	38.22	47.04	53.08	30.48
37	54.65	63.50	69.25	45.72

AUK A NUMBER OF AUK GROUP
 太聯事業股份有限公司
 AUK CONTRACTORS CO., LTD.

DRAWING No. DFP15S

APPROVED BY MEI
 CHECKED BY RAN
 DRAWING BY HZF

UNLESS OTHERWISE SPECIFIED TOLERANCES ARE
 .X ±0.38
 .XX ±0.25
 .XXX

SCALE NONE REV. A UNIT mm

AREA REVISIONS CHK DATE