



## 128K × 16 HIGH-SPEED CMOS STATIC RAM

### GENERAL DESCRIPTION

The W26020A is a high-speed, low-power CMOS static RAM organized as 131,072 × 16 bits that operates on a single 5-volt power supply. This device is manufactured using Winbond's high performance CMOS technology.

The W26020A has an active low chip select, separate upper and lower byte selects, and a fast output enable. No clock or refreshing is required. Separate byte select controls ( $\overline{\text{LB}}$  and  $\overline{\text{UB}}$ ) allow individual bytes to be written and read.  $\overline{\text{LB}}$  controls I/O1-I/O8, the lower byte.  $\overline{\text{UB}}$  controls I/O9-I/O16, the upper byte. This device is well suited for use in high-density, high-speed system applications.

### FEATURES

- High speed access time: 20/25 nS (max.)
- Low power consumption:
  - Active: 1.5W (max.)
- Single +5V power supply
- Fully static operation
  - No clock or refreshing
- All inputs and outputs directly TTL compatible
- Three-state outputs
- Data byte control
  - $\overline{\text{LB}}$  (I/O1-I/O8),  $\overline{\text{UB}}$  (I/O9-I/O16)
- Available packages: 44-pin type two TSOP

### PIN CONFIGURATION

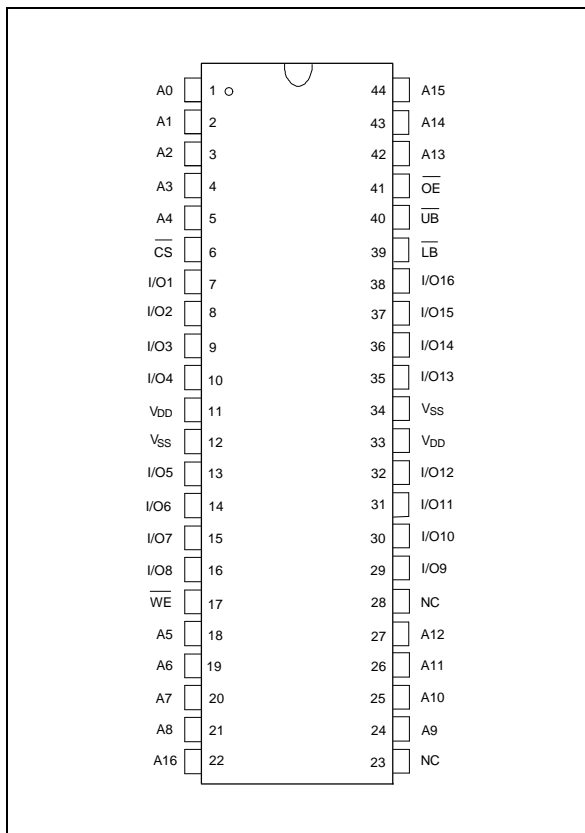

### BLOCK DIAGRAM

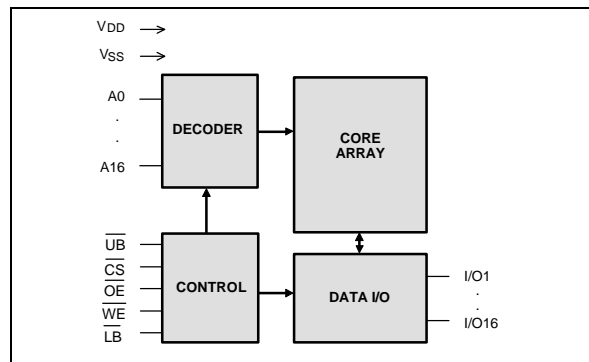

### PIN DESCRIPTION

SYMBOL	DESCRIPTION
A0-A16	Address Inputs
I/O1-I/O16	Data Inputs/Outputs
$\overline{\text{CS}}$	Chip Select Inputs
$\overline{\text{WE}}$	Write Enable Input
$\overline{\text{OE}}$	Output Enable Input
$\overline{\text{LB}}$	Lower Byte Select I/O1-I/O8
$\overline{\text{UB}}$	Upper Byte Select I/O9-I/O16
VDD	Power Supply
VSS	Ground
NC	No Connection

## TRUTH TABLE

CS	OE	WE	LB	UB	MODE	I/O1 - I/O8	I/O9 - I/O16	V <sub>DD</sub> CURRENT
H	X	X	X	X	Not Selected	High Z	High Z	ISB, ISB1
L	H	H	X	X	Output Disable	High Z	High Z	I <sub>DD</sub>
L	L	H	L	L	2 Bytes Read	DOUT	DOUT	I <sub>DD</sub>
L	L	H	L	H	Lower Byte Read	DOUT	High Z	I <sub>DD</sub>
L	L	H	H	L	Upper Byte Read	High Z	DOUT	I <sub>DD</sub>
L	X	L	L	L	2 Bytes Write	DIN	DIN	I <sub>DD</sub>
L	X	L	L	H	Lower Byte Write	DIN	High Z	I <sub>DD</sub>
L	X	L	H	L	Upper Byte Write	High Z	DIN	I <sub>DD</sub>
L	X	X	H	H	Output Disable	High Z	High Z	I <sub>DD</sub>

## DC CHARACTERISTICS

### Absolute Maximum Ratings

PARAMETER	RATING	UNIT
Supply Voltage to V <sub>SS</sub> Potential	-0.5 to +7.0	V
Input/Output to V <sub>SS</sub> Potential	-0.5 to V <sub>DD</sub> +0.5	V
Allowable Power Dissipation	1.5	W
Storage Temperature	-65 to +150	°C
Operating Temperature	0 to +70	°C

Note: Exposure to conditions beyond those listed under Absolute Maximum Ratings may adversely affect the life and reliability of the device.

### Operating Characteristics

(V<sub>DD</sub> = 5V ±10%, V<sub>SS</sub> = 0V, T<sub>A</sub> = 0 to 70° C)

PARAMETER	SYM.	TEST CONDITIONS	MIN.	TYP.	MAX.	UNIT
Input Low Voltage	V <sub>IL</sub>	-	-0.5	-	+0.8	V
Input High Voltage	V <sub>IH</sub>	-	+2.2	-	V <sub>DD</sub> +0.5	V
Input Leakage Current	I <sub>LI</sub>	V <sub>IN</sub> = V <sub>SS</sub> to V <sub>DD</sub>	-10	-	+10	μA
Output Leakage Current	I <sub>LO</sub>	V <sub>I/O</sub> = V <sub>SS</sub> to V <sub>DD</sub> Output Pins in High Z, See Truth Table	-10	-	+10	μA
Output Low Voltage	V <sub>OL</sub>	I <sub>OL</sub> = +8.0 mA	-	-	0.4	V
Output High Voltage	V <sub>OH</sub>	I <sub>OH</sub> = -4.0 mA	2.4	-	-	V



Operating Characteristics, continued

PARAMETER	SYM.	TEST CONDITIONS	MIN.	TYP.	MAX.	UNIT	
Operating Power	IDD	$\overline{CS} = V_{IL} \text{ (max.)}$ ,	20	-	-	220	mA
Supply Current		I/O = Open, Cycle = min. Duty = 100%	25	-	-	200	
Standby Power	ISB	$\overline{CS} = V_{IH} \text{ (min.)}$ , Cycle = min.	-	-	50	mA	
Supply Current	ISB1	$\overline{CS} = V_{DD} - 0.2V$ , I/O = open All other pins = $V_{DD} - 0.2V/GND$	-	-	10	mA	

Note: Typical characteristics are evaluated at  $V_{DD} = 5V$ ,  $T_A = 25^\circ C$ .

## CAPACITANCE

( $V_{DD} = 5V$ ,  $T_A = 25^\circ C$ ,  $f = 1\text{ MHz}$ )

PARAMETER	SYM.	CONDITIONS	MAX.	UNIT
Input Capacitance	CIN	$V_{IN} = 0V$	6	pF
Input/Output Capacitance	C <sub>I/O</sub>	$V_{OUT} = 0V$	8	pF

Note: These parameters are sampled but not 100% tested.

## AC CHARACTERISTICS

### AC Test Conditions

PARAMETER	CONDITIONS
Input Pulse Levels	0V to 3V
Input Rise and Fall Times	3 nS
Input and Output Timing Reference Level	1.5V
Output Load	$C_L = 30\text{ pF}$ , $I_{OH}/I_{OL} = -4\text{ mA}/8\text{ mA}$

## AC Test Loads and Waveform

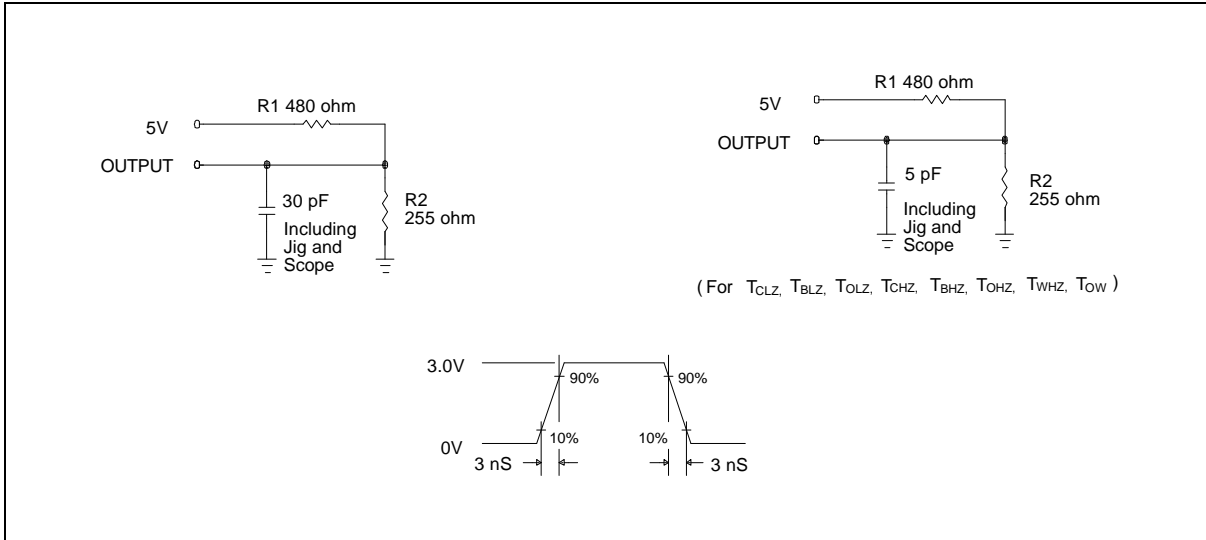

## Read Cycle

( $V_{DD} = 5V \pm 10\%$ ,  $V_{SS} = 0V$ ,  $T_A = 0$  to  $70^\circ C$ )

PARAMETER	SYM.	W26020A-20		W26020A-25		UNIT
		MIN.	MAX.	MIN.	MAX.	
Read Cycle Time	TRC	20	-	25	-	nS
Address Access Time	TAA	-	20	-	25	nS
Chip Select Access Time	TACS	-	20	-	25	nS
Output Enable to Output Valid	TAOE	-	10	-	12	nS
$\overline{UB}$ , $\overline{LB}$ Access Time	TBA	-	10	-	12	nS
Output Hold from Address Change	TOH	4	-	5	-	nS
Chip Select to Output in Low Z	$T_{CLZ}^*$	3	-	5	-	nS
Chip Deselect to Output in High Z	$T_{CHZ}^*$	-	10	-	12	nS
Output Enable to Output in Low Z	$T_{OLZ}^*$	0	-	0	-	nS
Output Disable to Output in High Z	$T_{OHZ}^*$	-	10	-	12	nS
$\overline{UB}$ , $\overline{LB}$ Select to Output in Low Z	$T_{BLZ}^*$	0	-	0	-	nS
$\overline{UB}$ , $\overline{LB}$ Deselect to Output in High Z	$T_{BHZ}^*$	-	10	-	12	nS

\* These parameters are sampled but not 100% tested.



AC Characteristics, continued

## Write Cycle

PARAMETER	SYM.	W26020A-20		W26020A-25		UNIT
		MIN.	MAX.	MIN.	MAX.	
Write Cycle Time	TWC	20	–	25	–	nS
Chip Select to End of Write	TCW	14	–	15	–	nS
Address Valid to End of Write	TAW	17	–	18	–	nS
Address Setup Time	TAS	0	–	0	–	nS
$\overline{UB}$ , $\overline{LB}$ Select to End of Write	TBW	17	–	18	–	nS
Write Pulse Width	TWP	17	–	18	–	nS
Write Recovery Time	$\overline{CS}$ , $\overline{WE}$	TWR	0	–	–	nS
Data Valid to End of Write	TDW	10	–	12	–	nS
Data Hold from End of Write	TDH	0	–	0	–	nS
Write to Output in High Z	TWHZ*	–	10	–	12	nS
End of Write to Output Active	TOW*	5	–	5	–	nS

\* These parameters are sampled but not 100% tested.

## TIMING WAVEFORMS

### Read Cycle 1

(Address Controlled,  $\overline{CS} = \overline{OE} = \overline{UB} = \overline{LB} = V_{IL}$ ,  $\overline{WE} = V_{IH}$ )

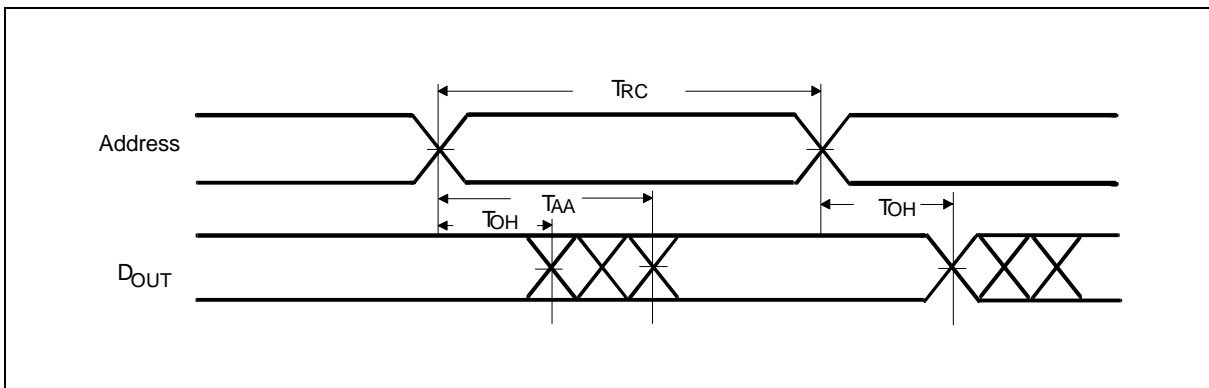



Timing Waveforms, continued

**Read Cycle 2**

(Chip Select Controlled,  $\overline{OE} = V_{IL}$ ,  $\overline{WE} = V_{IH}$ )

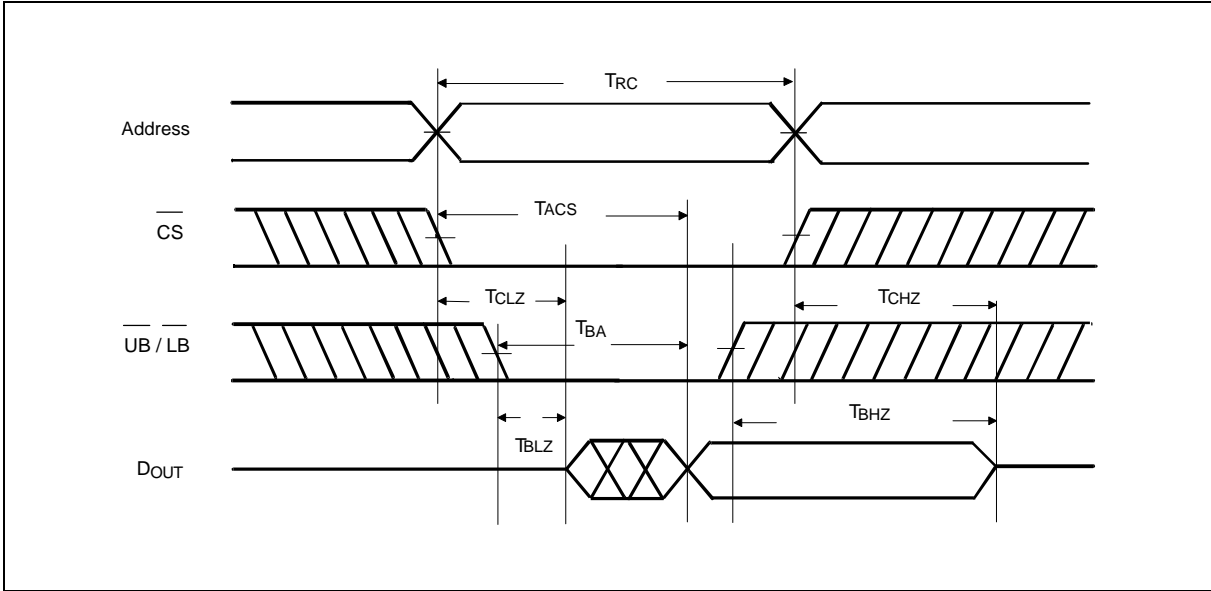

**Read Cycle 3**

(Output Enable Controlled,  $\overline{CS} = \overline{UB} = \overline{LB} = V_{IL}$ ,  $\overline{WE} = V_{IH}$ )

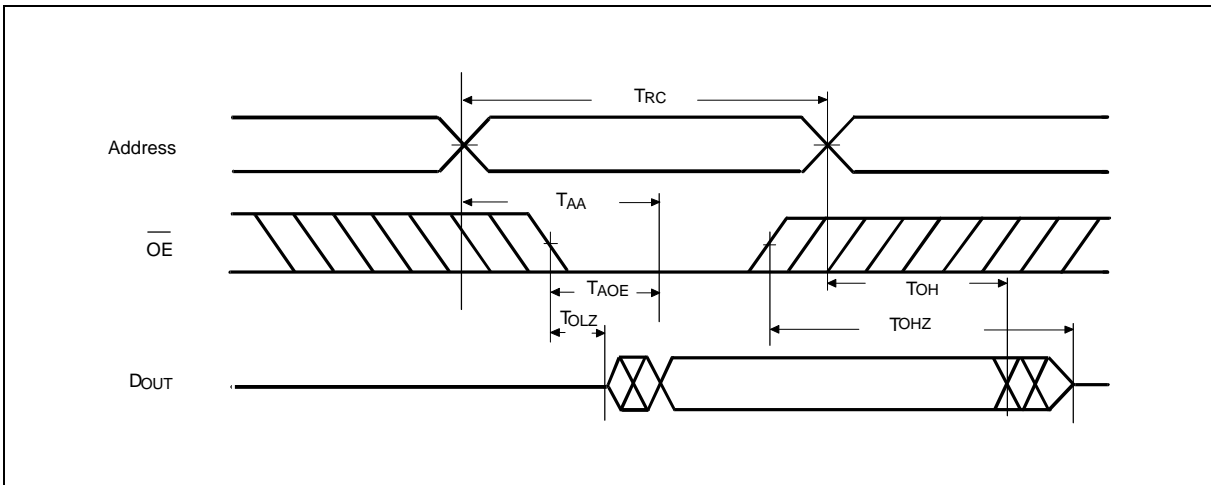

Timing Waveforms, continued

## Write Cycle 1

( $\overline{\text{OE}}$  Clock)

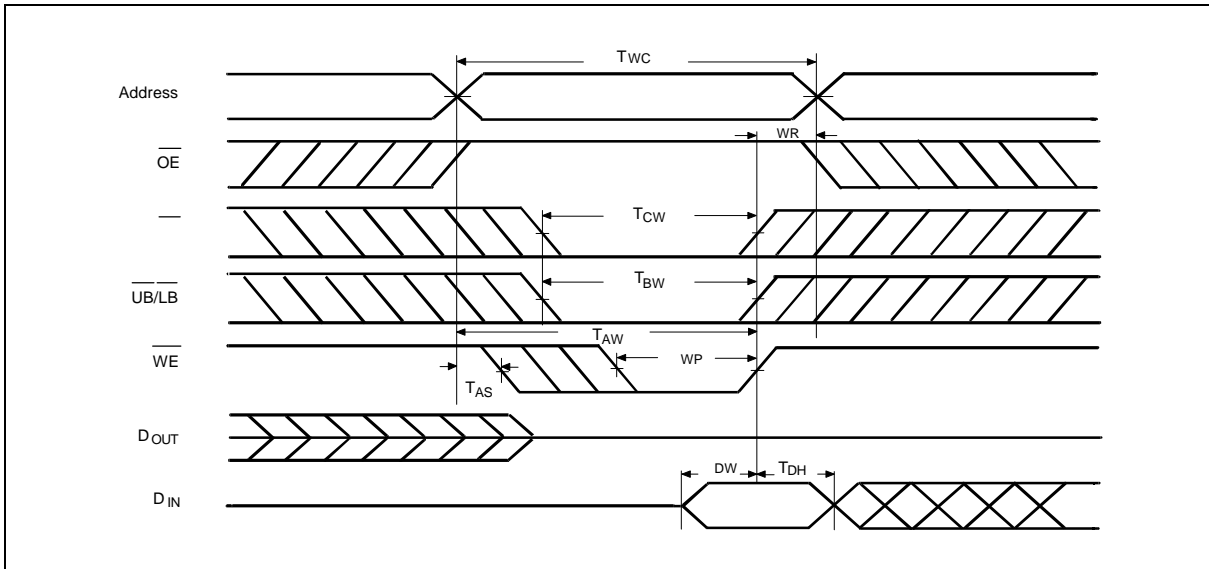

## Write Cycle 2

( $\overline{\text{OE}} = V_{IL}$  Fixed)

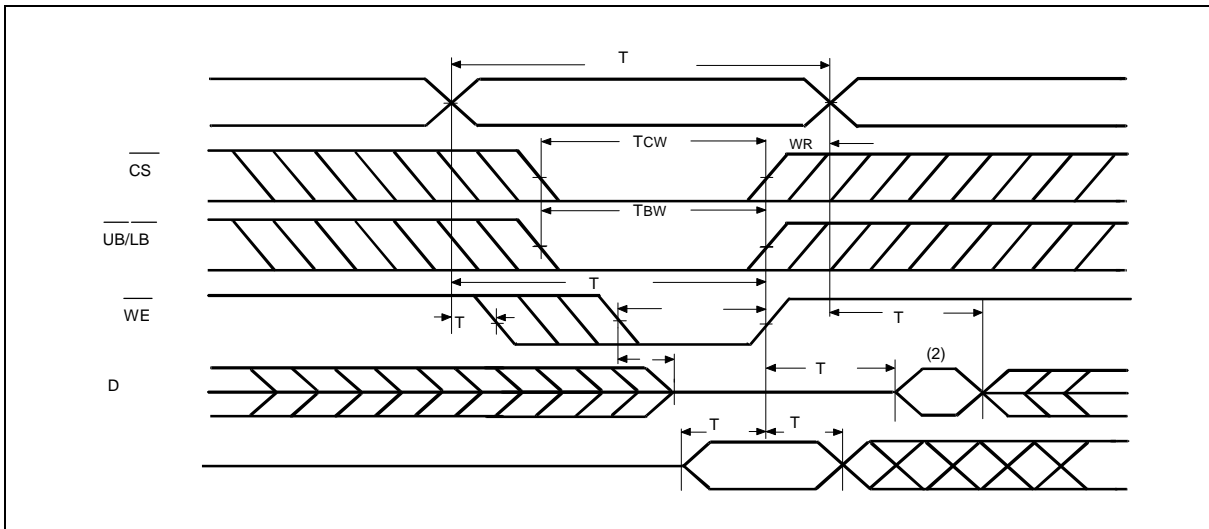

Notes:

1. During this period, I/O pins are in the output state, so input signals of opposite phase to the outputs should not be applied.
2. The data output from DOUT are the same as the data written to DIN during the write cycle.
3. DOUT provides the read data for the next address.
4. Transition is measured  $\pm 500$  mV from steady state with  $C_L = 5$  pF. This parameter is guaranteed but not 100% tested.



## ORDERING INFORMATION

<b>PART NO.</b>	<b>ACCESS TIME (nS)</b>	<b>OPERATING CURRENT MAX. (mA)</b>	<b>STANDBY CURRENT MAX. (mA)</b>	<b>PACKAGE</b>
W26020AT-20	20	220	10	44-pin type two TSOP
W26020AT-25	25	200	10	44-pin type two TSOP

Notes:

1. Winbond reserves the right to make changes to its products without prior notice.
2. Purchasers are responsible for performing appropriate quality assurance testing on products intended for use in applications where personal injury might occur as a consequence of product failure.



## PACKAGE DIMENSIONS

### 44-pin Standard Type Two TSOP

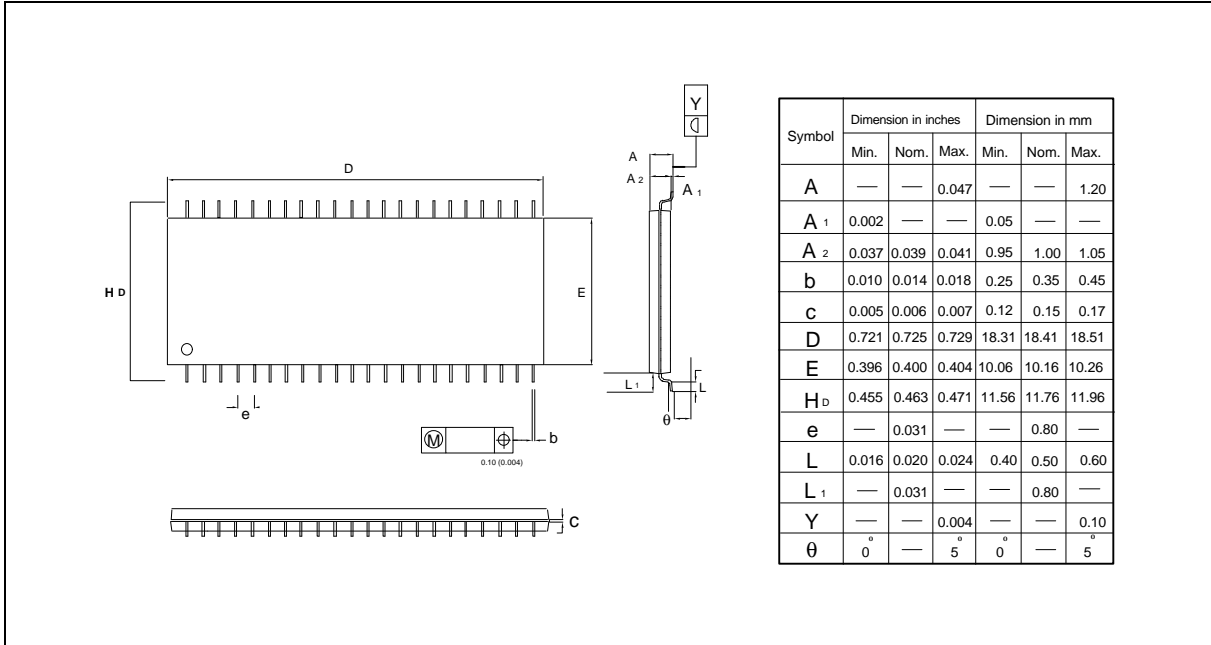



## VERSION HISTORY

VERSION	DATE	PAGE	DESCRIPTION
A1	Jan. 1998		Initial Issued
A2	May. 1998	1	Power consumption 1.3W to 1.5W Modify pin configuration
		4	TOH from 3 to 4 for-20, TOH from 3 to 4 for-25 TCLZ* from 3 to 5 for-25
		5	Tcw from 13 to 12 for-15, Tcw from 17 to 14 for-20 Tcw from 18 to 15 for-25, TWP from 10 to 13 for-15 TWP from 12 to 17 for-20, TWP from 15 to 18 for-25 TOW from 0 to 3 for-15, TOW from 0 to 5 for-20 TOW from 0 to 5 for-25
A3	Jul. 1998	1, 3, 4, 5, 8, 9	Delete 15 nS and SOJ item



### Headquarters

No. 4, Creation Rd. III,  
Science-Based Industrial Park,  
Hsinchu, Taiwan  
TEL: 886-3-5770066  
FAX: 886-3-5796096  
<http://www.winbond.com.tw/>  
Voice & Fax-on-demand: 886-2-27197006

### Taipei Office

11F, No. 115, Sec. 3, Min-Sheng East Rd.,  
Taipei, Taiwan  
TEL: 886-2-27190505  
FAX: 886-2-27197502

### Winbond Electronics (H.K.) Ltd.

Rm. 803, World Trade Square, Tower II,  
123 Hoi Bun Rd., Kwun Tong,  
Kowloon, Hong Kong  
TEL: 852-27513100  
FAX: 852-27552064

### Winbond Electronics North America Corp.

**Winbond Memory Lab.**  
**Winbond Microelectronics Corp.**  
**Winbond Systems Lab.**  
2727 N. First Street, San Jose,  
CA 95134, U.S.A.  
TEL: 408-9436666  
FAX: 408-5441798

Note: All data and specifications are subject to change without notice.