

# 5-channel high current driver

## BA612

The BA612 is a high-current driver IC, and contains an array of five Darlington transistors, each with input resistance. Input and output can be directed in the same direction using DIP Pin 14, with the layout optimized to facilitate mounting.

●Applications

- Hammer solenoid drivers
- Relay drivers
- LED drivers

●Features

- 1) 5-circuit Darlington transistor array.
- 2) Large current (up to 400mA) can be driven.
- 3) Input and output pins are aligned in the same direction, for easy mounting.
- 4) High current transfer ratio.
- 5) Can be coupled with MOS ICs.

●Block diagram

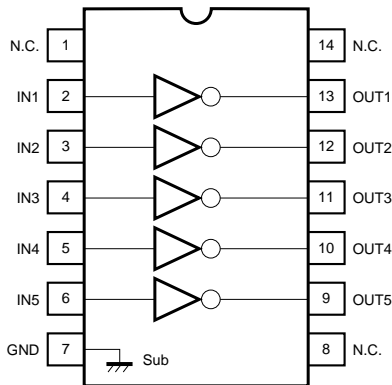

● Absolute maximum ratings (Ta = 25°C)

Parameter	Symbol	Limits	Unit
Power supply voltage	V <sub>CC</sub>	24	V
Power dissipation	P <sub>d</sub>	550*	mW
Operating temperature	T <sub>opr</sub>	- 25 ~ + 75	°C
Storage temperature	T <sub>stg</sub>	- 55 ~ + 125	°C
Collector current	I <sub>c</sub>	450	mA
Input pin voltage withstanding ( + )	V <sub>IN +</sub>	24	V
Input pin voltage withstanding ( - )	V <sub>IN -</sub>	- 0.5	V

\* Reduced by 5.5mW for each increase in Ta of 1°C over 25°C

● Internal circuit configuration

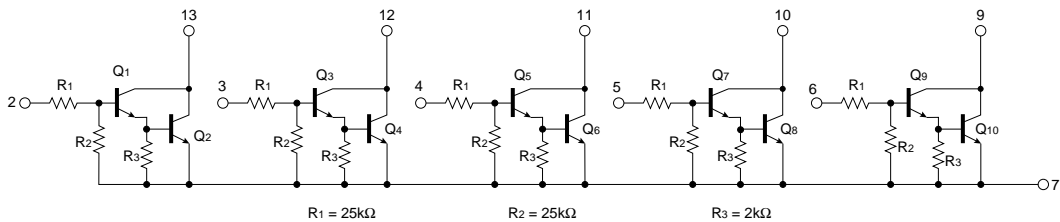

Fig.1

● Electrical characteristics (unless otherwise noted, Ta = 25°C)

Parameter	Symbol	Min.	Typ.	Max.	Unit	Conditions	Measurement circuit
Usage voltage range	V <sub>CC</sub>	—	—	20	V	—	—
Output leakage current	I <sub>L</sub>	—	—	100	μA	V <sub>CC</sub> = 26V, V <sub>IN</sub> = 0V	Fig.10
Output current (1 circuit)	I <sub>OUT</sub>	—	—	400	mA	When only 1 circuit is on	Fig.11
Output current (5 circuits)	I <sub>OUT</sub>	—	Fig.3	—	—	DC per circuit when all 5 circuits are on at once	—
Collector saturation voltage	V <sub>CE (sat)</sub>	—	—	2.0	V	I <sub>OUT</sub> = 400mA, V <sub>IN</sub> = 17V	Fig.11
DC current transfer ratio	h <sub>FE</sub>	2000	—	—	—	—	—
Input current	I <sub>IN</sub>	—	0.6	1.0	mA	V <sub>IN</sub> = 17V, I <sub>OUT</sub> = 0mA	Fig.11

● Electrical characteristic curves

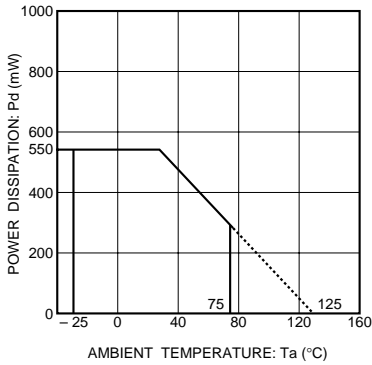

Fig.2 Power dissipation vs. ambient temperature

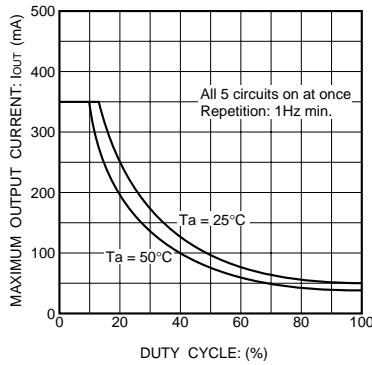

Fig.3 Output current vs. duty cycle

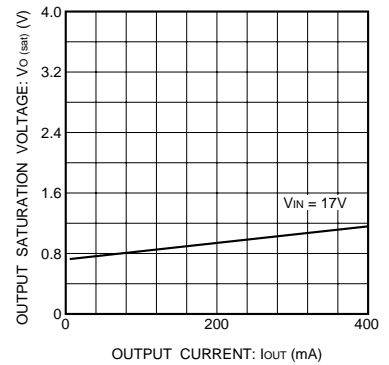

Fig.4 Output saturation voltage vs. output current

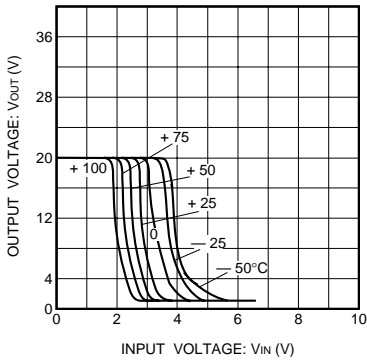

Fig.5 Output voltage vs. input voltage (temperature characteristic)

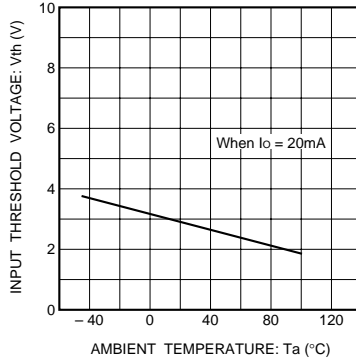

Fig.6 Input threshold voltage vs. ambient temperature

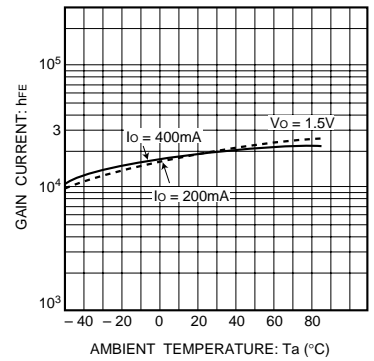

Fig.7 DC current amplification ratio vs. ambient temperature ( I ) (when Vo = 1.5V)

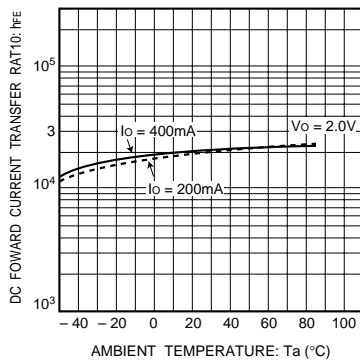

Fig.8 DC current amplification ratio vs. ambient temperature ( II ) (when Vo = 2V)

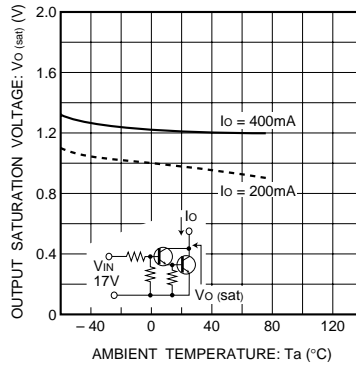

Fig.9 Output saturation voltage vs. ambient temperature

● Measurement circuit

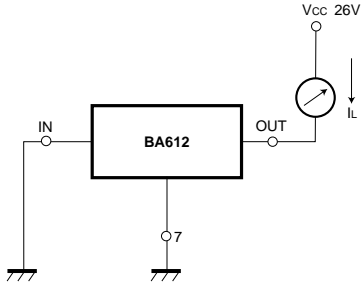

Fig.10

● Application example

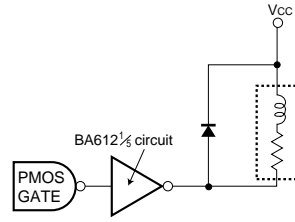

Fig.12

Connections should be made as shown in Figure 12 if inductive load is being driven. A clamp diode has to be added in series with the load to suppress surges in the inductive load.

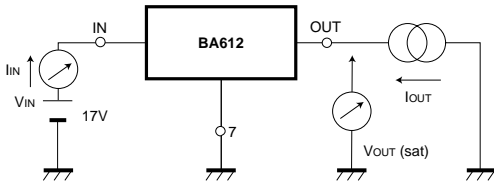

Fig.11

● External dimensions (Units: mm)

