

SERIES M

SUBMINIATURE/MULTI-FUNCTION

A-25-13

DISTINCTIVE FEATURES

Antirotation feature is standard on noncylindrical levers.

Antijamming design on toggle switches protects contacts from damage due to excessive downward force on the actuator.

High torque bushing construction prevents rotation or separation from frame during installation.

Stainless steel frame resists corrosion.

Patented silver contacts of specially composed alloy for hardness.

High insulating barriers, formed in the molded diallylphthalate case, increase isolation of circuits in multipole devices and provide added protection to contact points.

Epoxy sealed terminals prevent entry of solder flux and other contaminants.

Prominent external insulating barriers increase insulation resistance and dielectric strength.

Interlocked actuator block prevents switch failure due to biased lever movement.

Longer center solder lug terminal simplifies wiring and soldering.

Clinching of the frame to the case well above the base and terminals provides 1500V dielectric strength.

Actual Size



Toggle
Rockers
Pushbuttons
Slides

NHK[®] SERIES M TOGGLE SWITCHES

A-25-13

Toggles

SUBMINIATURE/MULTI-FUNCTION

GENERAL SPECIFICATIONS

Electrical Capacity: (Resistive Load)	6A @ 125V AC & 3A @ 250V AC 6A @ 30V DC 0.4VA maximum @ 28V AC/DC maximum (Applicable Range 0.1mA ~ 0.1A @ 20mV ~ 28V)
Contact Resistance:	10 milliohms maximum for silver 20 milliohms maximum for gold
Insulation Resistance:	1,000 megohms minimum @ 500V DC
Dielectric Strength:	1,000V AC minimum between contacts 1,500V AC minimum between contacts and case
Mechanical Life:	100,000 operations minimum 50,000 operations minimum for flat, locking, & splashproof devices
Electrical Life:	25,000 operations minimum for silver 50,000 operations minimum for gold
Ambient Temp Range:	-15°C through +85°C (+5°F through +185°F) Optional low temperature lubricant available
Toggle Angle of Throw:	25°
Nominal Operating Force:	400 grams for Single Pole 450 grams for Double Pole 700 grams for Three Pole 800 grams for Four Pole

MATERIALS & FINISHES

Toggle	Brass with chrome plating
Bushing	Brass with nickel plating
Frame	Stainless steel
Case	Diallylphthalate resin (UL 94V-0)
Movable Contactor	Phosphor bronze with silver or gold plating*
Movable Contacts	Silver alloy (code W); or silver alloy with gold plating* over nickel (code A); or copper with gold plating* over nickel (code G)
Stationary Contacts	Silver with silver plating (code W); or silver with gold plating* over nickel (code A); or copper or brass with gold plating* over nickel (code G)
Terminals	Copper or brass with silver plating; or copper or brass with gold plating over nickel

* Gold plating on contacts is 1 micron minimum.

BIAS GUARD

When the lever is pushed in a diagonal direction instead of the mechanism's direction of operation, biased movement is transmitted to the actuator block and causes misalignment of contacts. However, internal construction of the M Series case prevents this biased movement.

ANTIROTATION DESIGN

Three of the M Series toggle types are designed with the antirotation feature: the flatted toggles which are coded E, E2, E3, E4, F and R; the locking levers L and L1; and the snap top toggles which receive the paddle cap and which are coded K1 and K2.

The bottom portion of all these toggles has two flatted sides which fit into a complementary opening inside the bushing. Turning of the toggle is prevented by the specially designed fit of these two structures.



NKK® SERIES M TOGGLE SWITCHES

SUBMINIATURE/MULTI-FUNCTION/UNBRACKETED

TYPICAL UNBRACKETED



POLES	
1	SPST SPDT
2	DPST DPDT SP3T
3	3PDT
4	4PDT DP3T

TOGGLES

S	.413" Bat
S2	.200" Bat
S3	.256" Bat
E	.450" Flatted
E2	.256" Flatted
E3	.646" Flatted
*E4	.840" Flatted
F	.450" Flatted for Splashproof
Q	.550" Cone
Q2	.640" Cone
*Q4	.840" Cone
M	.748" Column
*C	.571" Color Tipped Cone
*D	.840" Color Capped Cone
*N	.748" Color Tipped Column
K1	.370" Paddle
K2	.559" Paddle

Toggle dimensions are based on use with .350" bushing; add .070" to toggle length when combining with a .280" bushing. Specify cap color for toggles C, D, N, K1 & K2 at the end of the part number.
* Available on 1 & 2 pole only.

L	.201" Dia. Locking Lever
L1	.214" Dia. Locking Lever

B	.453" Large Bat
B2	.689" Large Bat
R	.610" Large Flatted

BUSHINGS

1/4"-40 Dia. Threaded & .244 Dia. Smooth	
S1	.350" Threaded with Keyway
S2	.350" Smooth with Keyway
D1	.350" Threaded with D Flat
A1	.280" Threaded with Keyway
A2	.280" Smooth with Keyway
D3	.350" Threaded Splashproof with D Flat (combines only with S, S2, S3, and F toggles)
6mm Diameter Threaded	
S4	.350" Threaded with Keyway

1/4"-40 Dia. Threaded & .244" Dia. Smooth	
L1	Threaded with Keyway for Lever Lock
L2	Smooth with Keyway for Lever Lock
L3	.295" Threaded Splashproof with D Flat for Lever Lock

12mm Diameter Threaded	
B1	Large .472" Threaded with Keyway
B3	Large .472" Threaded Splashproof with D Flat

CIRCUITS

*1	ON	NONE	OFF
2	ON	NONE	ON
3	ON	OFF	ON
5	ON	NONE	(ON)
8	(ON)	OFF	(ON)
9	ON	OFF	(ON)
**4	ON	ON	ON
**6	(ON)	ON	(ON)
**7	ON	ON	(ON)

() = Momentary
* ON-NONE-OFF circuit available in 1- and 2-pole only.
** 3-ON circuits available with 2- and 4- pole bases only.

SWITCH ORDERING EXAMPLE



CONTACT MATERIALS & RATINGS	
W	Silver Rated 6A @ 125V AC & 3A @ 250V AC
A	Gold over Silver Rated 6A @ 125 AC & 0.4VA max @ 28V AC/DC max
G	Gold Rated 0.4VA max @ 28V AC/DC max

OPTIONAL CAPS	
B	For S Bat Toggle
C	Conical Cap for S Bat Toggle
R	For B Toggle
V	For B2 Toggle

CAP COLORS	
A	Black
B	White
C	Red
E	Yellow
F	Green
G	Blue

TERMINALS	
01	Solder Lug
02	Quick Connect
03	.250" Straight PC
05	.425" Wirewrap
06	.750" Wirewrap
07	.964" Wirewrap
08	1.062" Wirewrap

DESCRIPTION FOR TYPICAL ORDERING EXAMPLE (M2013SS1W01)

SERIES M TOGGLE

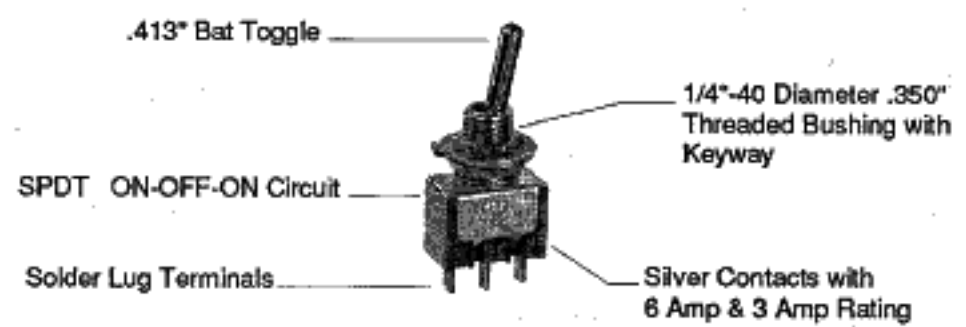

IMPORTANT: Switches are supplied without UL & CSA marking unless specified. See Supplement for instructions.

NKK® SERIES M TOGGLE SWITCHES

A-25-13

SUBMINIATURE/MULTI-FUNCTION/UNBRACKETED

POLES AND CIRCUITS						
POLE & THROW	MODEL	TOGGLE POSITION & TERMINAL NUMBERS			SCHEMATICS	
		() = Momentary				
		Down 	Center 	Up 		
SPST	M2011	ON	NONE	OFF		
CONNECTED TERMINALS		2-3	OPEN	OPEN		
SPDT	M2012	ON	NONE	ON		
	M2013	ON	OFF	ON		
	M2015*	ON	NONE	(ON)		
	M2018	(ON)	OFF	(ON)		
	M2019*	ON	OFF	(ON)		
CONNECTED TERMINALS		2-3	OPEN	2-1		
DPST	M2021	ON	NONE	OFF		
CONNECTED TERMINALS		2-3 5-6	OPEN	OPEN		
DPDT	M2022	ON	NONE	ON		
	M2023	ON	OFF	ON		
	M2025*	ON	NONE	(ON)		
	M2028	(ON)	OFF	(ON)		
	M2029*	ON	OFF	(ON)		
CONNECTED TERMINALS		2-3 5-6	OPEN	2-1 5-4		
3PDT	M2032	ON	NONE	ON		
	M2033	ON	OFF	ON		
	M2035	ON	NONE	(ON)		
	M2038	(ON)	OFF	(ON)		
	M2039	ON	OFF	(ON)		
CONNECTED TERMINALS		2-3 5-6 8-9	OPEN	2-1 5-4 8-7		
4PDT	M2042	ON	NONE	ON		
	M2043	ON	OFF	ON		
	M2045	ON	NONE	(ON)		
	M2048	(ON)	OFF	(ON)		
	M2049	ON	OFF	(ON)		
CONNECTED TERMINALS		2-3 5-6 8-9 11-12	OPEN	2-1 5-4 8-7 11-10		
* Reverse circuits available upon request. Terminal numbers are not actually on switches.						
SP3T	M2024	ON	ON	ON	The SP3T model is a conversion of the DPDT.	
	M2026	(ON)	ON	(ON)		
M2027	ON	ON	(ON)			
CONNECTED TERMINALS W/O EXTERNAL CONNECTIONS		2-3 5-6	2-3 5-4	2-1 5-4		
SCHEMATIC WITH EXTERNAL CONNECTIONS					The DP3T model is a conversion of the 4PDT.	
DP3T	M2044	ON	ON	ON	The external connections must be made during field installation.	
	M2046	(ON)	ON	(ON)		
M2047	ON	ON	(ON)			
CONNECTED TERMINALS W/O EXTERNAL CONNECTIONS		2-3 5-6 8-9 11-12	2-3 5-4 8-9 11-10	2-1 5-4 8-7 11-10		
SCHEMATIC WITH EXTERNAL CONNECTIONS						

NKH® SERIES M TOGGLE SWITCHES

SUBMINIATURE/MULTI-FUNCTION/UNBRACKETED

TOGGLES

All the toggles are brass with a standard finish of bright chrome; satin chrome and black finishes are available on request to the factory. Toggle dimensions are based on combination with the .350" bushing; add .070" to toggle length when combined with the .280" bushing.

<p>S .413" Bat</p> 	<p>S2 .200" Bat</p> 	<p>S3 .256" Bat</p> 	<p>E .450" Flatted</p> 	<p>E2 .256" Flatted</p> 
<p>E3 .646" Flatted</p> 	<p>E4 .840" Flatted (available on 1 & 2-pole only)</p> 	<p>F .450" Flatted for Splashproof</p> 	<p>Q .550" Cone</p> 	<p>Q2 .640" Cone</p> 
<p>Q4 .840" Cone (available on 1 & 2-pole only)</p> 	<p>M .748" Column</p> 	<p>C .571" Color Tipped Cone (available on 1 & 2-pole only)</p>  <p>Supplied with Cap AT445 Polycarbonate</p>	<p>D .840" Color Capped Cone (available on 1 & 2-pole only)</p>  <p>Supplied with Cap AT460 Polyethylene</p>	<p>N .748" Color Tipped Column (available on 1 & 2-pole only)</p>  <p>Supplied with Cap AT441 Polypropylene</p>
<p>K1 .370" Paddle</p> <p>Supplied with Cap AT467 Nylon</p>   		<p>K2 .559" Paddle</p> <p>Supplied with Cap AT468 Nylon</p>   		
<p>Colors Available: A Black B White C Red E Yellow F Green G Blue (H Gray is also available for AT467 & AT468) For toggles C, D, N, K1 & K2 the cap color code must be specified at the end of the part number.</p>				

NKK SERIES M TOGGLE SWITCHES

SUBMINIATURE/MULTI-FUNCTION/UNBRACKETED

TOGGLES

Locking toggles are brass with chrome plating, while the standard caps supplied with these toggles are nickel plated. A color code must be specified at the end of the part number to order the optional colored or brushed aluminum caps. Locking toggles can be combined only with L1, L2, and L3 bushings.

L .201" Dia. Locking Lever

Supplied with Cap AT427

Standard: Nickel Plated Brass

Optional: Colored or Brushed Aluminum



L1 .214" Dia. Locking Lever

Supplied with Cap AT076

Standard: Nickel Plated Brass

Optional: Colored or Brushed Aluminum



Colors & Finish for Optional Aluminum: A Black C Red G Blue 9 Brushed Aluminum

LOCKING MECHANISM



Circuit Code 2
2 Position Lock



Circuit Code 5
1 Position Lock



Circuit Codes 7 and 9
2 Position Lock



Circuit Codes 3 and 4
3 Position Lock



Circuit Codes 6 and 8
1 Position Lock

Large toggles are brass with a standard finish of bright chrome; satin chrome and black finishes are available on request to the factory. These large toggles can be combined only with 12mm bushings.

B .453" Large Bat



B2 .689" Large Bat



R .610 Large Flatted



OPTIONAL CAPS

B AT415 For S Bat Toggle

Polyethylene



C AT444 Conical Cap for S Bat Toggle

Polyethylene



R AT434 For B Toggle

Vinyl Chloride

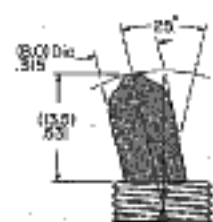

V AT406 For B2 Toggle

Vinyl Chloride



Colors Available: A Black B White C Red E Yellow F Green G Blue

NKK SERIES M TOGGLE SWITCHES

Toggles

SUBMINIATURE/MULTI-FUNCTION/UNBRACKETED

BUSHINGS

1/4"-40 Diameter & 6mm Threaded & .244" Diameter Smooth

12mm Diameter Threaded

S1 .350" Threaded w/Keyway
1/4"-40

S4 6mm

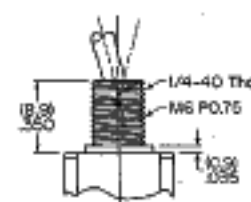
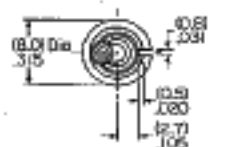

S2 .350" Smooth w/Keyway



D1 .350" Threaded w/D Flat



B1 Large .472" Threaded w/Keyway

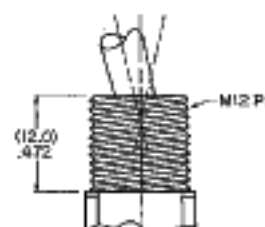

A1 .280" Threaded w/Keyway

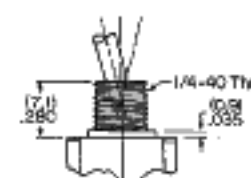

A2 .280" Smooth w/Keyway

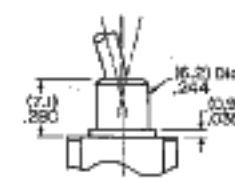

D3 .350" Threaded Splashproof w/D Flat

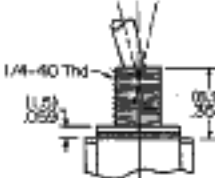

Combines only w/S, S2, S3, & F toggles.

B3 Large .472" Threaded Splashproof w/D Flat

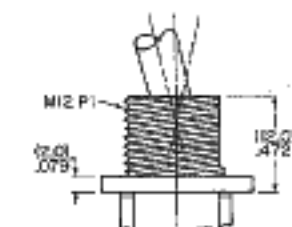
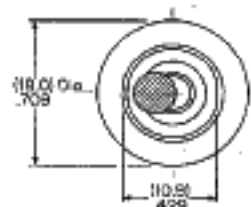

L1 Threaded w/Keyway for Lever Lock

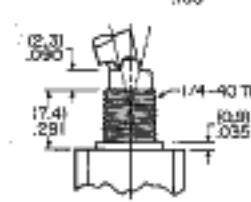
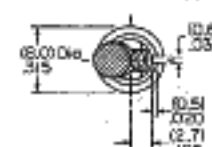

L2 Smooth w/Keyway for Lever Lock

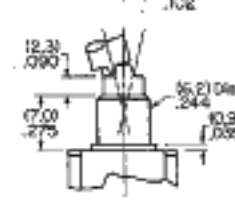
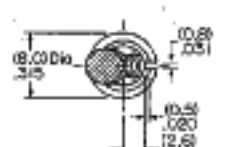

L3 .295" Threaded Splashproof w/D Flat for Lever Lock

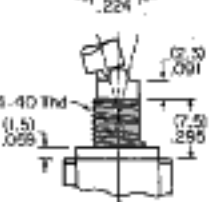
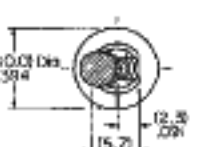

CONTACT MATERIALS & RATINGS

W Silver over Silver
Rated 6A @ 125V AC
& 3A @ 250V AC

A Gold over Silver
Rated 6A @ 125V AC
& 0.4VA maximum @
28V maximum AC/DC

G Gold over Brass or Copper
Rated 0.4VA maximum @
28V maximum AC/DC

NKK[®] SERIES M TOGGLE SWITCHES

SUBMINIATURE/MULTI-FUNCTION/UNBRACKETED

TERMINALS & FOOTPRINTS

01 Solder Lug



02 .062" Wide Quick Connect



Typical mating connector
AMP #60900-1

03 .250" Straight PC



Wirewrap

05 .425" (10.8mm)

06 .750" (19.05mm)

07 .964" (24.5mm)

08 1.062" (27.0mm)



Single Pole



Double Pole

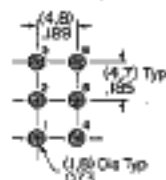

Three Pole



Four Pole

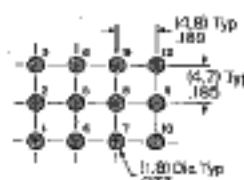

Soldering Time & Temperature Limits:

3 seconds at 350°C or
5 seconds at 270°C.

Wiring Specs:

Solder lug terminals have a
.043" X .079" oblong hole which accommodates
1 solid 18-gauge wire or 2 solid or stranded 20-gauge wires.

Solder Lug/Single & Double Pole

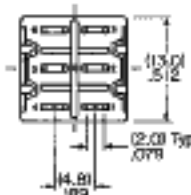
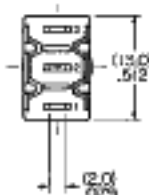
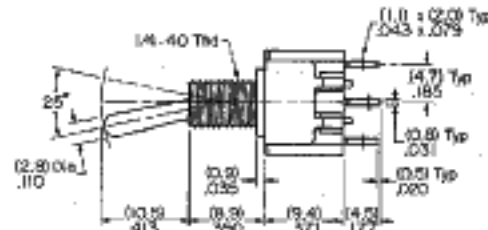
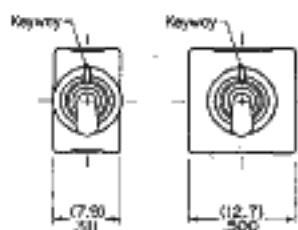

M2012SS1WO1 Model Shown

M2011 & M2021 models do not have terminals 1 & 4.

Solder Lug/Three & Four Pole

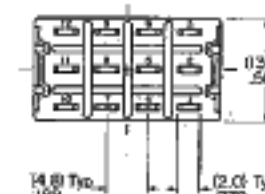
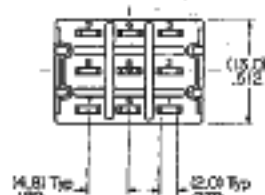
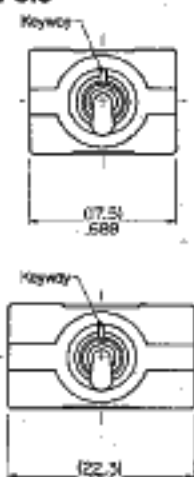

M2042SS1WO1 Model Shown

