

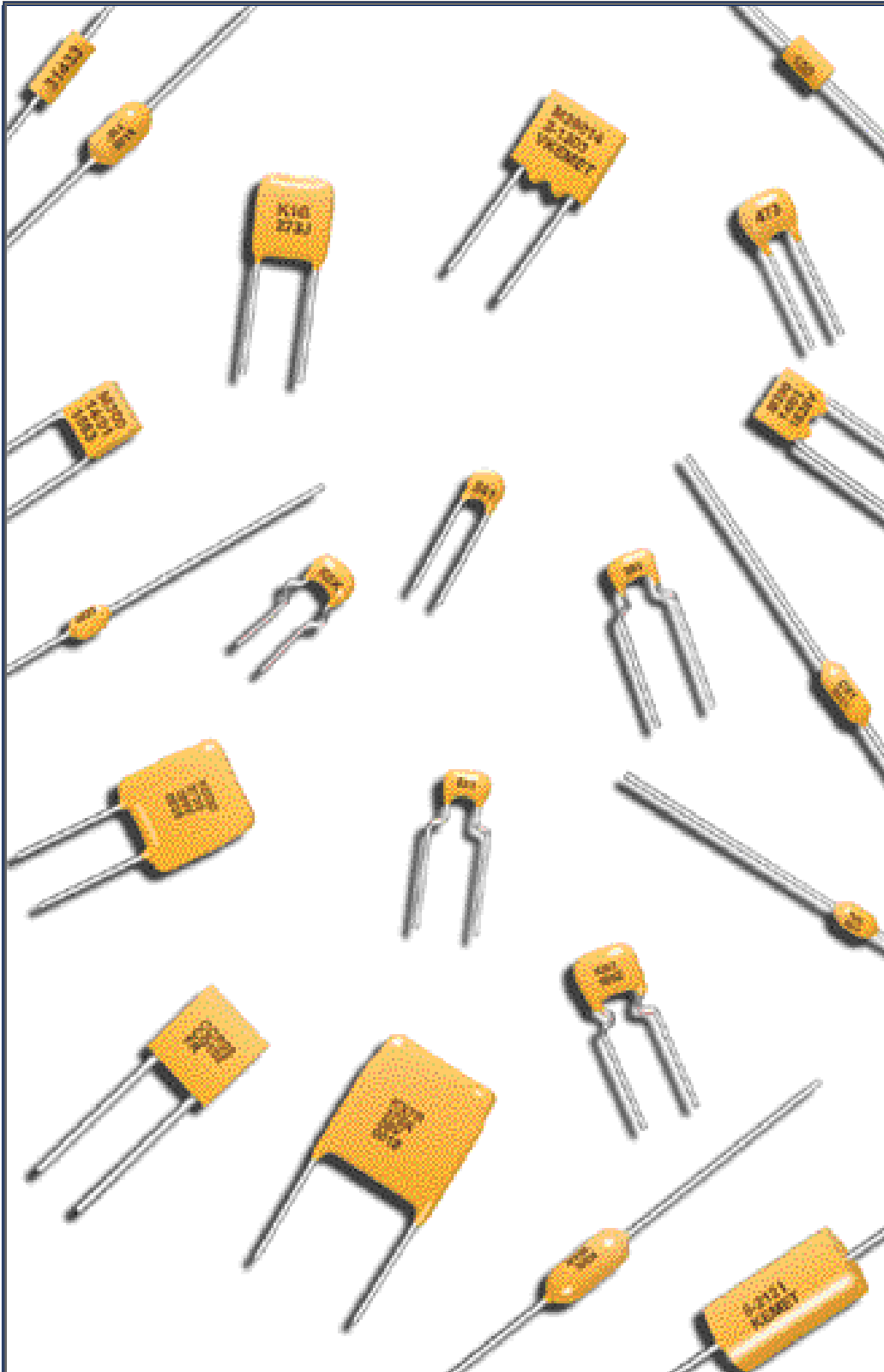

CERAMIC LEADED CAPACITORS



To find parts fast, visit *CapacitorEdge*sm at www.kemet.com.

KEMET CAPACITORS MILITARY SPECIFICATIONS ON BACK

| | |
|---|--|
| <p>CERAMIC CHIPS (Surface Mounted Device) 0.5 pF-4.7μF</p> <p>*0402 *0603 *0805 *1206 *1210</p> <p>*1812 *1825 2220 2225</p> <p>*1632 Array *EIA Standard Style</p> <p>CONFORMALLY COATED RADIAL Golden Max 1pF-6.8μF</p> <p>C315 C320 C322 C323 C326</p> <p>C330 C333 C340 C350</p> <p>CONFORMALLY COATED AXIAL Aximax 10pF-1μF</p> <p>C410 C412 C420 C430 C440</p> <p>MOLDED RADIAL 1pF-1.0μF</p> <p>C052 (CK05) (CKR05) C062 (CK06) (CKR06) C056 (CKR06) C066 (CKR06)</p> <p>MOLDED AXIAL 1pF-3.3μF</p> <p>C114 (CK13) (CKR11) C124 (CK13) (CKR12) C192 (CK14) (CKR14) C202 (CK15) (CKR15) C222 (CK16) (CKR16)</p> | <p>TANTALUM CHIPS (Surface Mounted Device) 0.1-470μF</p> <p>T491 Industrial T492 Military T494 Low ESR Industrial T495 Low ESR Surge Arrestor T496 Power T510 UltraLow ESR</p> <p>S A T B U C V D X (321HL) (321L) (352BL) (352B) (4032L) (6032) (7343L) (7343) (7343H)</p> <p>Case Sizes - KEMET (EIA)</p> <p>CONFORMALLY COATED RADIAL Ultradip T350 Series 0.1-680μF</p> <p>T350 T351 T352 T353 T354 T355 T356</p> <p>T36X Series 0.1-330μF</p> <p>T363 (CX03) T368 T369 (CX12)</p> <p>MOLDED AXIAL 0.1-330μF</p> <p>T322/T323 (CX01/CX05) A, B, C, D, E, F Case Sizes</p> <p>HERMETICALLY SEALED 0.0047-1200μF</p> <p>T110, T140, T210 (GR500), T212 (CSR13), T216 (CSS13), T222, T240 (GR500), T242 (CSR23), T252 (CSR33), T256, T262 (CSR21) Series</p> <p>MOLDED RADIAL T330 Series 0.1-220μF T340 Series 0.1-330μF</p> <p>MICRON 0.68-220μF T370 Series T378 Series (CX06)</p> |
|---|--|

KEMET Electronics Corporation • Post Office Box 5828 • Greenville, South Carolina 29606 • (864)963-6300

GR900 and MIL-PRF-123 High-Reliability Ceramic Capacitors are available. Refer to catalog F-3054 for detailed information. KEMET also manufactures Tantalum Leaded, and Surface Mount Capacitors — Tantalum and Ceramic. Refer to catalog F-3100 — Tantalum Leaded, and F3102 — Surface Mount for detailed information on these products.

| | |
|--|----------|
| Multilayer Ceramic Capacitors/Axial & Radial | Page |
| General Information | .4 |
| Conformally Coated/Axial & Radial | |
| Performance Characteristics | |
| General Specifications | .5 |
| Electrical | .5 |
| Environmental | .5 |
| “Aximax” Conformally Coated Axial | |
| Outline Drawing | .6 |
| Dimensions | .6 |
| Ordering Information | .6 |
| Marking | .6 |
| Part Number Reference | .7 |
| “Golden Max” Conformally Coated Radial | |
| Outline Drawings | .8 |
| Dimensions | .8 |
| Ordering Information | .8 |
| Marking | .9 |
| Part Number Reference | .9 - 11 |
| Optional Lead Configurations | .12 |
| Ceramic Molded/Axial & Radial | |
| Performance Characteristics | |
| General Specifications | .13 |
| Electrical | .13 |
| Environmental | .13 |
| Ceramic Molded Standard/Axial & Radial | |
| Outline Drawing | .14 |
| Dimensions | .14 |
| Ordering Information | .15 |
| Marking | .15 |
| Part Number Reference | .16 - 19 |
| Mil-PRF-20 | |
| Outline Drawings | .20 |
| Dimensions | .20 |
| Ordering Information | .21 |
| Marking | .21 |
| Part Number Reference | .22 - 25 |
| Mil-C-11015 (CK) & Mil-PRF-39014 (CKR) | |
| Outline Drawings | .26 |
| Dimensions | .26 |
| Ordering Information | .27 |
| Marking | .27 |
| Part Number Reference | .28 - 31 |
| Ceramic Axial Tape & Reel Packaging Specifications | .32 |
| Ceramic Radial Tape & Reel Packaging Specifications | .33 |
| Ceramic Leaded Packaging Quantities | .34 |
| Application Notes for Multilayer Ceramic Capacitors | .35 - 39 |

NOTICE

Although the information in this catalog has been carefully checked for accuracy, and is believed to be correct and current, no warranty, either express or implied, is made as to either its applicability to, or its compatibility with, specific requirements; nor does KEMET Electronics Corporation assume any responsibility for correctness of this information, nor for damages consequent to its use. All design characteristics, specifications, tolerances, and the like are subject to change without notice.

Multilayer ceramic capacitors are available in a variety of physical sizes and configurations, including leaded devices and surface mounted chips. Leaded styles include molded and conformally coated parts with axial and radial leads. However, the basic capacitor element is similar for all styles. It is called a chip and consists of formulated dielectric materials which have been cast into thin layers, interspersed with metal electrodes alternately exposed on opposite

edges of the laminated structure. The entire structure is fired at high temperature to produce a monolithic block which provides high capacitance values in a small physical volume. After firing, conductive terminations are applied to opposite ends of the chip to make contact with the exposed electrodes. Termination materials and methods vary depending on the intended use.

TEMPERATURE CHARACTERISTICS

Ceramic dielectric materials can be formulated with a wide range of characteristics. The EIA standard for ceramic dielectric capacitors (RS-198) divides ceramic dielectrics into the following classes:

Class I: Temperature compensating capacitors, suitable for resonant circuit application or other applications where high Q and stability of capacitance characteristics are required. Class I capacitors have predictable temperature coefficients and are not affected by voltage, frequency or time. They are made from materials which are not ferro-electric, yielding superior stability but low volumetric efficiency. Class I capacitors are the most stable type available, but have the lowest volumetric efficiency.

Class II: Stable capacitors, suitable for bypass or coupling applications or frequency discriminating circuits where Q and stability of capacitance characteristics are not of a major importance. Class II capacitors have temperature characteristics of $\pm 15\%$ or less. They are made from materials which are ferro-electric, yielding higher volumetric efficiency but less stability. Class II capacitors are affected by temperature, voltage, frequency and time.

Class III: General purpose capacitors, suitable for by-pass coupling or other applications in which dielectric losses, high insulation resistance and stability of capacitance characteristics are of little or no importance. Class III capacitors are similar to Class II capacitors except for temperature characteristics, which are greater than $\pm 15\%$. Class III capacitors have the highest volumetric efficiency and poorest stability of any type.

KEMET leaded ceramic capacitors are offered in the three most popular temperature characteristics:

C0G: Class I, with a temperature coefficient of 0 ± 30 ppm per degree C over an operating temperature range of -55°C to $+125^{\circ}\text{C}$ (Also known as "NP0").

X7R: Class II, with a maximum capacitance change of $\pm 15\%$ over an operating temperature range of -55°C to $+125^{\circ}\text{C}$.

Z5U: Class III, with a maximum capacitance change of $+22\% - 56\%$ over an operating temperature range of $+10^{\circ}\text{C}$ to $+85^{\circ}\text{C}$.

Specified electrical limits for these three temperature characteristics are shown in Table 1.

SPECIFIED ELECTRICAL LIMITS

| PARAMETER | TEMPERATURE CHARACTERISTICS | | |
|---|--|---|--|
| | C0G | X7R | Z5U |
| Dissipation Factor: Measured at following conditions: C0G — 1 kHz and 1 vrms if capacitance > 1000 pF 1 MHz and 1 vrms if capacitance \leq 1000 pF X7R — 1 kHz and 1 vrms* Z5U — 1 kHz and 0.5 vrms | 0.15% | 2.5% | 4.0% |
| Dielectric Strength: 2.5 times rated DC voltage. | Pass Subsequent IR Test | | |
| Insulation Resistance (IR): At rated DC voltage, whichever of the two is smaller | 1,000 M Ω - μ F or 100 G Ω | 1,000 M Ω - μ F or 100 G Ω | 1,000 M Ω - μ F or 10 G Ω |
| Temperature Characteristics: Range, $^{\circ}\text{C}$ Capacitance Change without DC voltage | -55 to 125 0 ± 30 ppm/ $^{\circ}\text{C}$ | -55 to 125 $\pm 15\%$ | +10 to 85 $+22\%, -56\%$ |

* 1 MHz and 1 vrms if capacitance \leq 100 pF on military product.

Table 1

GENERAL SPECIFICATIONS

| Working Voltage: | Axial | Radial |
|------------------|----------------|---------------------|
| C0G | 50 & 100 volts | 100 & 200 volts |
| X7R | 50 & 100 volts | 50, 100 & 200 volts |
| Z5U | 50 & 100 volts | 50 & 100 volts |

Temperature Characteristics:

| | |
|-----|---|
| C0G | 0 ± 30 PPM/°C from - 55°C to + 125°C ⁽¹⁾ |
| X7R | ± 15% from - 55°C to + 125°C |
| Z5U | + 22%; - 56% from + 10°C to + 85°C |

Capacitance Tolerance:

| | |
|-----|-------------------------------|
| C0G | ± 5%, ± 10%, ± 20% |
| X7R | ± 10%, ± 20% |
| Z5U | ± 20%, - 20 + 80%, - 0 + 100% |

Construction:

Epoxy encapsulated - meets flame test requirements of UL Standard 94V-0.
High-temperature solder - meets EIA RS-198D, Method 302, Condition B (260°C for 10 sec.)

Lead Material:

Solder Coated Copper Clad Steel

Solderability:

EIA RS-198D, Method 302, Solder temperature - 230° ± 5°C. Dwell time in solder - 7 ± 1/2 seconds.

Terminal Strength:

EIA RS-198D, Method 303, Condition A (2.2 kg)

ELECTRICAL @ 25°C

Capacitance:

Within specified tolerance at 25°C and following test conditions.
C0G - Greater than 1000 pF with 1.0 vrms at 1 kHz.
- 1000 pF and less with 1.0 vrms at 1 MHz.
X7R - with 1.0 vrms at 1 kHz.
Z5U - with 0.5 vrms at 1 kHz.

Dissipation Factor:

At 25°C - same test conditions as capacitance.
C0G - 0.15% maximum
X7R - 2.5% maximum
Z5U - 4.0% maximum

Insulation Resistance:

EIA RS-198D, Method 104, Condition A
C0G - 100 gigohms or 1000 megohm x µF, whichever is less.
X7R - 100 gigohms or 1000 megohm x µF, whichever is less.
Z5U - 10 gigohms or 1000 megohm x µF, whichever is less.

Dielectric Withstanding Voltage:

EIA RS-198D, Method 103 (250% of rated voltage for 5 seconds, with current limited to 50mA)

ENVIRONMENTAL

Vibration:

EIA RS-198D, Method 304, Condition D (10-2000 Hz; 20g)

Shock:

EIA RS-198D, Method 305, Condition I (100g)

Life Test:

EIA RS-198D, Method 201, Condition D. Test Potential and Temperature.
C0G- 200% of rated voltage at + 125°C
X7R - 200% of rated voltage at + 125°C
Z5U - 200% of rated voltage at + 85°C

Post-Test Limits at + 25°C are:

Capacitance Change:

C0G - ± 3%, or 0.25 pF, whichever is greater.
X7R - ± 20% of initial value. ⁽²⁾
Z5U - ± 30% of initial value. ⁽²⁾

Dissipation Factor:

C0G - 0.25% maximum
X7R - 3.0% maximum
Z5U - 4.0% maximum

Insulation Resistance:

C0G - 10 gigohms or 100 megohm x µF, whichever is less.
X7R - 10 gigohms or 100 megohm x µF, whichever is less.
Z5U - 1 gigohm or 100 megohm x µF, whichever is less.

Moisture Resistance:

EIA RS-198D, Method 204, Condition A (10 cycles without applied voltage).

Post-Test Limits at + 25°C are:

Capacitance Change:

C0G - 3%, or 0.25 pF, whichever is greater.
X7R - ± 20% of initial value. ⁽²⁾
Z5U - ± 30% of initial value. ⁽²⁾

Dissipation Factor:

C0G - 0.25% maximum
X7R - 3.0% maximum
Z5U - 4.0% maximum

Insulation Resistance:

C0G - 10 gigohms or 100 megohm x µF, whichever is less.
X7R - 10 gigohms or 100 megohm x µF, whichever is less.
Z5U - 1 gigohm or 100 megohm x µF, whichever is less.

Thermal Shock:

EIA RS-198D, Method 202, Condition B (C0G & X7R: - 55°C to + 125°C; Z5U: - 55°C to + 85°C)

- (1) +53 ppm -30 ppm/°C from + 25°C to - 55°C, ± 60 ppm below 10 pF.
- (2) X7R & Z5U dielectrics exhibit aging characteristics; therefore, it is highly recommended that capacitors be deaged for 2 hours at 150°C and stabilized at room temperature for 48 hours before capacitance measurements are made.

CAPACITANCE OUTLINE DRAWING

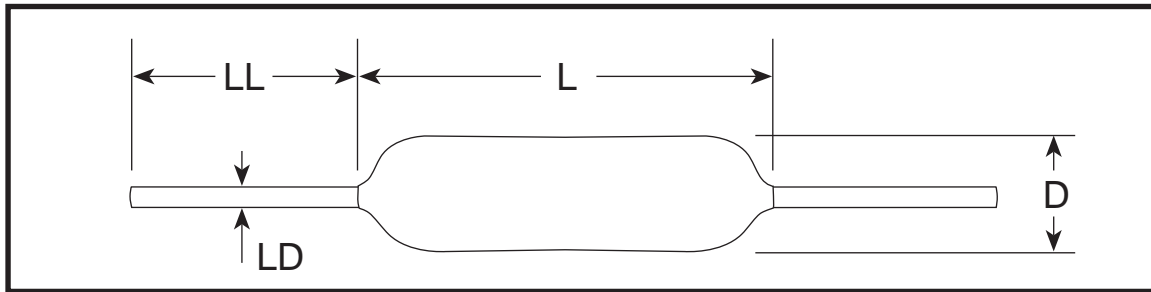

MAXIMUM DIMENSIONS—INCHES & (MILLIMETERS)

| STYLE | L MAX | D MAX | LD +.001, -.003 (+.025, -.076) | LL MIN |
|-------|--------------|-------------|--------------------------------------|------------|
| C410 | .170 (4.32) | .100 (2.54) | .020 (.51) | 1.0 (25.4) |
| C412 | .170 (4.32) | .120 (3.05) | .020 (.51) | 1.0 (25.4) |
| C420 | .260 (6.60) | .100 (2.54) | .020 (.51) | 1.0 (25.4) |
| C430 | .290 (7.37) | .150 (3.81) | .020 (.51) | 1.0 (25.4) |
| C440 | .400 (10.16) | .150 (3.81) | .020 (.51) | 1.0 (25.4) |

ORDERING INFORMATION

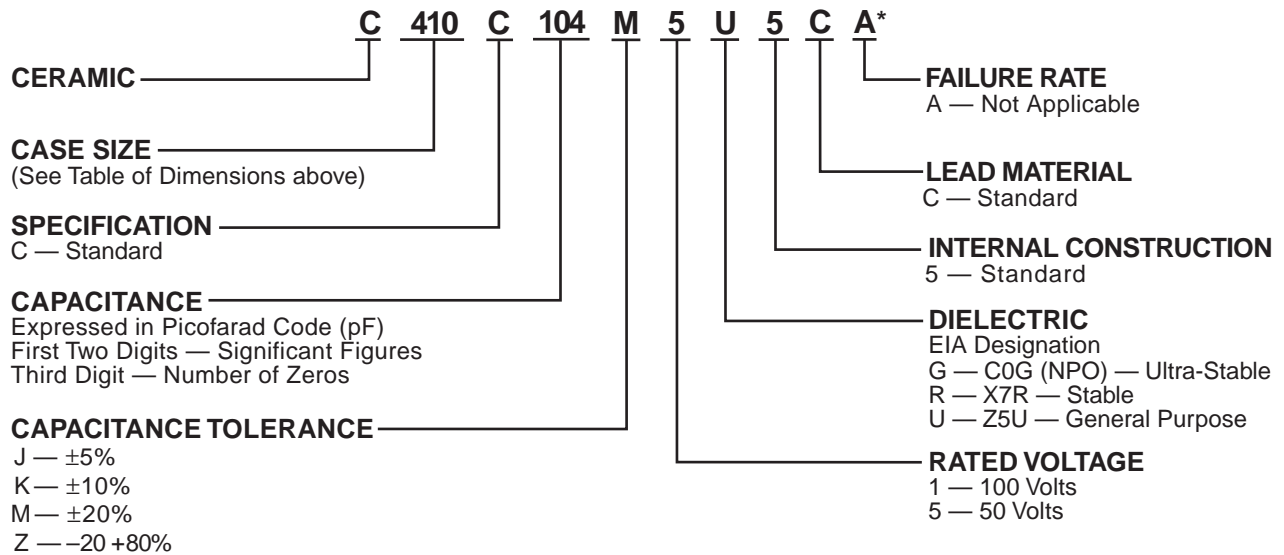

***Part Number Example: C410C104M5U5CA (14 digits – no spaces)**

MARKING INFORMATION

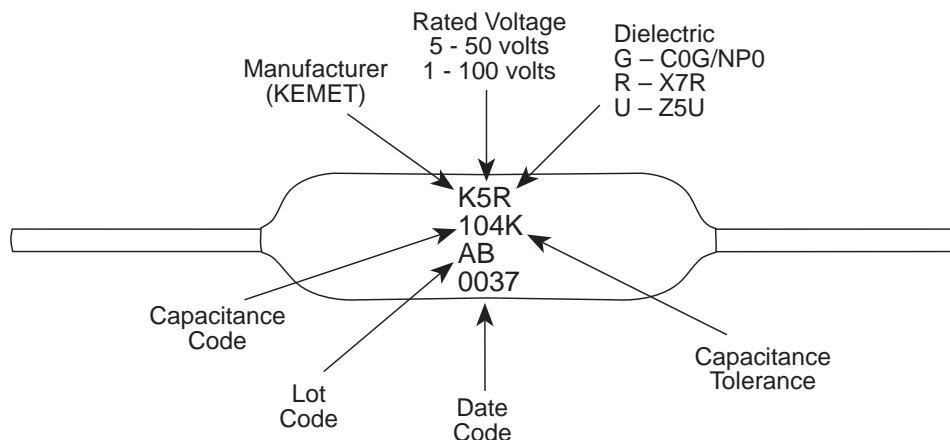

RATINGS & PART NUMBER REFERENCE

ULTRA-STABLE
TEMPERATURE
CHARACTERISTIC — C0G/NP0

| CAPACITANCE pF | KEMET PART NUMBER |
|-----------------------|----------------------|
| 100 VOLT - C0G | |
| 10 | C410C100(1)1G5CA |
| 12 | C410C120(1)1G5CA |
| 15 | C410C150(1)1G5CA |
| 18 | C410C180(1)1G5CA |
| 22 | C410C220(1)1G5CA |
| 27 | C410C270(1)1G5CA |
| 33 | C410C330(1)1G5CA |
| 39 | C410C390(1)1G5CA |
| 47 | C410C470(1)1G5CA |
| 56 | C410C560(1)1G5CA |
| 68 | C410C680(1)1G5CA |
| 82 | C410C820(1)1G5CA |
| 100 | C410C101(1)1G5CA |
| 120 | C410C121(1)1G5CA |
| 150 | C410C151(1)1G5CA |
| 180 | C410C181(1)1G5CA |
| 220 | C410C221(1)1G5CA |
| 270 | C410C271(1)1G5CA |
| 330 | C410C331(1)1G5CA |
| 390 | C410C391(1)1G5CA |
| 470 | C410C471(1)1G5CA |
| 560 | C410C561(1)1G5CA |
| 680 | C410C681(1)1G5CA |
| 820 | C410C821(1)1G5CA |
| 1,000 | C410C102(1)1G5CA |
| 1,200 | C420C122(1)1G5CA |
| 1,500 | C420C152(1)1G5CA |
| 1,800 | C420C182(1)1G5CA |
| 2,200 | C420C222(1)1G5CA |
| 2,700 | C430C272(1)1G5CA |
| 3,300 | C430C332(1)1G5CA |
| 3,900 | C430C392(1)1G5CA |
| 4,700 | C430C472(1)1G5CA |
| 5,600 | C430C562(1)1G5CA |
| 6,800 | C430C682(1)1G5CA |
| 8,200 | C430C822(1)1G5CA |
| 10,000 | C440C103(1)1G5CA |
| 12,000 | C440C123(1)1G5CA |
| 15,000 | C440C153(1)1G5CA |
| 50 VOLT - C0G | |
| 560 | C410C561(1)5G5CA |
| 680 | C410C681(1)5G5CA |
| 820 | C410C821(1)5G5CA |
| 1,000 | C410C102(1)5G5CA |
| 1,200 | C412C122(1)5G5CA |
| 1,500 | C412C152(1)5G5CA |
| 1,800 | C412C182(1)5G5CA |
| 2,200 | C412C222(1)5G5CA |
| 2,700 | C412C272(1)5G5CA |
| 1,200 | C420C122(1)5G5CA |
| 1,500 | C420C152(1)5G5CA |
| 1,800 | C420C182(1)5G5CA |
| 2,200 | C420C222(1)5G5CA |
| 2,700 | C430C272(1)5G5CA |
| 3,300 | C430C332(1)5G5CA |
| 3,900 | C430C392(1)5G5CA |
| 4,700 | C430C472(1)5G5CA |
| 5,600 | C430C562(1)5G5CA |
| 6,800 | C430C682(1)5G5CA |
| 8,200 | C430C822(1)5G5CA |
| 10,000 | C440C103(1)5G5CA |
| 12,000 | C440C123(1)5G5CA |
| 15,000 | C440C153(1)5G5CA |

SINGLE
TEMPERATURE
CHARACTERISTIC — X7R

| CAPACITANCE pF | KEMET PART NUMBER |
|-----------------------|----------------------|
| 100 VOLT - X7R | |
| 470 | C410C471(1)1R5CA |
| 560 | C410C561(1)1R5CA |
| 680 | C410C681(1)1R5CA |
| 820 | C410C821(1)1R5CA |
| 1,000 | C410C102(1)1R5CA |
| 1,200 | C410C122(1)1R5CA |
| 1,500 | C410C152(1)1R5CA |
| 1,800 | C410C182(1)1R5CA |
| 2,200 | C410C222(1)1R5CA |
| 2,700 | C410C272(1)1R5CA |
| 3,300 | C410C332(1)1R5CA |
| 3,900 | C410C392(1)1R5CA |
| 4,700 | C410C472(1)1R5CA |
| 5,600 | C410C562(1)1R5CA |
| 6,800 | C410C682(1)1R5CA |
| 8,200 | C410C822(1)1R5CA |
| 10,000 | C410C103(1)1R5CA |
| 12,000 | C410C123(1)1R5CA |
| 15,000 | C412C153(1)1R5CA |
| 18,000 | C412C183(1)1R5CA |
| 22,000 | C412C223(1)1R5CA |
| 27,000 | C412C273(1)1R5CA |
| 15,000 | C420C153(1)1R5CA |
| 18,000 | C420C183(1)1R5CA |
| 22,000 | C420C223(1)1R5CA |
| 27,000 | C420C273(1)1R5CA |
| 39,000 | C430C393(1)1R5CA |
| 47,000 | C430C473(1)1R5CA |
| 56,000 | C430C563(1)1R5CA |
| 68,000 | C430C683(1)1R5CA |
| 82,000 | C430C823(1)1R5CA |
| 100,000 | C430C104(1)1R5CA |
| 120,000 | C440C124(1)1R5CA |
| 150,000 | C440C154(1)1R5CA |
| 50 VOLT - X7R | |
| 8,200 | C410C822(1)5R5CA |
| 10,000 | C410C103(1)5R5CA |
| 12,000 | C410C123(1)5R5CA |
| 15,000 | C410C153(1)5R5CA |
| 18,000 | C410C183(1)5R5CA |
| 22,000 | C410C223(1)5R5CA |
| 27,000 | C410C273(1)5R5CA |
| 33,000 | C410C333(1)5R5CA |
| 39,000 | C410C393(1)5R5CA |
| 47,000 | C410C473(1)5R5CA |
| 56,000 | C412C563(1)5R5CA |
| 68,000 | C412C683(1)5R5CA |
| 82,000 | C412C823(1)5R5CA |
| 100,000 | C412C104(1)5R5CA |
| 56,000 | C420C563(1)5R5CA |
| 68,000 | C420C683(1)5R5CA |
| 82,000 | C420C823(1)5R5CA |
| 100,000 | C420C104(1)5R5CA |
| 120,000 | C430C124(1)5R5CA |
| 150,000 | C430C154(1)5R5CA |
| 180,000 | C430C184(1)5R5CA |
| 220,000 | C430C224(1)5R5CA |
| 270,000 | C430C274(1)5R5CA |
| 330,000 | C440C334(1)5R5CA |
| 390,000 | C440C394(1)5R5CA |
| 470,000 | C440C474(1)5R5CA |

GENERAL PURPOSE
TEMPERATURE
CHARACTERISTIC — Z5U

| CAPACITANCE pF | KEMET PART NUMBER |
|-----------------------|----------------------|
| 100 VOLT - Z5U | |
| 10,000 | C410C103(1)1U5CA |
| 12,000 | C410C123(1)1U5CA |
| 15,000 | C410C153(1)1U5CA |
| 18,000 | C410C183(1)1U5CA |
| 22,000 | C410C223(1)1U5CA |
| 27,000 | C420C273(1)1U5CA |
| 33,000 | C420C333(1)1U5CA |
| 39,000 | C420C393(1)1U5CA |
| 47,000 | C420C473(1)1U5CA |
| 56,000 | C430C563(1)1U5CA |
| 68,000 | C430C683(1)1U5CA |
| 82,000 | C430C823(1)1U5CA |
| 100,000 | C430C104(1)1U5CA |
| 120,000 | C430C124(1)1U5CA |
| 150,000 | C430C154(1)1U5CA |
| 180,000 | C440C184(1)1U5CA |
| 220,000 | C440C224(1)1U5CA |
| 50 VOLT - Z5U | |
| 27,000 | C410C273(1)5U5CA |
| 33,000 | C410C333(1)5U5CA |
| 39,000 | C410C393(1)5U5CA |
| 47,000 | C410C473(1)5U5CA |
| 56,000 | C410C563(1)5U5CA |
| 68,000 | C410C683(1)5U5CA |
| 82,000 | C410C823(1)5U5CA |
| 100,000 | C410C104(1)5U5CA |
| 120,000 | C410C124(1)5U5CA |
| 150,000 | C410C154(1)5U5CA |
| 180,000 | C410C184(1)5U5CA |
| 220,000 | C410C224(1)5U5CA |
| 270,000 | C412C274(1)5U5CA |
| 330,000 | C412C334(1)5U5CA |
| 270,000 | C420C274(1)5U5CA |
| 330,000 | C420C334(1)5U5CA |
| 390,000 | C430C394(1)5U5CA |
| 470,000 | C430C474(1)5U5CA |
| 560,000 | C430C564(1)5U5CA |
| 680,000 | C430C684(1)5U5CA |
| 820,000 | C440C824(1)5U5CA |
| 1,000,000 | C440C105(1)5U5CA |

(1) Insert proper letter for capacitance tolerance desired:
M = ±20%, Z = +80, -20%

(1) Insert proper letter for capacitance tolerance desired:
J = ±5%
K = ±10%
M = ±20%

(1) Insert proper letter for capacitance tolerance desired:
K = ±10%, M = ±20%

For packaging information, see pages 32 and 34.

STANDARD LEAD CONFIGURATION — OUTLINE DRAWINGS

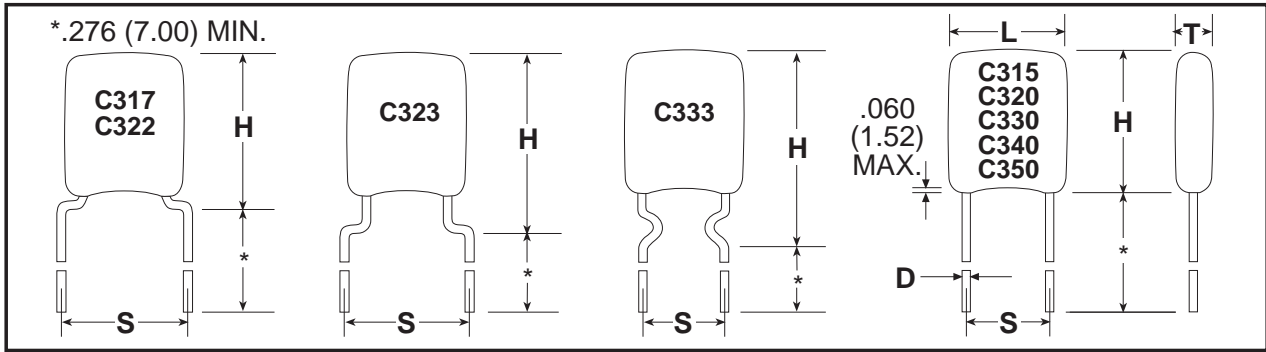

Drawings are not to scale. See table below for dimensions.
See page 9 for optional lead configurations.

DIMENSIONS — INCHES & MILLIMETERS

| CASE SIZE | L MAX. | H MAX. | T MAX. | S(1) ±.030 | D +.004 - .001 |
|-----------|--------------|--------------|-------------|--------------|----------------|
| C315 | .150 (3.81) | .210 (5.33) | .100 (2.54) | .100 (2.54) | .020 (.51) |
| C317 | .150 (3.81) | .230 (5.84) | .100 (2.54) | .200 (5.08) | .020 (.51) |
| C320 | .200 (5.08) | .260 (6.60) | .125 (3.18) | .100 (2.54) | .020 (.51) |
| C322 | .200 (5.08) | .260 (6.60) | .125 (3.18) | .200 (5.08) | .020 (.51) |
| C323 | .200 (5.08) | .320 (8.13) | .125 (3.18) | .200 (5.08) | .020 (.51) |
| C330 | .300 (7.62) | .360 (9.14) | .150 (3.81) | .200 (5.08) | .020 (.51) |
| C333 | .300 (7.62) | .390 (9.91) | .150 (3.81) | .200 (5.08) | .020 (.51) |
| C340 | .400 (10.16) | .460 (11.68) | .150 (3.81) | .200 (5.08) | .020 (.51) |
| C350 | .500 (12.70) | .560 (14.22) | .200 (5.08) | .400 (10.16) | .025 (.64) |

NOTE: 1 inch = 25.4 mm.
NOTE: (1) Measured at seating plane.

ORDERING INFORMATION

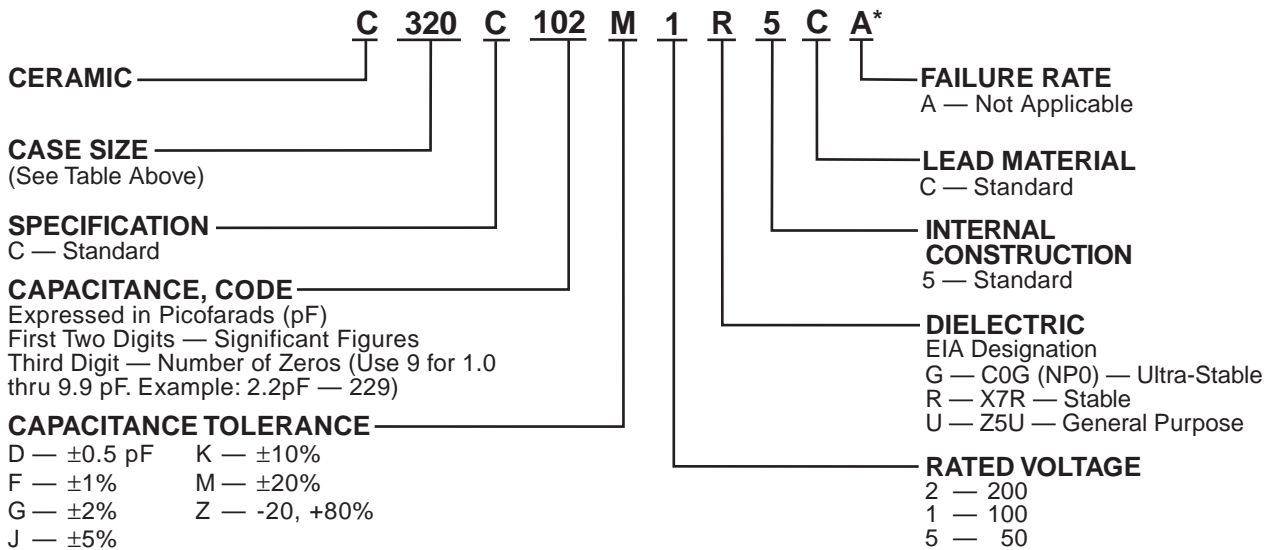

*Part Number Example: **C320C102M1R5CA** (14 digits – no spaces)

For packaging information, see pages 33 and 34.

OPTIONAL CONFIGURATIONS BY LEAD SPACING

The preferred lead wire configurations are shown on page 8. However, additional configurations are available. All available options, including those on page 8, are shown below grouped by lead spacing.

| | | | | | | |
|------------------------------|-----------|-----------|------------------------------|-----------|-----------|-----------|
| Lead Spacing .100" ± .030 | C 315 | C 316 | C 320 | C 324 | C 326 | |
| | C 317 | C 318 | C 322 | C 323 | | |
| Lead Spacing .200" ± .030 | C 325 | C 327 | C 328 | | | |
| | C 330 | C 333 | C 335 | C 336 | C 340 | C 346 |
| Lead Spacing .250" ± .030 | C 321 | C 331 | Lead Spacing .400" ± .030 | | C 350 | C 356 |

CAPACITOR MARKINGS

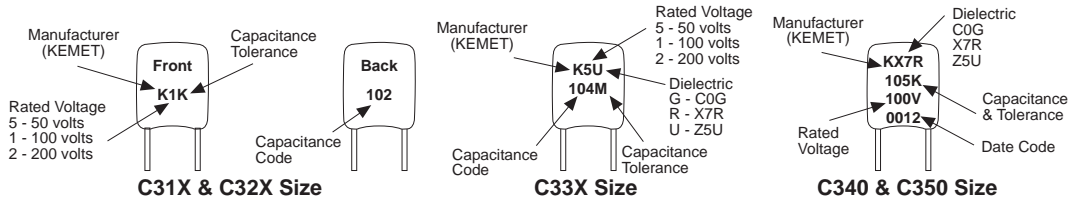

RATINGS & PART NUMBER REFERENCE: ULTRA-STABLE TEMPERATURE CHARACTERISTICS – C0G

| CAPACITANCE | KEMET PART NUMBER |
|-----------------------------|--------------------|
| 200 VOLT – C31X SIZE | |
| 1.0 pF | C31(1)C109(3)2G5CA |
| 1.5 pF | C31(1)C159(3)2G5CA |
| 2.2 pF | C31(1)C229(3)2G5CA |
| 2.7 pF | C31(1)C279(3)2G5CA |
| 3.3 pF | C31(1)C339(3)2G5CA |
| 3.9 pF | C31(1)C399(3)2G5CA |
| 4.7 pF | C31(1)C479(3)2G5CA |
| 5.6 pF | C31(1)C569(3)2G5CA |
| 6.8 pF | C31(1)C689(3)2G5CA |
| 8.2 pF | C31(1)C829(3)2G5CA |
| 10 pF | C31(1)C100(3)2G5CA |
| 12 pF | C31(1)C120(3)2G5CA |
| 15 pF | C31(1)C150(3)2G5CA |
| 18 pF | C31(1)C180(3)2G5CA |
| 22 pF | C31(1)C220(3)2G5CA |
| 27 pF | C31(1)C270(3)2G5CA |
| 33 pF | C31(1)C330(3)2G5CA |
| 39 pF | C31(1)C390(3)2G5CA |
| 47 pF | C31(1)C470(3)2G5CA |
| 56 pF | C31(1)C560(3)2G5CA |
| 68 pF | C31(1)C680(3)2G5CA |
| 82 pF | C31(1)C820(3)2G5CA |
| 100 pF | C31(1)C101(3)2G5CA |
| 120 pF | C31(1)C121(3)2G5CA |
| 150 pF | C31(1)C151(3)2G5CA |
| 180 pF | C31(1)C181(3)2G5CA |
| 220 pF | C31(1)C221(3)2G5CA |
| 270 pF | C31(1)C271(3)2G5CA |
| 330 pF | C31(1)C331(3)2G5CA |
| 390 pF | C31(1)C391(3)2G5CA |
| 470 pF | C31(1)C471(3)2G5CA |
| 200 VOLT – C32X SIZE | |
| 1.0 pF | C32(2)C109(3)2G5CA |
| 1.5 pF | C32(2)C159(3)2G5CA |
| 2.2 pF | C32(2)C229(3)2G5CA |
| 2.7 pF | C32(2)C279(3)2G5CA |
| 3.3 pF | C32(2)C339(3)2G5CA |
| 3.9 pF | C32(2)C399(3)2G5CA |
| 4.7 pF | C32(2)C479(3)2G5CA |
| 5.6 pF | C32(2)C569(3)2G5CA |
| 6.8 pF | C32(2)C689(3)2G5CA |
| 8.2 pF | C32(2)C829(3)2G5CA |
| 10 pF | C32(2)C100(3)2G5CA |
| 12 pF | C32(2)C120(3)2G5CA |
| 15 pF | C32(2)C150(3)2G5CA |
| 18 pF | C32(2)C180(3)2G5CA |
| 22 pF | C32(2)C220(3)2G5CA |
| 27 pF | C32(2)C270(3)2G5CA |
| 33 pF | C32(2)C330(3)2G5CA |
| 39 pF | C32(2)C390(3)2G5CA |

| CAPACITANCE | KEMET PART NUMBER |
|--------------------------------------|--------------------|
| 200 VOLT – C32X SIZE (Cont'd) | |
| 47 pF | C32(2)C470(3)2G5CA |
| 56 pF | C32(2)C560(3)2G5CA |
| 68 pF | C32(2)C680(3)2G5CA |
| 82 pF | C32(2)C820(3)2G5CA |
| 100 pF | C32(2)C101(3)2G5CA |
| 120 pF | C32(2)C121(3)2G5CA |
| 150 pF | C32(2)C151(3)2G5CA |
| 180 pF | C32(2)C181(3)2G5CA |
| 220 pF | C32(2)C221(3)2G5CA |
| 270 pF | C32(2)C271(3)2G5CA |
| 330 pF | C32(2)C331(3)2G5CA |
| 390 pF | C32(2)C391(3)2G5CA |
| 470 pF | C32(2)C471(3)2G5CA |
| 560 pF | C32(2)C561(3)2G5CA |
| 680 pF | C32(2)C681(3)2G5CA |
| 820 pF | C32(2)C821(3)2G5CA |
| 1,000 pF | C32(2)C102(3)2G5CA |
| 1,200 pF | C32(2)C122(3)2G5CA |
| 1,500 pF | C32(2)C152(3)2G5CA |
| 1,800 pF | C32(2)C182(3)2G5CA |
| 2,200 pF | C32(2)C222(3)2G5CA |
| 2,700 pF | C32(2)C272(3)2G5CA |
| 3,300 pF | C32(2)C332(3)2G5CA |
| 200 VOLT – C33X SIZE | |
| 2,700 pF | C33(4)C272(3)2G5CA |
| 3,300 pF | C33(4)C332(3)2G5CA |
| 3,900 pF | C33(4)C392(3)2G5CA |
| 4,700 pF | C33(4)C472(3)2G5CA |
| 5,600 pF | C33(4)C562(3)2G5CA |
| 6,800 pF | C33(4)C682(3)2G5CA |
| 8,200 pF | C33(4)C822(3)2G5CA |
| .01 µF | C33(4)C103(3)2G5CA |
| .012 µF | C33(4)C123(3)2G5CA |
| .015 µF | C33(4)C153(3)2G5CA |
| .018 µF | C33(4)C183(3)2G5CA |
| 200 VOLT – C340 SIZE | |
| .018 µF | C340C183(3)2G5CA |
| .022 µF | C340C223(3)2G5CA |
| .027 µF | C340C273(3)2G5CA |
| .033 µF | C340C333(3)2G5CA |
| .039 µF | C340C393(3)2G5CA |
| .047 µF | C340C473(3)2G5CA |
| 200 VOLT – C350 SIZE | |
| .039 µF | C350C393(3)2G5CA |
| .047 µF | C350C473(3)2G5CA |
| .056 µF | C350C563(3)2G5CA |
| .068 µF | C350C683(3)2G5CA |

| CAPACITANCE | KEMET PART NUMBER |
|-----------------------------|--------------------|
| 100 VOLT – C31X SIZE | |
| 120 pF | C31(1)C121(3)1G5CA |
| 150 pF | C31(1)C151(3)1G5CA |
| 180 pF | C31(1)C181(3)1G5CA |
| 220 pF | C31(1)C221(3)1G5CA |
| 270 pF | C31(1)C271(3)1G5CA |
| 330 pF | C31(1)C331(3)1G5CA |
| 390 pF | C31(1)C391(3)1G5CA |
| 470 pF | C31(1)C471(3)1G5CA |
| 560 pF | C31(1)C561(3)1G5CA |
| 680 pF | C31(1)C681(3)1G5CA |
| 820 pF | C31(1)C821(3)1G5CA |
| 1,000 pF | C31(1)C102(3)1G5CA |
| 100 VOLT – C32X SIZE | |
| 680 pF | C32(2)C681(3)1G5CA |
| 820 pF | C32(2)C821(3)1G5CA |
| 1,000 pF | C32(2)C102(3)1G5CA |
| 1,200 pF | C32(2)C122(3)1G5CA |
| 1,500 pF | C32(2)C152(3)1G5CA |
| 1,800 pF | C32(2)C182(3)1G5CA |
| 2,200 pF | C32(2)C222(3)1G5CA |
| 2,700 pF | C32(2)C272(3)1G5CA |
| 3,300 pF | C32(2)C332(3)1G5CA |
| 3,900 pF | C32(2)C392(3)1G5CA |
| 4,700 pF | C32(2)C472(3)1G5CA |
| 5,600 pF | C32(2)C562(3)1G5CA |
| 100 VOLT – C33X SIZE | |
| 3,300 pF | C33(4)C332(3)1G5CA |
| 3,900 pF | C33(4)C392(3)1G5CA |
| 4,700 pF | C33(4)C472(3)1G5CA |
| 5,600 pF | C33(4)C562(3)1G5CA |
| 6,800 pF | C33(4)C682(3)1G5CA |
| 8,200 pF | C33(4)C822(3)1G5CA |
| .01 µF | C33(4)C103(3)1G5CA |
| .012 µF | C33(4)C123(3)1G5CA |
| .015 µF | C33(4)C153(3)1G5CA |
| .018 µF | C33(4)C183(3)1G5CA |
| .022 µF | C33(4)C223(3)1G5CA |
| .027 µF | C33(4)C273(3)1G5CA |
| 100 VOLT – C340 SIZE | |
| .027 µF | C340C273(3)1G5CA |
| .033 µF | C340C333(3)1G5CA |
| .039 µF | C340C393(3)1G5CA |
| .047 µF | C340C473(3)1G5CA |
| .056 µF | C340C563(3)1G5CA |
| .068 µF | C340C683(3)1G5CA |
| 100 VOLT – C350 SIZE | |
| .039 µF | C350C393(3)1G5CA |
| .047 µF | C350C473(3)1G5CA |
| .056 µF | C350C563(3)1G5CA |
| .068 µF | C350C683(3)1G5CA |
| .082 µF | C350C823(3)1G5CA |
| .1 µF | C350C104(3)1G5CA |
| .12 µF | C350C124(3)1G5CA |

NOTES: (1) Case Sizes C315/C317 are identical electrically, but differ in lead spacing. See table of dimensions. Insert the appropriate symbol, "5" or "7" in the part number.
 (2) Case Sizes C320/C322/C323 are identical electrically. See table of dimensions. Insert the appropriate symbol, "0" or "2" or "3" in the part number.
 (3) Insert proper symbol for capacitance tolerance as follows:
 1.0 pF – 8.2 pF: D – ± 0.5pF
 10 pF – 22 pF: J – ±5%, K – ±10%
 27 pF – 47 pF: G – ±2%, J – ±5%, K – ±10%
 56 pF and up: F – ±1%, G – ±2%, J – ±5%
 (4) Case Sizes C330 and C333 are identical electrically. Insert the appropriate symbol "0" or "3" in the part number.

RATINGS & PART NUMBER REFERENCE: STABLE TEMPERATURE CHARACTERISTICS – X7R

| CAPACITANCE | KEMET PART NUMBER |
|-----------------------------|--------------------|
| 200 VOLT – C31X SIZE | |
| 100 pF | C31(1)C101(3)2R5CA |
| 120 pF | C31(1)C121(3)2R5CA |
| 150 pF | C31(1)C151(3)2R5CA |
| 180 pF | C31(1)C181(3)2R5CA |
| 220 pF | C31(1)C221(3)2R5CA |
| 270 pF | C31(1)C271(3)2R5CA |
| 330 pF | C31(1)C331(3)2R5CA |
| 390 pF | C31(1)C391(3)2R5CA |
| 470 pF | C31(1)C471(3)2R5CA |
| 560 pF | C31(1)C561(3)2R5CA |
| 680 pF | C31(1)C681(3)2R5CA |
| 820 pF | C31(1)C821(3)2R5CA |
| 1,000 pF | C31(1)C102(3)2R5CA |
| 1,200 pF | C31(1)C122(3)2R5CA |
| 1,500 pF | C31(1)C152(3)2R5CA |
| 1,800 pF | C31(1)C182(3)2R5CA |
| 2,200 pF | C31(1)C222(3)2R5CA |
| 200 VOLT – C32X SIZE | |
| 1,000 pF | C32(2)C102(3)2R5CA |
| 1,200 pF | C32(2)C122(3)2R5CA |
| 1,500 pF | C32(2)C152(3)2R5CA |
| 1,800 pF | C32(2)C182(3)2R5CA |
| 2,200 pF | C32(2)C222(3)2R5CA |
| 2,700 pF | C32(2)C272(3)2R5CA |
| 3,300 pF | C32(2)C332(3)2R5CA |
| 3,900 pF | C32(2)C392(3)2R5CA |
| 4,700 pF | C32(2)C472(3)2R5CA |
| 5,600 pF | C32(2)C562(3)2R5CA |
| 6,800 pF | C32(2)C682(3)2R5CA |
| 8,200 pF | C32(2)C822(3)2R5CA |
| .01 µF | C32(2)C103(3)2R5CA |
| .012 µF | C32(2)C123(3)2R5CA |
| .015 µF | C32(2)C153(3)2R5CA |
| .018 µF | C32(2)C183(3)2R5CA |
| .022 µF | C32(2)C223(3)2R5CA |
| 200 VOLT – C33X SIZE | |
| .015 µF | C33(4)C153(3)2R5CA |
| .018 µF | C33(4)C183(3)2R5CA |
| .022 µF | C33(4)C223(3)2R5CA |
| .027 µF | C33(4)C273(3)2R5CA |
| .033 µF | C33(4)C333(3)2R5CA |
| .039 µF | C33(4)C393(3)2R5CA |
| .047 µF | C33(4)C473(3)2R5CA |
| .056 µF | C33(4)C563(3)2R5CA |
| .068 µF | C33(4)C683(3)2R5CA |
| .082 µF | C33(4)C823(3)2R5CA |
| .1 µF | C33(4)C104(3)2R5CA |
| 200 VOLT – C340 SIZE | |
| .1 µF | C340C104(3)2R5CA |
| .12 µF | C340C124(3)2R5CA |
| .15 µF | C340C154(3)2R5CA |
| .18 µF | C340C184(3)2R5CA |
| .22 µF | C340C224(3)2R5CA |
| .27 µF | C340C274(3)2R5CA |
| 200 VOLT – C350 SIZE | |
| .22 µF | C350C224(3)2R5CA |
| .27 µF | C350C274(3)2R5CA |
| .33 µF | C350C334(3)2R5CA |
| .39 µF | C350C394(3)2R5CA |
| .47 µF | C350C474(3)2R5CA |

| CAPACITANCE | KEMET PART NUMBER |
|-----------------------------|--------------------|
| 100 VOLT – C31X SIZE | |
| 820 pF | C31(1)C821(3)1R5CA |
| 1,000 pF | C31(1)C102(3)1R5CA |
| 1,200 pF | C31(1)C122(3)1R5CA |
| 1,500 pF | C31(1)C152(3)1R5CA |
| 1,800 pF | C31(1)C182(3)1R5CA |
| 2,200 pF | C31(1)C222(3)1R5CA |
| 2,700 pF | C31(1)C272(3)1R5CA |
| 3,300 pF | C31(1)C332(3)1R5CA |
| 3,900 pF | C31(1)C392(3)1R5CA |
| 4,700 pF | C31(1)C472(3)1R5CA |
| 5,600 pF | C31(1)C562(3)1R5CA |
| 6,800 pF | C31(1)C682(3)1R5CA |
| 8,200 pF | C31(1)C822(3)1R5CA |
| .01 µF | C31(1)C103(3)1R5CA |
| 100 VOLT – C32X SIZE | |
| 4,700 pF | C32(2)C472(3)1R5CA |
| 5,600 pF | C32(2)C562(3)1R5CA |
| 6,800 pF | C32(2)C682(3)1R5CA |
| 8,200 pF | C32(2)C822(3)1R5CA |
| .01 µF | C32(2)C103(3)1R5CA |
| .012 µF | C32(2)C123(3)1R5CA |
| .015 µF | C32(2)C153(3)1R5CA |
| .018 µF | C32(2)C183(3)1R5CA |
| .022 µF | C32(2)C223(3)1R5CA |
| .027 µF | C32(2)C273(3)1R5CA |
| .033 µF | C32(2)C333(3)1R5CA |
| .039 µF | C32(2)C393(3)1R5CA |
| .047 µF | C32(2)C473(3)1R5CA |
| .056 µF | C32(2)C563(3)1R5CA |
| .068 µF | C32(2)C683(3)1R5CA |
| .082 µF | C32(2)C823(3)1R5CA |
| .1 µF | C32(2)C104(3)1R5CA |
| 100 VOLT – C33X SIZE | |
| .068 µF | C33(4)C683(3)1R5CA |
| .082 µF | C33(4)C823(3)1R5CA |
| .1 µF | C33(4)C104(3)1R5CA |
| .12 µF | C33(4)C124(3)1R5CA |
| .15 µF | C33(4)C154(3)1R5CA |
| .18 µF | C33(4)C184(3)1R5CA |
| .22 µF | C33(4)C224(3)1R5CA |
| .27 µF | C33(4)C274(3)1R5CA |
| .33 µF | C33(4)C334(3)1R5CA |
| .39 µF | C33(4)C394(3)1R5CA |
| .47 µF | C33(4)C474(3)1R5CA |
| 100 VOLT – C340 SIZE | |
| .47 µF | C340C474(3)1R5CA |
| .56 µF | C340C564(3)1R5CA |
| .68 µF | C340C684(3)1R5CA |
| .82 µF | C340C824(3)1R5CA |
| 1.0 µF | C340C105(3)1R5CA |
| 100 VOLT – C350 SIZE | |
| .68 µF | C350C684(3)1R5CA |
| .82 µF | C350C824(3)1R5CA |
| 1.0 µF | C350C105(3)1R5CA |
| 1.2 µF | C350C125(3)1R5CA |

| CAPACITANCE | KEMET PART NUMBER |
|----------------------------|--------------------|
| 50 VOLT – C31X SIZE | |
| 3,300 pF | C31(1)C332(3)5R5CA |
| 3,900 pF | C31(1)C392(3)5R5CA |
| 4,700 pF | C31(1)C472(3)5R5CA |
| 5,600 pF | C31(1)C562(3)5R5CA |
| 6,800 pF | C31(1)C682(3)5R5CA |
| 8,200 pF | C31(1)C822(3)5R5CA |
| .01 µF | C31(1)C103(3)5R5CA |
| .012 µF | C31(1)C123(3)5R5CA |
| .015 µF | C31(1)C153(3)5R5CA |
| .018 µF | C31(1)C183(3)5R5CA |
| .022 µF | C31(1)C223(3)5R5CA |
| .027 µF | C31(1)C273(3)5R5CA |
| .033 µF | C31(1)C333(3)5R5CA |
| 50 VOLT – C32X SIZE | |
| .012 µF | C32(2)C123(3)5R5CA |
| .015 µF | C32(2)C153(3)5R5CA |
| .018 µF | C32(2)C183(3)5R5CA |
| .022 µF | C32(2)C223(3)5R5CA |
| .027 µF | C32(2)C273(3)5R5CA |
| .033 µF | C32(2)C333(3)5R5CA |
| .039 µF | C32(2)C393(3)5R5CA |
| .047 µF | C32(2)C473(3)5R5CA |
| .056 µF | C32(2)C563(3)5R5CA |
| .068 µF | C32(2)C683(3)5R5CA |
| .082 µF | C32(2)C823(3)5R5CA |
| .1 µF | C32(2)C104(3)5R5CA |
| .12 µF | C32(2)C124(3)5R5CA |
| .15 µF | C32(2)C154(3)5R5CA |
| .18 µF | C32(2)C184(3)5R5CA |
| .22 µF | C32(2)C224(3)5R5CA |
| .27 µF | C32(2)C274(3)5R5CA |
| 50 VOLT – C33X SIZE | |
| .15 µF | C33(4)C154(3)5R5CA |
| .18 µF | C33(4)C184(3)5R5CA |
| .22 µF | C33(4)C224(3)5R5CA |
| .27 µF | C33(4)C274(3)5R5CA |
| .33 µF | C33(4)C334(3)5R5CA |
| .39 µF | C33(4)C394(3)5R5CA |
| .47 µF | C33(4)C474(3)5R5CA |
| .56 µF | C33(4)C564(3)5R5CA |
| .68 µF | C33(4)C684(3)5R5CA |
| .82 µF | C33(4)C824(3)5R5CA |
| 1.0 µF | C33(4)C105(3)5R5CA |
| 50 VOLT – C340 SIZE | |
| 1.2 µF | C340C125(3)5R5CA |
| 1.5 µF | C340C155(3)5R5CA |
| 1.8 µF | C340C185(3)5R5CA |
| 2.2 µF | C340C225(3)5R5CA |
| 50 VOLT – C350 SIZE | |
| 2.2 µF | C350C225(3)5R5CA |
| 2.7 µF | C350C275(3)5R5CA |
| 3.3 µF | C350C335(3)5R5CA |
| 3.9 µF | C350C395(3)5R5CA |
| 4.7 µF | C350C475(3)5R5CA |

Golden Max

NOTES: (1) Case Sizes C315/C317 are identical electrically, but differ in lead spacing. See table of dimensions. Insert the appropriate symbol, "5" or "7" in the part number.
 (2) Case Sizes C320/C322/C323 are identical electrically. See table of dimensions. Insert the appropriate symbol, "0" or "2" or "3" in the part number.
 (3) Insert proper symbol for capacitance tolerance as follows: K – ±10%, M – ±20%
 (4) Case Sizes C330 and C333 are identical electrically. Insert the appropriate symbol "0" or "3" in the part number.

RATINGS & PART NUMBER REFERENCE
GENERAL PURPOSE TEMPERATURE CHARACTERISTIC – Z5U

| CAPACITANCE | KEMET PART NUMBER |
|-----------------------------|--------------------|
| 100 VOLT – C31X SIZE | |
| 1,000 pF | C31(1)C102(3)1U5CA |
| 1,200 pF | C31(1)C122(3)1U5CA |
| 1,500 pF | C31(1)C152(3)1U5CA |
| 1,800 pF | C31(1)C182(3)1U5CA |
| 2,200 pF | C31(1)C222(3)1U5CA |
| 2,700 pF | C31(1)C272(3)1U5CA |
| 3,300 pF | C31(1)C332(3)1U5CA |
| 3,900 pF | C31(1)C392(3)1U5CA |
| 4,700 pF | C31(1)C472(3)1U5CA |
| 5,600 pF | C31(1)C562(3)1U5CA |
| 6,800 pF | C31(1)C682(3)1U5CA |
| 8,200 pF | C31(1)C822(3)1U5CA |
| .01 µF | C31(1)C103(3)1U5CA |
| .012 µF | C31(1)C123(3)1U5CA |
| .015 µF | C31(1)C153(3)1U5CA |
| .018 µF | C31(1)C183(3)1U5CA |
| 100 VOLT – C32X SIZE | |
| .01 µF | C32(2)C103(3)1U5CA |
| .012 µF | C32(2)C123(3)1U5CA |
| .015 µF | C32(2)C153(3)1U5CA |
| .018 µF | C32(2)C183(3)1U5CA |
| .022 µF | C32(2)C223(3)1U5CA |
| .027 µF | C32(2)C273(3)1U5CA |
| .033 µF | C32(2)C333(3)1U5CA |
| .039 µF | C32(2)C393(3)1U5CA |
| .047 µF | C32(2)C473(3)1U5CA |
| .056 µF | C32(2)C563(3)1U5CA |
| .068 µF | C32(2)C683(3)1U5CA |
| .082 µF | C32(2)C823(3)1U5CA |
| 0.1 µF | C32(2)C104(3)1U5CA |
| .12 µF | C32(2)C124(3)1U5CA |
| .15 µF | C32(2)C154(3)1U5CA |
| 100 VOLT – C33X SIZE | |
| 0.1 µF | C33(4)C104(3)1U5CA |
| .12 µF | C33(4)C124(3)1U5CA |
| .15 µF | C33(4)C154(3)1U5CA |
| .18 µF | C33(4)C184(3)1U5CA |
| .22 µF | C33(4)C224(3)1U5CA |
| .27 µF | C33(4)C274(3)1U5CA |
| .33 µF | C33(4)C334(3)1U5CA |
| .39 µF | C33(4)C394(3)1U5CA |
| .47 µF | C33(4)C474(3)1U5CA |
| 100 VOLT – C340 SIZE | |
| .47 µF | C340C474(3)1U5CA |
| .56 µF | C340C564(3)1U5CA |
| .68 µF | C340C684(3)1U5CA |
| .82 µF | C340C824(3)1U5CA |
| 1.0 µF | C340C105(3)1U5CA |
| 1.2 µF | C340C125(3)1U5CA |
| 1.5 µF | C340C155(3)1U5CA |
| 100 VOLT – C350 SIZE | |
| 1.0 µF | C350C105(3)1U5CA |
| 1.2 µF | C350C125(3)1U5CA |
| 1.5 µF | C350C155(3)1U5CA |
| 1.8 µF | C350C185(3)1U5CA |
| 2.2 µF | C350C225(3)1U5CA |

| CAPACITANCE | KEMET PART NUMBER |
|----------------------------|--------------------|
| 50 VOLT – C31X SIZE | |
| 4,700 pF | C31(1)C472(3)5U5CA |
| 5,600 pF | C31(1)C562(3)5U5CA |
| 6,800 pF | C31(1)C682(3)5U5CA |
| 8,200 pF | C31(1)C822(3)5U5CA |
| .01 µF | C31(1)C103(3)5U5CA |
| .012 µF | C31(1)C123(3)5U5CA |
| .015 µF | C31(1)C153(3)5U5CA |
| .018 µF | C31(1)C183(3)5U5CA |
| .022 µF | C31(1)C223(3)5U5CA |
| .027 µF | C31(1)C273(3)5U5CA |
| .033 µF | C31(1)C333(3)5U5CA |
| .039 µF | C31(1)C393(3)5U5CA |
| .047 µF | C31(1)C473(3)5U5CA |
| .056 µF | C31(1)C563(3)5U5CA |
| .068 µF | C31(1)C683(3)5U5CA |
| .082 µF | C31(1)C823(3)5U5CA |
| 0.1 µF | C31(1)C104(3)5U5CA |
| 50 VOLT – C32X SIZE | |
| .027 µF | C32(2)C273(3)5U5CA |
| .033 µF | C32(2)C333(3)5U5CA |
| .039 µF | C32(2)C393(3)5U5CA |
| .047 µF | C32(2)C473(3)5U5CA |
| .056 µF | C32(2)C563(3)5U5CA |
| .068 µF | C32(2)C683(3)5U5CA |
| .082 µF | C32(2)C823(3)5U5CA |
| 0.1 µF | C32(2)C104(3)5U5CA |
| .12 µF | C32(2)C124(3)5U5CA |
| .15 µF | C32(2)C154(3)5U5CA |
| .18 µF | C32(2)C184(3)5U5CA |
| .22 µF | C32(2)C224(3)5U5CA |
| .27 µF | C32(2)C274(3)5U5CA |
| .33 µF | C32(2)C334(3)5U5CA |
| .39 µF | C32(2)C394(3)5U5CA |
| .47 µF | C32(2)C474(3)5U5CA |
| .56 µF | C32(2)C564(3)5U5CA |
| 50 VOLT – C33X SIZE | |
| .27 µF | C33(4)C274(3)5U5CA |
| .33 µF | C33(4)C334(3)5U5CA |
| .39 µF | C33(4)C394(3)5U5CA |
| .47 µF | C33(4)C474(3)5U5CA |
| .56 µF | C33(4)C564(3)5U5CA |
| .68 µF | C33(4)C684(3)5U5CA |
| .82 µF | C33(4)C824(3)5U5CA |
| 1.0 µF | C33(4)C105(3)5U5CA |
| 1.2 µF | C33(4)C125(3)5U5CA |
| 1.5 µF | C33(4)C155(3)5U5CA |
| 1.8 µF | C33(4)C185(3)5U5CA |
| 2.2 µF | C33(4)C225(3)5U5CA |
| 50 VOLT – C340 SIZE | |
| 2.2 µF | C340C225(3)5U5CA |
| 2.7 µF | C340C275(3)5U5CA |
| 3.3 µF | C340C335(3)5U5CA |
| 3.9 µF | C340C395(3)5U5CA |
| 4.7 µF | C340C475(3)5U5CA |
| 50 VOLT – C350 SIZE | |
| 3.9 µF | C350C395(3)5U5CA |
| 4.7 µF | C350C475(3)5U5CA |
| 5.6 µF | C350C565(3)5U5CA |
| 6.8 µF | C350C685(3)5U5CA |

- NOTES:** (1) Case Sizes C315/C317 are identical electrically, but differ in lead spacing. See table of dimensions. Insert the appropriate symbol, "5" or "7" in the part number.
 (2) Case Sizes C320/C322/C323 are identical electrically. See table of dimensions. Insert the appropriate symbol, "0" or "2" or "3" in the part number.
 (3) Insert proper symbol for capacitance tolerance as follows:
 M – ±20%
 Z – +80%, -20%
 (4) Case Sizes C330 and C333 are identical electrically. Insert the appropriate symbol "0" or "3" in the part number.

GENERAL

Working Voltage:

C0G – 50, 100 & 200 Volts
X7R – 50, 100 & 200 Volts

Temperature Characteristics:

C0G – 0 ±30 PPM/°C from -55°C to +125°C
X7R – ±15% from -55°C to +125°C

Capacitance Tolerance:

C0G – ±0.5 pF, ±1%, ±2%, ±5%, ±10%, ±20%
(±0.5 pF is tightest available tolerance)
X7R – ±10%, ±20%, -0 +100%, -20% +80%

Construction:

Monolithic block of ceramic dielectric with interdigitated internal electrodes, encapsulated in a molded case, and having axial or radial leads. Meets flame test requirements of UL Standard 94V-0.

Terminal Strength:

EIA-RS-198D Method 303 Condition A (2.2 kg)

ELECTRICAL

Capacitance:

Within specified tolerance when measured with 1 volt rms at 1 kHz (1000 pF or less at 1 MHz for C0G).

Dissipation Factor:

25°C at 1 kHz (1000 pF or less at 1 MHz for C0G).
C0G – .15% maximum
X7R – 2.5% maximum

Insulation Resistance:

After 2 minutes electrification at 25°C and rated voltage
C0G – 100K megohms or 1000 megohm - μF, whichever is less.
X7R – 100K megohms or 1000 megohm - μF, whichever is less.

Dielectric Withstanding Voltage:

250% of rated voltage for 5 seconds with current limited to 50 mA at 25°C.

Life Test:

2000 hours at 200% of rated voltage at 125°C. Post-Test limits at 25°C are:

Capacitance Change:

C0G – less than 3% or 0.25 pF, whichever is higher
X7R – ±20% of initial value

Dissipation Factor:

C0G – .25% maximum
X7R – 3.0% maximum

Insulation Resistance:

C0G – 10K megohms or 100 megohm - μF, whichever is less
X7R – 10K megohms or 100 megohm - μF, whichever is less

Dielectric Withstanding Voltage:

250% of rated voltage for 5 seconds with current limited to 50 mA.

ENVIRONMENTAL

Moisture Resistance:

MIL-STD-202, Method 106, or EIA-RS-198D, Method 204, Condition A, except 20 cycles.

Insulation Resistance:

C0G – 10K megohms or 100 megohm - μF, whichever is less
X7R – 10K megohms or 100 megohm - μF, whichever is less

Dielectric Withstanding Voltage:

250% of rated voltage for 5 seconds with current limited to 50 mA.

Immersion Cycling:

MIL-STD-202, Method 104, Condition B. Post-Test limits at 25°C are:

Insulation Resistance:

C0G – 10K megohms or 100 megohm - μF, whichever is less
X7R – 10K megohms or 100 megohm - μF, whichever is less

Solderability:

MIL-STD-202, Method 208, Sn62 solder, 245°C for 5 ±1/2 seconds.

Resistance to Soldering Heat:

MIL-STD-202, Method 210, Condition B (260°C, 10 secs).
Depth of immersion – to a minimum of .050" from the capacitor body.

Lead Material:

Axial: Solder-coated copper clad steel
Radial: Solder-coated copper

CAPACITOR OUTLINE DRAWINGS – (AXIAL LEADS)

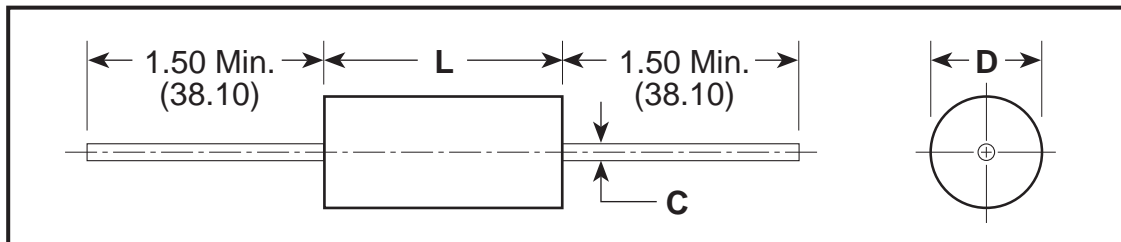

DIMENSIONS—INCHES & (MILLIMETERS)

| CASE SIZE | MILITARY EQUIVALENT STYLES | L | D | C |
|-----------|----------------------------|---------------------------|--------------------------|---------------------------------------|
| C114 | CC75, CCR75 CK12, CKR11 | .160 ± .010 (4.06 ± .25) | .090 ± .010 (2.29 ± .25) | .020, +.000, -.003 (.51, +.00, -.08) |
| C124 | CC76, CCR76 CK13, CKR12 | .250 ± .010 (6.35 ± .25) | .090 ± .010 (2.29 ± .25) | .020, +.000, -.003 (.51, +.00, -.08) |
| C192 | CC77, CCR77 CK14, CKR14 | .390 ± .010 (9.91 ± .25) | .140 ± .010 (3.56 ± .25) | .025, +.004, -.001 (.64, +.10, -.025) |
| C202 | CC78, CCR78 CK15, CKR15 | .500 ± .020 (12.70 ± .51) | .250 ± .015 (6.35 ± .38) | .025, +.004, -.001 (.64, +.10, -.025) |
| C222 | CC79, CCR79 CK16, CKR16 | .690 ± .030 (17.53 ± .76) | .350 ± .020 (8.89 ± .51) | .025, +.004, -.001 (.64, +.10, -.025) |

CAPACITOR OUTLINE DRAWINGS – (RADIAL LEADS)

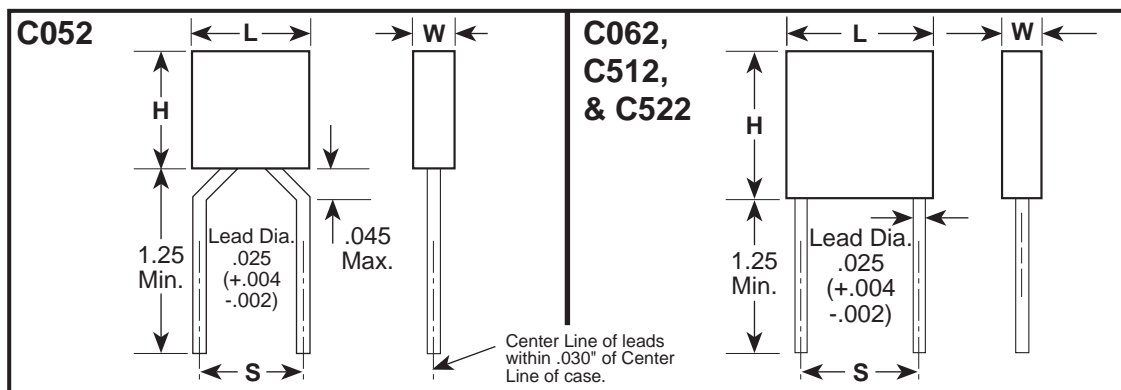

DIMENSIONS—INCHES & (MILLIMETERS)

| CASE SIZE | MILITARY EQUIVALENT STYLES | H HEIGHT | L LENGTH | W WIDTH | S LEAD SPACING |
|-----------|----------------------------|---------------------------|---------------------------|--------------------------|---------------------------|
| C052 | CC05, CCR05 CK05, CKR05 | .190 ± .010 (4.83 ± .25) | .190 ± .010 (4.83 ± .25) | .090 ± .010 (2.29 ± .25) | .200 ± .015 (5.08 ± .38) |
| C062 | CC06, CCR06 CK06, CKR06 | .290 ± .010 (7.37 ± .25) | .290 ± .010 (7.37 ± .25) | .090 ± .010 (2.29 ± .25) | .200 ± .015 (5.08 ± .38) |
| C512 | CC07, CCR07 | .480 ± .020 (12.19 ± .51) | .480 ± .020 (12.19 ± .51) | .140 ± .010 (3.56 ± .25) | .400 ± .020 (10.16 ± .51) |
| C522 | CC08, CCR08 | .480 ± .020 (12.19 ± .51) | .480 ± .020 (12.19 ± .51) | .240 ± .010 (6.10 ± .25) | .400 ± .020 (10.16 ± .51) |

For packaging information, see pages 32, 33 and 34.

ORDERING INFORMATION

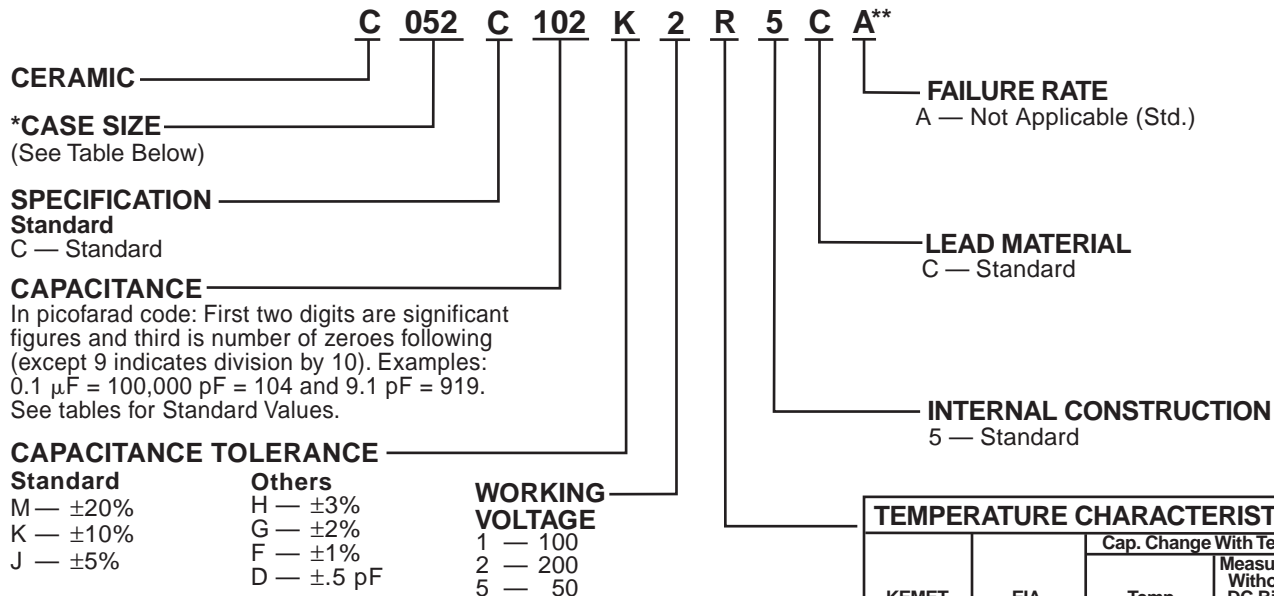

Standard tolerances for each Series are shown in the repetitive parts lists.

| *CASE SIZES | |
|-------------|-------|
| RADIAL | AXIAL |
| C052 | C114 |
| C062 | C124 |
| C512 | C192 |
| C522 | C202 |
| | C222 |

| TEMPERATURE CHARACTERISTIC | | | |
|----------------------------|----------------|------------------------|----------------------------------|
| KEMET Designator | EIA Equivalent | Cap. Change With Temp. | |
| | | Temp. Range, °C | Measured Without DC Bias Voltage |
| G (Ultra Stable) | C0G (NPO) | -55 to +125 | \pm 30 ppm/°C |
| R (Stable) | X7R | -55 to +125 | \pm 15% |

****Part Number Example: C052C102K2R5CA (14 digits – no spaces)**

AXIAL CAPACITOR MARKINGS
STANDARD C114C, C124C, C192C, C202C & C222C

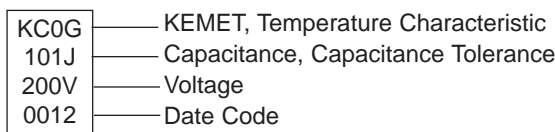

RADIAL CAPACITOR MARKINGS
C052C & C062C STANDARD MARKING

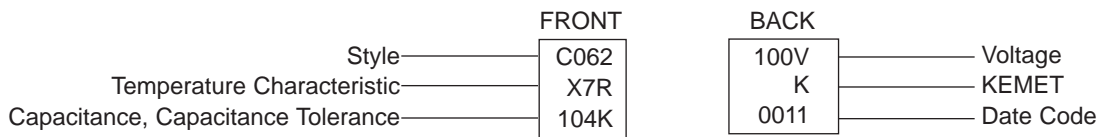

C512 & C522 STANDARD MARKING

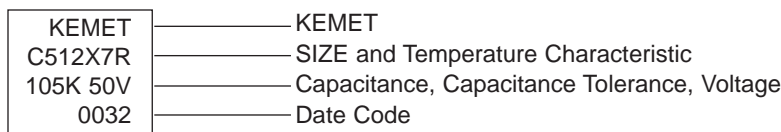

RATINGS & PART NUMBER REFERENCE

| CAPACITANCE pF | KEMET PART NUMBER |
|-------------------------------------|----------------------|
| 200 VOLT – C114 STANDARD C0G | |
| 1.0 | C114C109(1)2G5CA |
| 1.5 | C114C159(1)2G5CA |
| 2.2 | C114C229(1)2G5CA |
| 2.7 | C114C279(1)2G5CA |
| 3.3 | C114C339(1)2G5CA |
| 3.9 | C114C399(1)2G5CA |
| 4.7 | C114C479(1)2G5CA |
| 5.6 | C114C569(1)2G5CA |
| 6.8 | C114C689(1)2G5CA |
| 8.2 | C114C829(1)2G5CA |
| 10.0 | C114C100(2)2G5CA |
| 12.0 | C114C120(2)2G5CA |
| 15.0 | C114C150(2)2G5CA |
| 18.0 | C114C180(2)2G5CA |
| 22.0 | C114C220(2)2G5CA |
| 27.0 | C114C270(3)2G5CA |
| 33.0 | C114C330(3)2G5CA |
| 39.0 | C114C390(3)2G5CA |
| 47.0 | C114C470(3)2G5CA |
| 56.0 | C114C560(4)2G5CA |
| 68.0 | C114C680(4)2G5CA |
| 82.0 | C114C820(4)2G5CA |
| 100.0 | C114C101(4)2G5CA |
| 120.0 | C114C121(4)2G5CA |
| 150.0 | C114C151(4)2G5CA |
| 180.0 | C114C181(4)2G5CA |
| 220.0 | C114C221(4)2G5CA |
| 270.0 | C114C271(4)2G5CA |
| 330.0 | C114C331(4)2G5CA |
| 100 VOLT – C114 STANDARD C0G | |
| 82.0 | C114C820(4)1G5CA |
| 100.0 | C114C101(4)1G5CA |
| 120.0 | C114C121(4)1G5CA |
| 150.0 | C114C151(4)1G5CA |
| 180.0 | C114C181(4)1G5CA |
| 220.0 | C114C221(4)1G5CA |
| 270.0 | C114C271(4)1G5CA |
| 330.0 | C114C331(4)1G5CA |
| 390.0 | C114C391(4)1G5CA |
| 470.0 | C114C471(4)1G5CA |
| 560.0 | C114C561(4)1G5CA |
| 680.0 | C114C681(4)1G5CA |

| CAPACITANCE pF | KEMET PART NUMBER |
|-------------------------------------|----------------------|
| 200 VOLT – C124 STANDARD C0G | |
| 390.0 | C124C391(4)2G5CA |
| 470.0 | C124C471(4)2G5CA |
| 560.0 | C124C561(4)2G5CA |
| 100 VOLT – C124 STANDARD C0G | |
| 820.0 | C124C821(4)1G5CA |
| 1,000.0 | C124C102(4)1G5CA |
| 200 VOLT – C192 STANDARD C0G | |
| 680.0 | C192C681(4)2G5CA |
| 820.0 | C192C821(4)2G5CA |
| 1,000.0 | C192C102(4)2G5CA |
| 1,200.0 | C192C122(4)2G5CA |
| 1,500.0 | C192C152(4)2G5CA |
| 1,800.0 | C192C182(4)2G5CA |
| 2,200.0 | C192C222(4)2G5CA |
| 2,700.0 | C192C272(4)2G5CA |
| 3,300.0 | C192C332(4)2G5CA |
| 3,900.0 | C192C392(4)2G5CA |
| 4,700.0 | C192C472(4)2G5CA |
| 100 VOLT – C192 STANDARD C0G | |
| 1,200.0 | C192C122(4)1G5CA |
| 1,500.0 | C192C152(4)1G5CA |
| 1,800.0 | C192C182(4)1G5CA |
| 2,200.0 | C192C222(4)1G5CA |
| 2,700.0 | C192C272(4)1G5CA |
| 3,300.0 | C192C332(4)1G5CA |
| 3,900.0 | C192C392(4)1G5CA |
| 4,700.0 | C192C472(4)1G5CA |
| 5,600.0 | C192C562(4)1G5CA |
| 6,800.0 | C192C682(4)1G5CA |
| 8,200.0 | C192C822(4)1G5CA |

| CAPACITANCE pF | KEMET PART NUMBER |
|-------------------------------------|----------------------|
| 200 VOLT – C202 STANDARD C0G | |
| 5,600.0 | C202C562(4)2G5CA |
| 6,800.0 | C202C682(4)2G5CA |
| 8,200.0 | C202C822(4)2G5CA |
| 10,000.0 | C202C103(4)2G5CA |
| 12,000.0 | C202C123(4)2G5CA |
| 15,000.0 | C202C153(4)2G5CA |
| 18,000.0 | C202C183(4)2G5CA |
| 22,000.0 | C202C223(4)2G5CA |
| 100 VOLT – C202 STANDARD C0G | |
| 10,000.0 | C202C103(4)1G5CA |
| 12,000.0 | C202C123(4)1G5CA |
| 15,000.0 | C202C153(4)1G5CA |
| 18,000.0 | C202C183(4)1G5CA |
| 22,000.0 | C202C223(4)1G5CA |
| 27,000.0 | C202C273(4)1G5CA |
| 33,000.0 | C202C333(4)1G5CA |
| 200 VOLT – C222 STANDARD C0G | |
| 27,000.0 | C222C273(4)2G5CA |
| 33,000.0 | C222C333(4)2G5CA |
| 39,000.0 | C222C393(4)2G5CA |
| 47,000.0 | C222C473(4)2G5CA |
| 100 VOLT – C222 STANDARD C0G | |
| 39,000.0 | C222C393(4)1G5CA |
| 47,000.0 | C222C473(4)1G5CA |
| 56,000.0 | C222C563(4)1G5CA |
| 68,000.0 | C222C683(4)1G5CA |
| 82,000.0 | C222C823(4)1G5CA |
| 100,000.0 | C222C104(4)1G5CA |

NOTE 1: Insert proper symbol for capacitance tolerance as follows:

- (1) 1.0 pF to 8.2 pF: D— ±5 pF
- (2) 10.0 pF to 22 pF: J— ±5%, K— ±10%
- (3) 27.0 pF to 47 pF: G— ±2%, J— ±5%, K— ±10%
- (4) 56.0 pF and up: F— ±1%, G— ±2%, J— ±5%, K— ±10%

NOTE 1: Insert proper symbol for capacitance tolerance as follows:

- (1) 1.0 pF to 8.2 pF: D— ±5 pF
- (2) 10.0 pF to 22 pF: J— ±5%, K— ±10%
- (3) 27.0 pF to 47 pF: G— ±2%, J— ±5%, K— ±10%
- (4) 56.0 pF and up: F— ±1%, G— ±2%, J— ±5%, K— ±10%

NOTE 1: Insert proper symbol for capacitance tolerance as follows:

- (1) 1.0 pF to 8.2 pF: D— ±5 pF
- (2) 10.0 pF to 22 pF: J— ±5%, K— ±10%
- (3) 27.0 pF to 47 pF: G— ±2%, J— ±5%, K— ±10%
- (4) 56.0 pF and up: F— ±1%, G— ±2%, J— ±5%, K— ±10%

RATINGS & PART NUMBER REFERENCE

| CAPACITANCE pF | KEMET PART NUMBER |
|---------------------------------|----------------------|
| 200 VOLT – C052 SIZE C0G | |
| 1.0 | C052C109(1)2G5CA |
| 1.5 | C052C159(1)2G5CA |
| 2.2 | C052C229(1)2G5CA |
| 2.7 | C052C279(1)2G5CA |
| 3.3 | C052C339(1)2G5CA |
| 3.9 | C052C399(1)2G5CA |
| 4.7 | C052C479(1)2G5CA |
| 5.6 | C052C569(1)2G5CA |
| 6.8 | C052C689(1)2G5CA |
| 8.2 | C052C829(1)2G5CA |
| 10.0 | C052C100(2)2G5CA |
| 12.0 | C052C120(2)2G5CA |
| 15.0 | C052C150(2)2G5CA |
| 18.0 | C052C180(2)2G5CA |
| 22.0 | C052C220(2)2G5CA |
| 27.0 | C052C270(3)2G5CA |
| 33.0 | C052C330(3)2G5CA |
| 39.0 | C052C390(3)2G5CA |
| 47.0 | C052C470(3)2G5CA |
| 56.0 | C052C560(4)2G5CA |
| 68.0 | C052C680(4)2G5CA |
| 82.0 | C052C820(4)2G5CA |
| 100.0 | C052C101(4)2G5CA |
| 120.0 | C052C121(4)2G5CA |
| 150.0 | C052C151(4)2G5CA |
| 180.0 | C052C181(4)2G5CA |
| 220.0 | C052C221(4)2G5CA |
| 270.0 | C052C271(4)2G5CA |
| 330.0 | C052C331(4)2G5CA |
| 390.0 | C052C391(4)2G5CA |
| 470.0 | C052C471(4)2G5CA |
| 560.0 | C052C561(4)2G5CA |
| 680.0 | C052C681(4)2G5CA |
| 820.0 | C052C821(4)2G5CA |
| 1,000.0 | C052C102(4)2G5CA |
| 1,200.0 | C052C122(4)2G5CA |
| 1,500.0 | C052C152(4)2G5CA |
| 1,800.0 | C052C182(4)2G5CA |
| 2,200.0 | C052C222(4)2G5CA |
| 2,700.0 | C052C272(4)2G5CA |
| 100 VOLT – C052 SIZE C0G | |
| 390.0 | C052C391(4)1G5CA |
| 470.0 | C052C471(4)1G5CA |
| 560.0 | C052C561(4)1G5CA |
| 680.0 | C052C681(4)1G5CA |
| 820.0 | C052C821(4)1G5CA |
| 1,000.0 | C052C102(4)1G5CA |
| 1,200.0 | C052C122(4)1G5CA |
| 1,500.0 | C052C152(4)1G5CA |
| 1,800.0 | C052C182(4)1G5CA |
| 2,200.0 | C052C222(4)1G5CA |
| 2,700.0 | C052C272(4)1G5CA |
| 3,300.0 | C052C332(4)1G5CA |
| 3,900.0 | C052C392(4)1G5CA |
| 4,700.0 | C052C472(4)1G5CA |

NOTE 1: Insert proper symbol for capacitance tolerance as follows:

- (1) 1.0 pF to 8.2 pF: D— ±.5 pF
- (2) 10.0 pF to 22 pF: J— ±5%, K— ±10%
- (3) 27.0 pF to 47 pF: G— ±2%, J— ±5%, K— ±10%
- (4) 56.0 pF and up: F— ±1%, G— ±2%, J— ±5%, K— ±10%

| CAPACITANCE pF | KEMET PART NUMBER |
|---------------------------------|----------------------|
| 200 VOLT – C062 SIZE C0G | |
| 3,300.0 | C062C332(4)2G5CA |
| 3,900.0 | C062C392(4)2G5CA |
| 4,700.0 | C062C472(4)2G5CA |
| 5,600.0 | C062C562(4)2G5CA |
| 6,800.0 | C062C682(4)2G5CA |
| 8,200.0 | C062C822(4)2G5CA |
| 10,000.0 | C062C103(4)2G5CA |
| 100 VOLT – C062 SIZE C0G | |
| 5,600.0 | C062C562(4)1G5CA |
| 6,800.0 | C062C682(4)1G5CA |
| 8,200.0 | C062C822(4)1G5CA |
| 10,000.0 | C062C103(4)1G5CA |
| 12,000.0 | C062C123(4)1G5CA |
| 15,000.0 | C062C153(4)1G5CA |
| 18,000.0 | C062C183(4)1G5CA |
| 22,000.0 | C062C223(4)1G5CA |
| 200 VOLT – C512 SIZE C0G | |
| 12,000.0 | C512C123(4)2G5CA |
| 15,000.0 | C512C153(4)2G5CA |
| 18,000.0 | C512C183(4)2G5CA |
| 22,000.0 | C512C223(4)2G5CA |
| 27,000.0 | C512C273(4)2G5CA |
| 33,000.0 | C512C333(4)2G5CA |
| 39,000.0 | C512C393(4)2G5CA |
| 47,000.0 | C512C473(4)2G5CA |
| 56,000.0 | C512C563(4)2G5CA |
| 68,000.0 | C512C683(4)2G5CA |
| 100 VOLT – C512 SIZE C0G | |
| 27,000.0 | C512C273(4)1G5CA |
| 33,000.0 | C512C333(4)1G5CA |
| 39,000.0 | C512C393(4)1G5CA |
| 47,000.0 | C512C473(4)1G5CA |
| 56,000.0 | C512C563(4)1G5CA |
| 68,000.0 | C512C683(4)1G5CA |
| 82,000.0 | C512C823(4)1G5CA |
| 100,000.0 | C512C104(4)1G5CA |
| 200 VOLT – C522 SIZE C0G | |
| 82,000.0 | C522C823(4)2G5CA |
| 100,000.0 | C522C104(4)2G5CA |
| 100 VOLT – C522 SIZE C0G | |
| 120,000.0 | C522C124(4)1G5CA |
| 150,000.0 | C522C154(4)1G5CA |
| 180,000.0 | C522C184(4)1G5CA |

NOTE 1: Insert proper symbol for capacitance tolerance as follows:

- (1) 1.0 pF to 8.2 pF: D— ±.5 pF
- (2) 10.0 pF to 22 pF: J— ±5%, K— ±10%
- (3) 27.0 pF to 47 pF: G— ±2%, J— ±5%, K— ±10%
- (4) 56.0 pF and up: F— ±1%, G— ±2%, J— ±5%, K— ±10%

Ceramic Molded
Axial/Radial - Standard

RATINGS & PART NUMBER REFERENCE

| CAPACITANCE pF | TOL. % | KEMET PART NUMBER |
|-----------------------------|-----------|----------------------|
| 100 VOLT – C114 SIZE | | |
| 10 | 10 | C114C100K1R5CA |
| 10 | 20 | C114C100M1R5CA |
| 12 | 10 | C114C120K1R5CA |
| 15 | 10 | C114C150K1R5CA |
| 15 | 20 | C114C150M1R5CA |
| 18 | 10 | C114C180K1R5CA |
| 22 | 20 | C114C220K1R5CA |
| 22 | 10 | C114C220M1R5CA |
| 27 | 10 | C114C270K1R5CA |
| 33 | 10 | C114C330K1R5CA |
| 33 | 20 | C114C330M1R5CA |
| 39 | 10 | C114C390K1R5CA |
| 47 | 10 | C114C470K1R5CA |
| 47 | 20 | C114C470M1R5CA |
| 56 | 10 | C114C560K1R5CA |
| 68 | 10 | C114C680K1R5CA |
| 68 | 20 | C114C680M1R5CA |
| 82 | 10 | C114C820K1R5CA |
| 100 | 10 | C114C101K1R5CA |
| 100 | 20 | C114C101M1R5CA |
| 120 | 10 | C114C121K1R5CA |
| 150 | 10 | C114C151K1R5CA |
| 150 | 20 | C114C151M1R5CA |
| 180 | 10 | C114C181K1R5CA |
| 220 | 10 | C114C221K1R5CA |
| 220 | 20 | C114C221M1R5CA |
| 270 | 10 | C114C271K1R5CA |
| 330 | 10 | C114C331K1R5CA |
| 330 | 20 | C114C331M1R5CA |
| 390 | 10 | C114C391K1R5CA |
| 470 | 10 | C114C471K1R5CA |
| 470 | 20 | C114C471M1R5CA |
| 560 | 10 | C114C561K1R5CA |
| 680 | 10 | C114C681K1R5CA |
| 680 | 20 | C114C681M1R5CA |
| 820 | 10 | C114C821K1R5CA |
| 1,000 | 10 | C114C102K1R5CA |
| 1,000 | 20 | C114C102M1R5CA |
| 1,200 | 10 | C114C122K1R5CA |
| 1,500 | 10 | C114C152K1R5CA |
| 1,500 | 20 | C114C152M1R5CA |
| 1,800 | 10 | C114C182K1R5CA |
| 2,200 | 10 | C114C222K1R5CA |
| 2,200 | 20 | C114C222M1R5CA |
| 2,700 | 10 | C114C272K1R5CA |
| 3,300 | 10 | C114C332K1R5CA |
| 3,300 | 20 | C114C332M1R5CA |
| 3,900 | 10 | C114C392K1R5CA |
| 4,700 | 10 | C114C472K1R5CA |
| 4,700 | 20 | C114C472M1R5CA |
| 50 VOLT – C114 SIZE | | |
| 5,600 | 10 | C114C562K5R5CA |
| 6,800 | 10 | C114C682K5R5CA |
| 6,800 | 20 | C114C682M5R5CA |
| 8,200 | 10 | C114C822K5R5CA |
| 10,000 | 10 | C114C103K5R5CA |
| 10,000 | 20 | C114C103M5R5CA |

| CAPACITANCE pF | TOL. % | KEMET PART NUMBER |
|-----------------------------|-----------|----------------------|
| 100 VOLT – C124 SIZE | | |
| 5,600 | 10 | C124C562K1R5CA |
| 6,800 | 10 | C124C682K1R5CA |
| 6,800 | 20 | C124C682M1R5CA |
| 8,200 | 10 | C124C822K1R5CA |
| 10,000 | 10 | C124C103K1R5CA |
| 10,000 | 20 | C124C103M1R5CA |
| 50 VOLT – C124 SIZE | | |
| 12,000 | 10 | C124C123K5R5CA |
| 15,000 | 10 | C124C153K5R5CA |
| 15,000 | 20 | C124C153M5R5CA |
| 18,000 | 10 | C124C183K5R5CA |
| 22,000 | 10 | C124C223K5R5CA |
| 22,000 | 20 | C124C223M5R5CA |
| 27,000 | 10 | C124C273K5R5CA |
| 33,000 | 10 | C124C333K5R5CA |
| 33,000 | 20 | C124C333M5R5CA |
| 39,000 | 10 | C124C393K5R5CA |
| 47,000 | 10 | C124C473K5R5CA |
| 47,000 | 20 | C124C473M5R5CA |
| 100 VOLT – C192 SIZE | | |
| 12,000 | 10 | C192C123K1R5CA |
| 15,000 | 10 | C192C153K1R5CA |
| 15,000 | 20 | C192C153M1R5CA |
| 18,000 | 10 | C192C183K1R5CA |
| 22,000 | 10 | C192C223K1R5CA |
| 22,000 | 20 | C192C223M1R5CA |
| 27,000 | 10 | C192C273K1R5CA |
| 33,000 | 10 | C192C333K1R5CA |
| 33,000 | 20 | C192C333M1R5CA |
| 39,000 | 10 | C192C393K1R5CA |
| 47,000 | 10 | C192C473K1R5CA |
| 47,000 | 20 | C192C473M1R5CA |
| 56,000 | 10 | C192C563K1R5CA |
| 68,000 | 10 | C192C683K1R5CA |
| 68,000 | 20 | C192C683M1R5CA |
| 82,000 | 10 | C192C823K1R5CA |
| 100,000 | 10 | C192C104K1R5CA |
| 100,000 | 20 | C192C104M1R5CA |
| 50 VOLT – C192 SIZE | | |
| 56,000 | 10 | C192C563K5R5CA |
| 68,000 | 10 | C192C683K5R5CA |
| 68,000 | 20 | C192C683M5R5CA |
| 82,000 | 10 | C192C823K5R5CA |
| 100,000 | 10 | C192C104K5R5CA |
| 100,000 | 20 | C192C104M5R5CA |
| 120,000 | 10 | C192C124K5R5CA |
| 150,000 | 10 | C192C154K5R5CA |
| 150,000 | 20 | C192C154M5R5CA |
| 180,000 | 10 | C192C184K5R5CA |
| 220,000 | 10 | C192C224K5R5CA |
| 220,000 | 20 | C192C224M5R5CA |
| 270,000 | 10 | C192C274K5R5CA |

| CAPACITANCE pF | TOL. % | KEMET PART NUMBER |
|-----------------------------|-----------|----------------------|
| 100 VOLT – C202 SIZE | | |
| 56,000 | 10 | C202C563K1R5CA |
| 68,000 | 10 | C202C683K1R5CA |
| 68,000 | 20 | C202C683M1R5CA |
| 82,000 | 10 | C202C823K1R5CA |
| 100,000 | 10 | C202C104K1R5CA |
| 100,000 | 20 | C202C104M1R5CA |
| 120,000 | 10 | C202C124K1R5CA |
| 150,000 | 10 | C202C154K1R5CA |
| 150,000 | 20 | C202C154M1R5CA |
| 180,000 | 10 | C202C184K1R5CA |
| 220,000 | 10 | C202C224K1R5CA |
| 220,000 | 20 | C202C224M1R5CA |
| 270,000 | 10 | C202C274K1R5CA |
| 330,000 | 10 | C202C334K1R5CA |
| 330,000 | 20 | C202C334M1R5CA |
| 50 VOLT – C202 SIZE | | |
| 470,000 | 10 | C202C474K5R5CA |
| 470,000 | 20 | C202C474M5R5CA |
| 680,000 | 10 | C202C684K5R5CA |
| 680,000 | 20 | C202C684M5R5CA |
| 1,000,000 | 10 | C202C105K5R5CA |
| 1,000,000 | 20 | C202C105M5R5CA |
| 100 VOLT – C222 SIZE | | |
| 470,000 | 10 | C222C474K1R5CA |
| 470,000 | 20 | C222C474M1R5CA |
| 680,000 | 10 | C222C684K1R5CA |
| 680,000 | 20 | C222C684M1R5CA |
| 1,000,000 | 10 | C222C105K1R5CA |
| 1,000,000 | 20 | C222C105M1R5CA |
| 50 VOLT – C222 SIZE | | |
| 2,200,000 | 10 | C222C225K5R5CA |
| 2,200,000 | 20 | C222C225M5R5CA |
| 3,300,000 | 10 | C222C335K5R5CA |
| 3,300,000 | 20 | C222C335M5R5CA |

RATINGS & PART NUMBER REFERENCE

Ceramic Molded
 Axial/Radial - Standard

| CAPACITANCE pF | TOL. % | KEMET PART NUMBER |
|-----------------------------|-----------|----------------------|
| 200 VOLT – C052 SIZE | | |
| 10 | 10 | C052C100K2R5CA |
| 10 | 20 | C052C100M2R5CA |
| 12 | 10 | C052C120K2R5CA |
| 15 | 10 | C052C150K2R5CA |
| 15 | 20 | C052C150M2R5CA |
| 18 | 10 | C052C180K2R5CA |
| 22 | 10 | C052C220K2R5CA |
| 22 | 20 | C052C220M2R5CA |
| 27 | 10 | C052C270K2R5CA |
| 33 | 10 | C052C330K2R5CA |
| 33 | 20 | C052C330M2R5CA |
| 39 | 10 | C052C390K2R5CA |
| 47 | 10 | C052C470K2R5CA |
| 47 | 20 | C052C470M2R5CA |
| 56 | 10 | C052C560K2R5CA |
| 68 | 10 | C052C680K2R5CA |
| 68 | 20 | C052C680M2R5CA |
| 82 | 10 | C052C820K2R5CA |
| 100 | 10 | C052C101K2R5CA |
| 100 | 20 | C052C101M2R5CA |
| 120 | 10 | C052C121K2R5CA |
| 150 | 10 | C052C151K2R5CA |
| 150 | 20 | C052C151M2R5CA |
| 180 | 10 | C052C181K2R5CA |
| 220 | 10 | C052C221K2R5CA |
| 220 | 20 | C052C221M2R5CA |
| 270 | 10 | C052C271K2R5CA |
| 330 | 10 | C052C331K2R5CA |
| 330 | 20 | C052C331M2R5CA |
| 390 | 10 | C052C391K2R5CA |
| 470 | 10 | C052C471K2R5CA |
| 470 | 20 | C052C471M2R5CA |
| 560 | 10 | C052C561K2R5CA |
| 680 | 10 | C052C681K2R5CA |
| 680 | 20 | C052C681M2R5CA |
| 820 | 10 | C052C821K2R5CA |
| 1,000 | 10 | C052C102K2R5CA |
| 1,000 | 20 | C052C102M2R5CA |

| CAPACITANCE pF | TOL. % | KEMET PART NUMBER |
|-----------------------------|-----------|----------------------|
| 100 VOLT – C052 SIZE | | |
| 1,200 | 10 | C052C122K1R5CA |
| 1,500 | 10 | C052C152K1R5CA |
| 1,500 | 20 | C052C152M1R5CA |
| 1,800 | 10 | C052C182K1R5CA |
| 2,200 | 10 | C052C222K1R5CA |
| 2,200 | 20 | C052C222M1R5CA |
| 2,700 | 10 | C052C272K1R5CA |
| 3,300 | 10 | C052C332K1R5CA |
| 3,300 | 20 | C052C332M1R5CA |
| 3,900 | 10 | C052C392K1R5CA |
| 4,700 | 10 | C052C472K1R5CA |
| 4,700 | 20 | C052C472M1R5CA |
| 5,600 | 10 | C052C562K1R5CA |
| 6,800 | 10 | C052C682K1R5CA |
| 6,800 | 20 | C052C682M1R5CA |
| 8,200 | 10 | C052C822K1R5CA |
| 10,000 | 10 | C052C103K1R5CA |
| 10,000 | 20 | C052C103M1R5CA |
| 50 VOLT – C052 SIZE | | |
| 12,000 | 10 | C052C123K5R5CA |
| 15,000 | 10 | C052C153K5R5CA |
| 15,000 | 20 | C052C153M5R5CA |
| 18,000 | 10 | C052C183K5R5CA |
| 22,000 | 10 | C052C223K5R5CA |
| 22,000 | 20 | C052C223M5R5CA |
| 27,000 | 10 | C052C273K5R5CA |
| 33,000 | 10 | C052C333K5R5CA |
| 33,000 | 20 | C052C333M5R5CA |
| 39,000 | 10 | C052C393K5R5CA |
| 47,000 | 10 | C052C473K5R5CA |
| 47,000 | 20 | C052C473M5R5CA |
| 56,000 | 10 | C052C563K5R5CA |
| 68,000 | 10 | C052C683K5R5CA |
| 68,000 | 20 | C052C683M5R5CA |
| 82,000 | 10 | C052C823K5R5CA |
| 100,000 | 10 | C052C104K5R5CA |
| 100,000 | 20 | C052C104M5R5CA |
| 200 VOLT – C062 SIZE | | |
| 1,200 | 10 | C062C122K2R5CA |
| 1,500 | 10 | C062C152K2R5CA |
| 1,500 | 20 | C062C152M2R5CA |
| 1,800 | 10 | C062C182K2R5CA |
| 2,200 | 10 | C062C222K2R5CA |
| 2,200 | 20 | C062C222M2R5CA |
| 2,700 | 10 | C062C272K2R5CA |
| 3,300 | 10 | C062C332K2R5CA |
| 3,300 | 20 | C062C332M2R5CA |
| 3,900 | 10 | C062C392K2R5CA |
| 4,700 | 10 | C062C472K2R5CA |
| 4,700 | 20 | C062C472M2R5CA |
| 5,600 | 10 | C062C562K2R5CA |
| 6,800 | 10 | C062C682K2R5CA |
| 6,800 | 20 | C062C682M2R5CA |
| 8,200 | 10 | C062C822K2R5CA |
| 10,000 | 10 | C062C103K2R5CA |
| 10,000 | 20 | C062C103M2R5CA |
| 100 VOLT – C062 SIZE | | |
| 12,000 | 10 | C062C123K1R5CA |
| 15,000 | 10 | C062C153K1R5CA |
| 15,000 | 20 | C062C153M1R5CA |
| 18,000 | 10 | C062C183K1R5CA |
| 22,000 | 10 | C062C223K1R5CA |
| 22,000 | 20 | C062C223M1R5CA |
| 27,000 | 10 | C062C273K1R5CA |
| 33,000 | 10 | C062C333K1R5CA |
| 33,000 | 20 | C062C333M1R5CA |
| 39,000 | 10 | C062C393K1R5CA |
| 47,000 | 10 | C062C473K1R5CA |
| 47,000 | 20 | C062C473M1R5CA |
| 56,000 | 10 | C062C563K1R5CA |
| 68,000 | 10 | C062C683K1R5CA |
| 68,000 | 20 | C062C683M1R5CA |
| 82,000 | 10 | C062C823K1R5CA |
| 100,000 | 10 | C062C104K1R5CA |
| 100,000 | 20 | C062C104M1R5CA |
| 50 VOLT – C062 SIZE | | |
| 120,000 | 10 | C062C124K5R5CA |
| 150,000 | 10 | C062C154K5R5CA |
| 150,000 | 20 | C062C154M5R5CA |
| 180,000 | 10 | C062C184K5R5CA |
| 220,000 | 10 | C062C224K5R5CA |
| 220,000 | 20 | C062C224M5R5CA |
| 270,000 | 10 | C062C274K5R5CA |
| 330,000 | 10 | C062C334K5R5CA |
| 330,000 | 20 | C062C334M5R5CA |
| 390,000 | 10 | C062C394K5R5CA |
| 470,000 | 10 | C062C474K5R5CA |
| 470,000 | 20 | C062C474M5R5CA |
| 560,000 | 10 | C062C564K5R5CA |
| 680,000 | 10 | C062C684K5R5CA |
| 680,000 | 20 | C062C684M5R5CA |
| 820,000 | 10 | C062C824K5R5CA |
| 1,000,000 | 10 | C062C105K5R5CA |
| 1,000,000 | 20 | C062C105M5R5CA |
| 50 VOLT – C512 SIZE | | |
| 1,000,000 | 10 | C512C105K5X5CA |
| 1,000,000 | 20 | C512C105M5X5CA |
| 1,500,000 | 10 | C512C155K5X5CA |
| 1,500,000 | 20 | C512C155M5X5CA |
| 2,000,000 | 10 | C512C205K5X5CA |
| 2,000,000 | 20 | C512C205M5X5CA |
| 2,200,000 | 10 | C512C225K5X5CA |
| 2,200,000 | 20 | C512C225M5X5CA |
| 100 VOLT – C522 SIZE | | |
| 1,000,000 | 10 | C522C105K1X5CA |
| 1,000,000 | 20 | C522C105M1X5CA |
| 50 VOLT – C522 SIZE | | |
| 2,700,000 | 10 | C522C275K5X5CA |
| 2,700,000 | 20 | C522C275M5X5CA |
| 3,300,000 | 10 | C522C335K5X5CA |
| 3,300,000 | 20 | C522C335M5X5CA |

| CAPACITANCE pF | TOL. % | KEMET PART NUMBER |
|-----------------------------|-----------|----------------------|
| 100 VOLT – C062 SIZE | | |
| 12,000 | 10 | C062C123K1R5CA |
| 15,000 | 10 | C062C153K1R5CA |
| 15,000 | 20 | C062C153M1R5CA |
| 18,000 | 10 | C062C183K1R5CA |
| 22,000 | 10 | C062C223K1R5CA |
| 22,000 | 20 | C062C223M1R5CA |
| 27,000 | 10 | C062C273K1R5CA |
| 33,000 | 10 | C062C333K1R5CA |
| 33,000 | 20 | C062C333M1R5CA |
| 39,000 | 10 | C062C393K1R5CA |
| 47,000 | 10 | C062C473K1R5CA |
| 47,000 | 20 | C062C473M1R5CA |
| 56,000 | 10 | C062C563K1R5CA |
| 68,000 | 10 | C062C683K1R5CA |
| 68,000 | 20 | C062C683M1R5CA |
| 82,000 | 10 | C062C823K1R5CA |
| 100,000 | 10 | C062C104K1R5CA |
| 100,000 | 20 | C062C104M1R5CA |
| 50 VOLT – C062 SIZE | | |
| 120,000 | 10 | C062C124K5R5CA |
| 150,000 | 10 | C062C154K5R5CA |
| 150,000 | 20 | C062C154M5R5CA |
| 180,000 | 10 | C062C184K5R5CA |
| 220,000 | 10 | C062C224K5R5CA |
| 220,000 | 20 | C062C224M5R5CA |
| 270,000 | 10 | C062C274K5R5CA |
| 330,000 | 10 | C062C334K5R5CA |
| 330,000 | 20 | C062C334M5R5CA |
| 390,000 | 10 | C062C394K5R5CA |
| 470,000 | 10 | C062C474K5R5CA |
| 470,000 | 20 | C062C474M5R5CA |
| 560,000 | 10 | C062C564K5R5CA |
| 680,000 | 10 | C062C684K5R5CA |
| 680,000 | 20 | C062C684M5R5CA |
| 820,000 | 10 | C062C824K5R5CA |
| 1,000,000 | 10 | C062C105K5R5CA |
| 1,000,000 | 20 | C062C105M5R5CA |
| 50 VOLT – C512 SIZE | | |
| 1,000,000 | 10 | C512C105K5X5CA |
| 1,000,000 | 20 | C512C105M5X5CA |
| 1,500,000 | 10 | C512C155K5X5CA |
| 1,500,000 | 20 | C512C155M5X5CA |
| 2,000,000 | 10 | C512C205K5X5CA |
| 2,000,000 | 20 | C512C205M5X5CA |
| 2,200,000 | 10 | C512C225K5X5CA |
| 2,200,000 | 20 | C512C225M5X5CA |
| 100 VOLT – C522 SIZE | | |
| 1,000,000 | 10 | C522C105K1X5CA |
| 1,000,000 | 20 | C522C105M1X5CA |
| 50 VOLT – C522 SIZE | | |
| 2,700,000 | 10 | C522C275K5X5CA |
| 2,700,000 | 20 | C522C275M5X5CA |
| 3,300,000 | 10 | C522C335K5X5CA |
| 3,300,000 | 20 | C522C335M5X5CA |

CAPACITOR OUTLINE DRAWINGS (AXIAL LEADS)

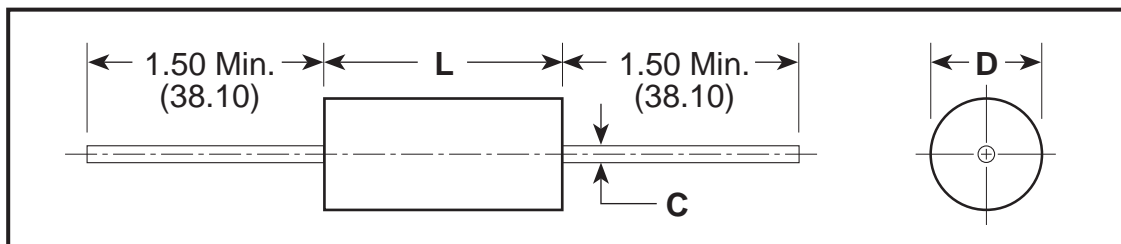

DIMENSIONS — INCHES & (MILLIMETERS)

| CASE SIZE | MILITARY EQUIVALENT STYLES | L | D | C |
|-----------|----------------------------|---------------------------|--------------------------|--------------------------------------|
| C114 | CC75, CCR75 | .160 ± .010 (4.06 ± .25) | .090 ± .010 (2.29 ± .25) | .020, +.000, -.003 (.51, +.00, -.08) |
| C124 | CC76, CCR76 | .250 ± .010 (6.35 ± .25) | .090 ± .010 (2.29 ± .25) | .020, +.000, -.003 (.51, +.00, -.08) |
| C192 | CC77, CCR77 | .390 ± .010 (9.91 ± .25) | .140 ± .010 (3.56 ± .25) | .025, +.002, -.002 (.64, +.05, -.05) |
| C202 | CC78, CCR78 | .500 ± .020 (12.70 ± .51) | .250 ± .015 (6.35 ± .38) | .025, +.002, -.002 (.64, +.05, -.05) |
| C222 | CC79, CCR79 | .690 ± .030 (17.53 ± .76) | .350 ± .020 (8.89 ± .51) | .025, +.002, -.002 (.64, +.05, -.05) |

CAPACITOR OUTLINE DRAWINGS (RADIAL LEADS)

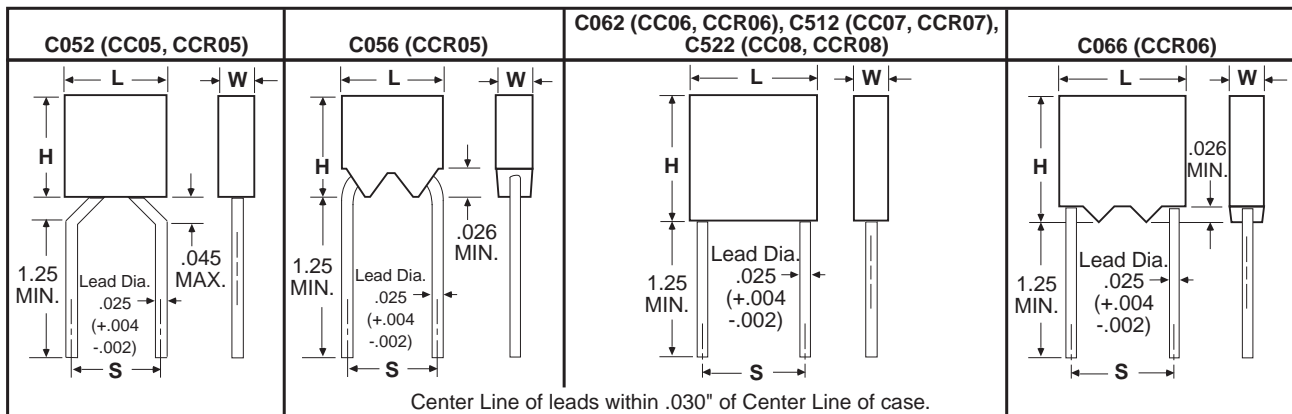

* Leads are .625 minimum when tape and reel packaged

DIMENSIONS — INCHES & (MILLIMETERS)

| CASE SIZE | MILITARY EQUIVALENT STYLES | H HEIGHT | L LENGTH | W WIDTH | S LEAD SPACING |
|---------------|----------------------------|---------------------------|---------------------------|---------------------------|---------------------------|
| C052/ C056 | CC05, CCR05 | .190 ± .010 (4.83 ± .25) | .190 ± .010 (4.83 ± .25) | .090 ± .010 (2.29 ± .25) | .200 ± .015 (5.08 ± .38) |
| C062/ C066 | CC06, CCR06 | .290 ± .010 (7.37 ± .25) | .290 ± .010 (7.37 ± .25) | .090 ± .010 (2.29 ± .25) | .200 ± .015 (5.08 ± .38) |
| C512 | CC07, CCR07 | .480 ± .020 (12.19 ± .51) | .480 ± .020 (12.19 ± .51) | .140 ± .010 (3.56 ± .25)* | .400 ± .020 (10.16 ± .51) |
| C522 | CC08, CCR08 | .480 ± .020 (12.19 ± .51) | .480 ± .020 (12.19 ± .51) | .240 ± .010 (6.10 ± .25) | .400 ± .020 (10.16 ± .51) |

* 0.200 (5.08) maximum for 100,000 pF only.

For packaging information, see pages 32, 33 and 34.

ORDERING INFORMATION

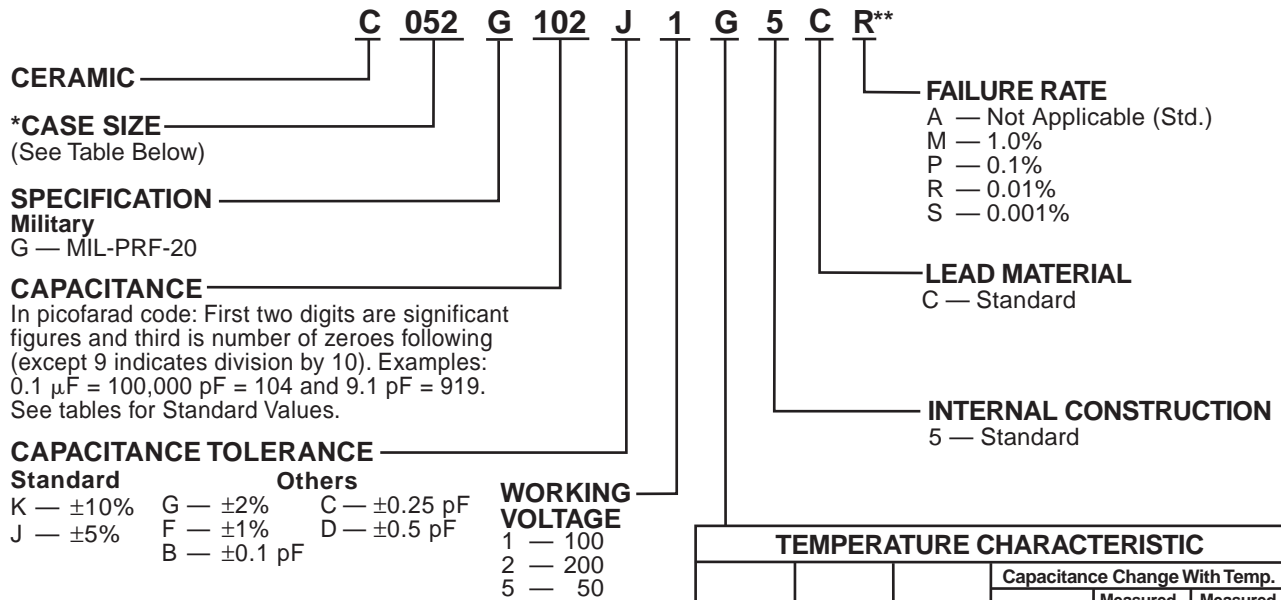

Standard tolerances for each Series are shown in the repetitive parts lists.

| *CASE SIZES | |
|-------------|-------|
| RADIAL | AXIAL |
| C052 | C114 |
| C056 | C124 |
| C062 | C192 |
| C066 | C202 |
| C512 | C222 |
| C522 | |

| TEMPERATURE CHARACTERISTIC | | | | | |
|----------------------------|---------------------|----------------|-------------------------------|----------------------------------|------------------------------------|
| KEMET Designator | Military Equivalent | EIA Equivalent | Capacitance Change With Temp. | | |
| | | | Temp. Range, °C | Measured Without DC Bias Voltage | Measured With Bias (Rated Voltage) |
| G (Ultra Stable) | *CG (See below) | C0G (NPO) | -55 to +125 | ± 30 ppm/°C* | ± 30 ppm/°C* |

*CH — ± 60 ppm/°C 8.2 pF-18.0 pF.
*CJ — ± 120 ppm/°C 4.3 pF-7.5 pF.
*CK — ± 250 ppm/°C 2.2 pF-3.9 pF.
*CX — not measurable 0.1 pF-2.0 pF.

**Part Number Example: C052G102J1G5CR (14 digits – no spaces)

CAPACITOR MARKINGS

CC(R) 75, 76

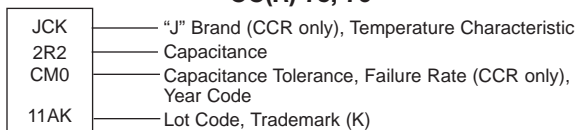

CC(R) 77

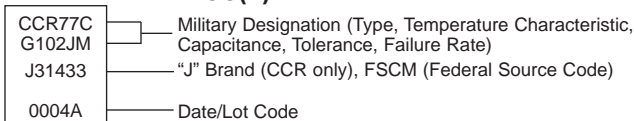

CC(R) 78

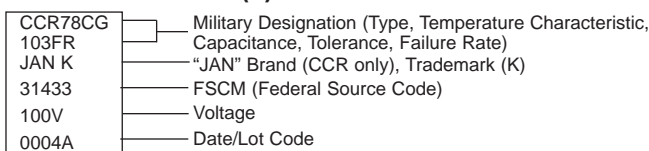

CC(R) 79

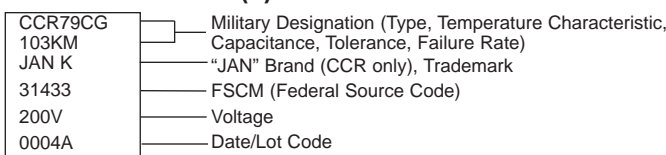

CC(R) 05

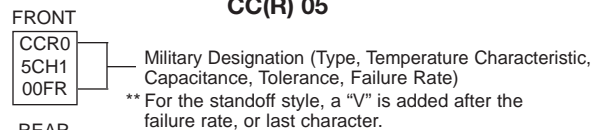

CC(R) 06

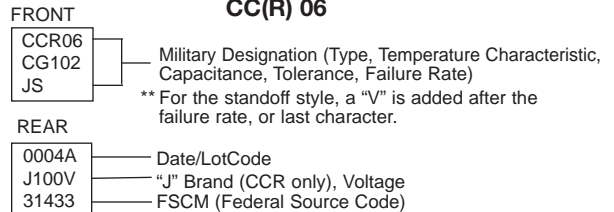

CC(R) 07

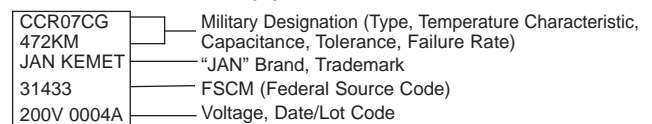

CC(R) 08

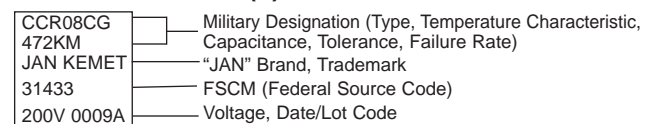

MIL-PRF-20

RATINGS & PART NUMBER REFERENCE

| CAP. pF | KEMET PART NUMBER | MILITARY STYLE CC | MILITARY STYLE CCR |
|--|--------------------|-------------------|--------------------|
| 200 VOLT — C114 (CC(R)75 PER MIL-PRF-20/27) | | | |
| 1.0 | C114G109(2)2G5C(1) | CC75CX1R0(2) | CCR75CX1R0(2)(1) |
| 1.1 | C114G119(2)2G5C(1) | CC75CX1R1(2) | CCR75CX1R1(2)(1) |
| 1.2 | C114G129(2)2G5C(1) | CC75CX1R2(2) | CCR75CX1R2(2)(1) |
| 1.3 | C114G139(2)2G5C(1) | CC75CX1R3(2) | CCR75CX1R3(2)(1) |
| 1.5 | C114G159(2)2G5C(1) | CC75CX1R5(2) | CCR75CX1R5(2)(1) |
| 1.6 | C114G169(2)2G5C(1) | CC75CX1R6(2) | CCR75CX1R6(2)(1) |
| 1.8 | C114G189(2)2G5C(1) | CC75CX1R8(2) | CCR75CX1R8(2)(1) |
| 2.0 | C114G209(2)2G5C(1) | CC75CX2R0(2) | CCR75CX2R0(2)(1) |
| 2.2 | C114G229(2)2G5C(1) | CC75CX2R2(2) | CCR75CX2R2(2)(1) |
| 2.4 | C114G249(2)2G5C(1) | CC75CX2R4(2) | CCR75CX2R4(2)(1) |
| 2.7 | C114G279(2)2G5C(1) | CC75CX2R7(3) | CCR75CX2R7(3)(1) |
| 3.0 | C114G309(3)2G5C(1) | CC75CX3R0(3) | CCR75CX3R0(3)(1) |
| 3.3 | C114G339(3)2G5C(1) | CC75CX3R3(3) | CCR75CX3R3(3)(1) |
| 3.6 | C114G369(3)2G5C(1) | CC75CX3R6(3) | CCR75CX3R6(3)(1) |
| 3.9 | C114G399(3)2G5C(1) | CC75CX3R9(3) | CCR75CX3R9(3)(1) |
| 4.3 | C114G439(3)2G5C(1) | CC75CX4R3(3) | CCR75CX4R3(3)(1) |
| 4.7 | C114G479(3)2G5C(1) | CC75CX4R7(3) | CCR75CX4R7(3)(1) |
| 5.1 | C114G519(3)2G5C(1) | CC75CX5R1(3) | CCR75CX5R1(3)(1) |
| 5.6 | C114G569(3)2G5C(1) | CC75CX5R6(3) | CCR75CX5R6(3)(1) |
| 6.2 | C114G629(3)2G5C(1) | CC75CX6R2(3) | CCR75CX6R2(3)(1) |
| 6.8 | C114G689(3)2G5C(1) | CC75CX6R8(3) | CCR75CX6R8(3)(1) |
| 7.5 | C114G759(3)2G5C(1) | CC75CX7R5(3) | CCR75CX7R5(3)(1) |
| 8.2 | C114G829(3)2G5C(1) | CC75CX8R2(3) | CCR75CX8R2(3)(1) |
| 9.1 | C114G919(3)2G5C(1) | CC75CX9R1(3) | CCR75CX9R1(3)(1) |
| 10.0 | C114G100(4)2G5C(1) | CC75CH100(4) | CCR75CH100(4)(1) |
| 11.0 | C114G110(4)2G5C(1) | CC75CH110(4) | CCR75CH110(4)(1) |
| 12.0 | C114G120(4)2G5C(1) | CC75CH120(4) | CCR75CH120(4)(1) |
| 13.0 | C114G130(4)2G5C(1) | CC75CH130(4) | CCR75CH130(4)(1) |
| 15.0 | C114G150(4)2G5C(1) | CC75CH150(4) | CCR75CH150(4)(1) |
| 16.0 | C114G160(4)2G5C(1) | CC75CH160(4) | CCR75CH160(4)(1) |
| 18.0 | C114G180(4)2G5C(1) | CC75CH180(4) | CCR75CH180(4)(1) |
| 20.0 | C114G200(4)2G5C(1) | CC75CG200(4) | CCR75CG200(4)(1) |
| 22.0 | C114G220(4)2G5C(1) | CC75CG220(4) | CCR75CG220(4)(1) |
| 24.0 | C114G240(4)2G5C(1) | CC75CG240(4) | CCR75CG240(4)(1) |
| 27.0 | C114G270(4)2G5C(1) | CC75CG270(4) | CCR75CG270(4)(1) |
| 30.0 | C114G300(4)2G5C(1) | CC75CG300(4) | CCR75CG300(4)(1) |
| 33.0 | C114G330(4)2G5C(1) | CC75CG330(4) | CCR75CG330(4)(1) |
| 36.0 | C114G360(4)2G5C(1) | CC75CG360(4) | CCR75CG360(4)(1) |
| 39.0 | C114G390(4)2G5C(1) | CC75CG390(4) | CCR75CG390(4)(1) |
| 43.0 | C114G430(4)2G5C(1) | CC75CG430(4) | CCR75CG430(4)(1) |
| 47.0 | C114G470(4)2G5C(1) | CC75CG470(4) | CCR75CG470(4)(1) |
| 51.0 | C114G510(4)2G5C(1) | CC75CG510(4) | CCR75CG510(4)(1) |
| 56.0 | C114G560(4)2G5C(1) | CC75CG560(4) | CCR75CG560(4)(1) |
| 62.0 | C114G620(4)2G5C(1) | CC75CG620(4) | CCR75CG620(4)(1) |
| 68.0 | C114G680(4)2G5C(1) | CC75CG680(4) | CCR75CG680(4)(1) |
| 75.0 | C114G750(4)2G5C(1) | CC75CG750(4) | CCR75CG750(4)(1) |

| CAP. pF | KEMET PART NUMBER | MILITARY STYLE CC | MILITARY STYLE CCR |
|--|--------------------|-------------------|--------------------|
| 100 VOLT — C114 (CC(R)75 PER MIL-PRF-20/27) | | | |
| 82.0 | C114G820(4)1G5C(1) | CC75CG820(4) | CCR75CG820(4)(1) |
| 91.0 | C114G910(4)1G5C(1) | CC75CG910(4) | CCR75CG910(4)(1) |
| 100.0 | C114G101(4)1G5C(1) | CC75CG101(4) | CCR75CG101(4)(1) |
| 110.0 | C114G111(4)1G5C(1) | CC75CG111(4) | CCR75CG111(4)(1) |
| 120.0 | C114G121(4)1G5C(1) | CC75CG121(4) | CCR75CG121(4)(1) |
| 130.0 | C114G131(4)1G5C(1) | CC75CG131(4) | CCR75CG131(4)(1) |
| 150.0 | C114G151(4)1G5C(1) | CC75CG151(4) | CCR75CG151(4)(1) |
| 160.0 | C114G161(4)1G5C(1) | CC75CG161(4) | CCR75CG161(4)(1) |
| 180.0 | C114G181(4)1G5C(1) | CC75CG181(4) | CCR75CG181(4)(1) |
| 200.0 | C114G201(4)1G5C(1) | CC75CG201(4) | CCR75CG201(4)(1) |
| 220.0 | C114G221(4)1G5C(1) | CC75CG221(4) | CCR75CG221(4)(1) |
| 240.0 | C114G241(4)1G5C(1) | CC75CG241(4) | CCR75CG241(4)(1) |
| 50 VOLT — C114 (CC(R)75 PER MIL-PRF-20/27) | | | |
| 270.0 | C114G271(4)5G5C(1) | CC75CG271(4) | CCR75CG271(4)(1) |
| 300.0 | C114G301(4)5G5C(1) | CC75CG301(4) | CCR75CG301(4)(1) |
| 330.0 | C114G331(4)5G5C(1) | CC75CG331(4) | CCR75CG331(4)(1) |
| 360.0 | C114G361(4)5G5C(1) | CC75CG361(4) | CCR75CG361(4)(1) |
| 390.0 | C114G391(4)5G5C(1) | CC75CG391(4) | CCR75CG391(4)(1) |
| 430.0 | C114G431(4)5G5C(1) | CC75CG431(4) | CCR75CG431(4)(1) |
| 470.0 | C114G471(4)5G5C(1) | CC75CG471(4) | CCR75CG471(4)(1) |
| 510.0 | C114G511(4)5G5C(1) | CC75CG511(4) | CCR75CG511(4)(1) |
| 560.0 | C114G561(4)5G5C(1) | CC75CG561(4) | CCR75CG561(4)(1) |
| 620.0 | C114G621(4)5G5C(1) | CC75CG621(4) | CCR75CG621(4)(1) |
| 680.0 | C114G681(4)5G5C(1) | CC75CG681(4) | CCR75CG681(4)(1) |
| 200 VOLT — C124 (CC(R)76 PER MIL-PRF-20/28) | | | |
| 82.0 | C124G820(4)2G5C(1) | CC76CG820(4) | CCR76CG820(4)(1) |
| 91.0 | C124G910(4)2G5C(1) | CC76CG910(4) | CCR76CG910(4)(1) |
| 100.0 | C124G101(4)2G5C(1) | CC76CG101(4) | CCR76CG101(4)(1) |
| 110.0 | C124G111(4)2G5C(1) | CC76CG111(4) | CCR76CG111(4)(1) |
| 120.0 | C124G121(4)2G5C(1) | CC76CG121(4) | CCR76CG121(4)(1) |
| 130.0 | C124G131(4)2G5C(1) | CC76CG131(4) | CCR76CG131(4)(1) |
| 100 VOLT — C124 (CC(R)76 PER MIL-PRF-20/28) | | | |
| 270.0 | C124G271(4)1G5C(1) | CC76CG271(4) | CCR76CG271(4)(1) |
| 300.0 | C124G301(4)1G5C(1) | CC76CG301(4) | CCR76CG301(4)(1) |
| 330.0 | C124G331(4)1G5C(1) | CC76CG331(4) | CCR76CG331(4)(1) |
| 360.0 | C124G361(4)1G5C(1) | CC76CG361(4) | CCR76CG361(4)(1) |
| 390.0 | C124G391(4)1G5C(1) | CC76CG391(4) | CCR76CG391(4)(1) |
| 430.0 | C124G431(4)1G5C(1) | CC76CG431(4) | CCR76CG431(4)(1) |
| 470.0 | C124G471(4)1G5C(1) | CC76CG471(4) | CCR76CG471(4)(1) |
| 510.0 | C124G511(4)1G5C(1) | CC76CG511(4) | CCR76CG511(4)(1) |
| 560.0 | C124G561(4)1G5C(1) | CC76CG561(4) | CCR76CG561(4)(1) |
| 620.0 | C124G621(4)1G5C(1) | CC76CG621(4) | CCR76CG621(4)(1) |
| 680.0 | C124G681(4)1G5C(1) | CC76CG681(4) | CCR76CG681(4)(1) |
| 50 VOLT — C124 (CC(R)76 PER MIL-PRF-20/28) | | | |
| 750.0 | C124G751(4)5G5C(1) | CC76CG751(4) | CCR76CG751(4)(1) |
| 820.0 | C124G821(4)5G5C(1) | CC76CG821(4) | CCR76CG821(4)(1) |
| 910.0 | C124G911(4)5G5C(1) | CC76CG911(4) | CCR76CG911(4)(1) |
| 1,000.0 | C124G102(4)5G5C(1) | CC76CG102(4) | CCR76CG102(4)(1) |
| 200 VOLT — C192 (CC(R)77 PER MIL-PRF-20/29) | | | |
| 150.0 | C192G151(4)2G5C(1) | CC77CG151(4) | CCR77CG151(4)(1) |
| 160.0 | C192G161(4)2G5C(1) | CC77CG161(4) | CCR77CG161(4)(1) |
| 180.0 | C192G181(4)2G5C(1) | CC77CG181(4) | CCR77CG181(4)(1) |
| 200.0 | C192G201(4)2G5C(1) | CC77CG201(4) | CCR77CG201(4)(1) |
| 220.0 | C192G221(4)2G5C(1) | CC77CG221(4) | CCR77CG221(4)(1) |
| 240.0 | C192G241(4)2G5C(1) | CC77CG241(4) | CCR77CG241(4)(1) |
| 270.0 | C192G271(4)2G5C(1) | CC77CG271(4) | CCR77CG271(4)(1) |
| 300.0 | C192G301(4)2G5C(1) | CC77CG301(4) | CCR77CG301(4)(1) |
| 330.0 | C192G331(4)2G5C(1) | CC77CG331(4) | CCR77CG331(4)(1) |
| 360.0 | C192G361(4)2G5C(1) | CC77CG361(4) | CCR77CG361(4)(1) |
| 390.0 | C192G391(4)2G5C(1) | CC77CG391(4) | CCR77CG391(4)(1) |
| 430.0 | C192G431(4)2G5C(1) | CC77CG431(4) | CCR77CG431(4)(1) |
| 470.0 | C192G471(4)2G5C(1) | CC77CG471(4) | CCR77CG471(4)(1) |
| 510.0 | C192G511(4)2G5C(1) | CC77CG511(4) | CCR77CG511(4)(1) |
| 560.0 | C192G561(4)2G5C(1) | CC77CG561(4) | CCR77CG561(4)(1) |
| 620.0 | C192G621(4)2G5C(1) | CC77CG621(4) | CCR77CG621(4)(1) |
| 680.0 | C192G681(4)2G5C(1) | CC77CG681(4) | CCR77CG681(4)(1) |

To complete Part Number, insert the following letters:
 (1) Available Failure Rates: A (CC styles only); M, P, R & S (CCR styles only).
 (2) Available Capacitance Tolerances: B, C.
 (3) Available Capacitance Tolerances: B, C, D.
 (4) Available Capacitance Tolerances: F, G, J.

RATINGS & PART NUMBER REFERENCE

| CAP. pF | KEMET PART NUMBER | MILITARY STYLE CC | MILITARY STYLE CCR |
|--|--------------------|-------------------|--------------------|
| 100 VOLT — C192 (CC(R)77 PER MIL-PRF-20/29) | | | |
| 750.0 | C192G751(4)1G5C(1) | CC77CG751(4) | CCR77CG751(4)(1) |
| 820.0 | C192G821(4)1G5C(1) | CC77CG821(4) | CCR77CG821(4)(1) |
| 910.0 | C192G911(4)1G5C(1) | CC77CG911(4) | CCR77CG911(4)(1) |
| 1,000.0 | C192G102(4)1G5C(1) | CC77CG102(4) | CCR77CG102(4)(1) |
| 1,100.0 | C192G112(4)1G5C(1) | CC77CG112(4) | CCR77CG112(4)(1) |
| 1,200.0 | C192G122(4)1G5C(1) | CC77CG122(4) | CCR77CG122(4)(1) |
| 1,300.0 | C192G132(4)1G5C(1) | CC77CG132(4) | CCR77CG132(4)(1) |
| 1,500.0 | C192G152(4)1G5C(1) | CC77CG152(4) | CCR77CG152(4)(1) |
| 1,600.0 | C192G162(4)1G5C(1) | CC77CG162(4) | CCR77CG162(4)(1) |
| 1,800.0 | C192G182(4)1G5C(1) | CC77CG182(4) | CCR77CG182(4)(1) |
| 2,000.0 | C192G202(4)1G5C(1) | CC77CG202(4) | CCR77CG202(4)(1) |
| 2,200.0 | C192G222(4)1G5C(1) | CC77CG222(4) | CCR77CG222(4)(1) |
| 50 VOLT — C192 (CC(R)77 PER MIL-PRF-20/29) | | | |
| 2,400.0 | C192G242(4)5G5C(1) | CC77CG242(4) | CCR77CG242(4)(1) |
| 2,700.0 | C192G272(4)5G5C(1) | CC77CG272(4) | CCR77CG272(4)(1) |
| 3,000.0 | C192G302(4)5G5C(1) | CC77CG302(4) | CCR77CG302(4)(1) |
| 3,300.0 | C192G332(4)5G5C(1) | CC77CG332(4) | CCR77CG332(4)(1) |
| 3,600.0 | C192G362(4)5G5C(1) | CC77CG362(4) | CCR77CG362(4)(1) |
| 3,900.0 | C192G392(4)5G5C(1) | CC77CG392(4) | CCR77CG392(4)(1) |
| 4,300.0 | C192G432(4)5G5C(1) | CC77CG432(4) | CCR77CG432(4)(1) |
| 4,700.0 | C192G472(4)5G5C(1) | CC77CG472(4) | CCR77CG472(4)(1) |
| 5,100.0 | C192G512(5)5G5C(1) | CC77CG512(5) | CCR77CG512(5)(1) |
| 5,600.0 | C192G562(5)5G5C(1) | CC77CG562(5) | CCR77CG562(5)(1) |
| 200 VOLT — C202 (CC(R)78 PER MIL-PRF-20/30) | | | |
| 820.0 | C202G821(5)2G5C(1) | CC78CG821(5) | CCR78CG821(5)(1) |
| 1,000.0 | C202G102(5)2G5C(1) | CC78CG102(5) | CCR78CG102(5)(1) |
| 1,200.0 | C202G122(5)2G5C(1) | CC78CG122(5) | CCR78CG122(5)(1) |
| 1,500.0 | C202G152(5)2G5C(1) | CC78CG152(5) | CCR78CG152(5)(1) |
| 1,800.0 | C202G182(5)2G5C(1) | CC78CG182(5) | CCR78CG182(5)(1) |
| 2,200.0 | C202G222(5)2G5C(1) | CC78CG222(5) | CCR78CG222(5)(1) |
| 2,700.0 | C202G272(5)2G5C(1) | CC78CG272(5) | CCR78CG272(5)(1) |
| 3,300.0 | C202G332(5)2G5C(1) | CC78CG332(5) | CCR78CG332(5)(1) |

| CAP. pF | KEMET PART NUMBER | MILITARY STYLE CC | MILITARY STYLE CCR |
|--|--------------------|-------------------|--------------------|
| 100 VOLT — C202 (CC(R)78 PER MIL-PRF-20/30) | | | |
| 3,900.0 | C202G392(5)1G5C(1) | CC78CG392(5) | CCR78CG392(5)(1) |
| 4,700.0 | C202G472(5)1G5C(1) | CC78CG472(5) | CCR78CG472(5)(1) |
| 5,600.0 | C202G562(5)1G5C(1) | CC78CG562(5) | CCR78CG562(5)(1) |
| 6,800.0 | C202G682(5)1G5C(1) | CC78CG682(5) | CCR78CG682(5)(1) |
| 8,200.0 | C202G822(5)1G5C(1) | CC78CG822(5) | CCR78CG822(5)(1) |
| 10,000.0 | C202G103(5)1G5C(1) | CC78CG103(5) | CCR78CG103(5)(1) |
| 12,000.0 | C202G123(5)1G5C(1) | CC78CG123(5) | CCR78CG123(5)(1) |
| 50 VOLT — C202 (CC(R)78 PER MIL-PRF-20/30) | | | |
| 15,000.0 | C202G153(5)5G5C(1) | CC78CG153(5) | CCR78CG153(5)(1) |
| 18,000.0 | C202G183(5)5G5C(1) | CC78CG183(5) | CCR78CG183(5)(1) |
| 22,000.0 | C202G223(5)5G5C(1) | CC78CG223(5) | CCR78CG223(5)(1) |
| 27,000.0 | C202G273(5)5G5C(1) | CC78CG273(5) | CCR78CG273(5)(1) |
| 200 VOLT — C222 (CC(R)79 PER MIL-PRF-20/31) | | | |
| 3,900.0 | C222G392(5)2G5C(1) | CC79CG392(5) | CCR79CG392(5)(1) |
| 4,700.0 | C222G472(5)2G5C(1) | CC79CG472(5) | CCR79CG472(5)(1) |
| 5,600.0 | C222G562(5)2G5C(1) | CC79CG562(5) | CCR79CG562(5)(1) |
| 6,800.0 | C222G682(5)2G5C(1) | CC79CG682(5) | CCR79CG682(5)(1) |
| 8,200.0 | C222G822(5)2G5C(1) | CC79CG822(5) | CCR79CG822(5)(1) |
| 10,000.0 | C222G103(5)2G5C(1) | CC79CG103(5) | CCR79CG103(5)(1) |
| 100 VOLT — C222 (CC(R)79 PER MIL-PRF-20/31) | | | |
| 15,000.0 | C222G153(5)1G5C(1) | CC79CG153(5) | CCR79CG153(5)(1) |
| 18,000.0 | C222G183(5)1G5C(1) | CC79CG183(5) | CCR79CG183(5)(1) |
| 22,000.0 | C222G223(5)1G5C(1) | CC79CG223(5) | CCR79CG223(5)(1) |
| 27,000.0 | C222G273(5)1G5C(1) | CC79CG273(5) | CCR79CG273(5)(1) |
| 33,000.0 | C222G333(5)1G5C(1) | CC79CG333(5) | CCR79CG333(5)(1) |
| 39,000.0 | C222G393(5)1G5C(1) | CC79CG393(5) | CCR79CG393(5)(1) |
| 50 VOLT — C222 (CC(R)79 PER MIL-PRF-20/31) | | | |
| 47,000.0 | C222G473(5)5G5C(1) | CC79CG473(5) | CCR79CG473(5)(1) |
| 56,000.0 | C222G563(5)5G5C(1) | CC79CG563(5) | CCR79CG563(5)(1) |
| 68,000.0 | C222G683(5)5G5C(1) | CC79CG683(5) | CCR79CG683(5)(1) |
| 82,000.0 | C222G823(5)5G5C(1) | CC79CG823(5) | CCR79CG823(5)(1) |

To complete Part Number, insert the following letters:
 (1) Available Failure Rates: A (CC styles only); M, P, R & S (CCR styles only).
 (2) Available Capacitance Tolerances: B, C.
 (3) Available Capacitance Tolerances: B, C, D.
 (4) Available Capacitance Tolerances: F, G, J.
 (5) Available Capacitance Tolerances: F, G, J, K.

MIL-PRF-20

RATINGS & PART NUMBER REFERENCE

| CAP. pF | KEMET PART NUMBER | MILITARY STYLE CC | MILITARY STYLE CCR |
|--|----------------------|-------------------|---------------------|
| 200 VOLT — C052/C056 SIZE (CC(R)05 PER MIL-PRF-20/35) | | | |
| 1.0 | C05(6)G109(2)2G5C(1) | CC05CX1R0(2) | CCR05CX1R0(2)(1)(7) |
| 1.1 | C05(6)G119(2)2G5C(1) | CC05CX1R1(2) | CCR05CX1R1(2)(1)(7) |
| 1.2 | C05(6)G129(2)2G5C(1) | CC05CX1R2(2) | CCR05CX1R2(2)(1)(7) |
| 1.3 | C05(6)G139(2)2G5C(1) | CC05CX1R3(2) | CCR05CX1R3(2)(1)(7) |
| 1.5 | C05(6)G159(2)2G5C(1) | CC05CX1R5(2) | CCR05CX1R5(2)(1)(7) |
| 1.6 | C05(6)G169(2)2G5C(1) | CC05CX1R6(2) | CCR05CX1R6(2)(1)(7) |
| 1.8 | C05(6)G189(2)2G5C(1) | CC05CX1R8(2) | CCR05CX1R8(2)(1)(7) |
| 2.0 | C05(6)G209(2)2G5C(1) | CC05CX2R0(2) | CCR05CX2R0(2)(1)(7) |
| 2.2 | C05(6)G229(2)2G5C(1) | CC05CX2R2(2) | CCR05CX2R2(2)(1)(7) |
| 2.4 | C05(6)G249(2)2G5C(1) | CC05CX2R4(2) | CCR05CX2R4(2)(1)(7) |
| 2.7 | C05(6)G279(3)2G5C(1) | CC05CX2R7(3) | CCR05CX2R7(3)(1)(7) |
| 3.0 | C05(6)G309(3)2G5C(1) | CC05CX3R0(3) | CCR05CX3R0(3)(1)(7) |
| 3.3 | C05(6)G339(3)2G5C(1) | CC05CX3R3(3) | CCR05CX3R3(3)(1)(7) |
| 3.6 | C05(6)G369(3)2G5C(1) | CC05CX3R6(3) | CCR05CX3R6(3)(1)(7) |
| 3.9 | C05(6)G399(3)2G5C(1) | CC05CX3R9(3) | CCR05CX3R9(3)(1)(7) |
| 4.3 | C05(6)G439(3)2G5C(1) | CC05CX4R3(3) | CCR05CX4R3(3)(1)(7) |
| 4.7 | C05(6)G479(3)2G5C(1) | CC05CX4R7(3) | CCR05CX4R7(3)(1)(7) |
| 5.1 | C05(6)G519(3)2G5C(1) | CC05CX5R1(3) | CCR05CX5R1(3)(1)(7) |
| 5.6 | C05(6)G569(3)2G5C(1) | CC05CX5R6(3) | CCR05CX5R6(3)(1)(7) |
| 6.2 | C05(6)G629(3)2G5C(1) | CC05CX6R2(3) | CCR05CX6R2(3)(1)(7) |
| 6.8 | C05(6)G689(3)2G5C(1) | CC05CX6R8(3) | CCR05CX6R8(3)(1)(7) |
| 7.5 | C05(6)G759(3)2G5C(1) | CC05CX7R5(3) | CCR05CX7R5(3)(1)(7) |
| 8.2 | C05(6)G829(3)2G5C(1) | CC05CX8R2(3) | CCR05CX8R2(3)(1)(7) |
| 9.1 | C05(6)G919(3)2G5C(1) | CC05CX9R1(3) | CCR05CX9R1(3)(1)(7) |
| 10.0 | C05(6)G100(4)2G5C(1) | CC05CH100(4) | CCR05CH100(4)(1)(7) |
| 11.0 | C05(6)G110(4)2G5C(1) | CC05CH110(4) | CCR05CH110(4)(1)(7) |
| 12.0 | C05(6)G120(4)2G5C(1) | CC05CH120(4) | CCR05CH120(4)(1)(7) |
| 13.0 | C05(6)G130(4)2G5C(1) | CC05CH130(4) | CCR05CH130(4)(1)(7) |
| 15.0 | C05(6)G150(4)2G5C(1) | CC05CH150(4) | CCR05CH150(4)(1)(7) |
| 16.0 | C05(6)G160(4)2G5C(1) | CC05CH160(4) | CCR05CH160(4)(1)(7) |
| 18.0 | C05(6)G180(4)2G5C(1) | CC05CH180(4) | CCR05CH180(4)(1)(7) |
| 20.0 | C05(6)G200(4)2G5C(1) | CC05CG200(4) | CCR05CG200(4)(1)(7) |
| 22.0 | C05(6)G220(4)2G5C(1) | CC05CG220(4) | CCR05CG220(4)(1)(7) |
| 24.0 | C05(6)G240(4)2G5C(1) | CC05CG240(4) | CCR05CG240(4)(1)(7) |
| 27.0 | C05(6)G270(4)2G5C(1) | CC05CG270(4) | CCR05CG270(4)(1)(7) |
| 30.0 | C05(6)G300(4)2G5C(1) | CC05CG300(4) | CCR05CG300(4)(1)(7) |
| 33.0 | C05(6)G330(4)2G5C(1) | CC05CG330(4) | CCR05CG330(4)(1)(7) |
| 36.0 | C05(6)G360(4)2G5C(1) | CC05CG360(4) | CCR05CG360(4)(1)(7) |
| 39.0 | C05(6)G390(4)2G5C(1) | CC05CG390(4) | CCR05CG390(4)(1)(7) |
| 43.0 | C05(6)G430(4)2G5C(1) | CC05CG430(4) | CCR05CG430(4)(1)(7) |
| 47.0 | C05(6)G470(4)2G5C(1) | CC05CG470(4) | CCR05CG470(4)(1)(7) |
| 51.0 | C05(6)G510(4)2G5C(1) | CC05CG510(4) | CCR05CG510(4)(1)(7) |

| CAP. pF | KEMET PART NUMBER | MILITARY STYLE CC | MILITARY STYLE CCR |
|--|----------------------|-------------------|---------------------|
| 200 VOLT — C052/C056 SIZE (CC(R)05 PER MIL-PRF-20/35) | | | |
| 56.0 | C05(6)G560(4)2G5C(1) | CC05CG560(4) | CCR05CG560(4)(1)(7) |
| 62.0 | C05(6)G620(4)2G5C(1) | CC05CG620(4) | CCR05CG620(4)(1)(7) |
| 68.0 | C05(6)G680(4)2G5C(1) | CC05CG680(4) | CCR05CG680(4)(1)(7) |
| 75.0 | C05(6)G750(4)2G5C(1) | CC05CG750(4) | CCR05CG750(4)(1)(7) |
| 82.0 | C05(6)G820(4)2G5C(1) | CC05CG820(4) | CCR05CG820(4)(1)(7) |
| 91.0 | C05(6)G910(4)2G5C(1) | CC05CG910(4) | CCR05CG910(4)(1)(7) |
| 100.0 | C05(6)G101(4)2G5C(1) | CC05CG101(4) | CCR05CG101(4)(1)(7) |
| 110.0 | C05(6)G111(4)2G5C(1) | CC05CG111(4) | CCR05CG111(4)(1)(7) |
| 120.0 | C05(6)G121(4)2G5C(1) | CC05CG121(4) | CCR05CG121(4)(1)(7) |
| 130.0 | C05(6)G131(4)2G5C(1) | CC05CG131(4) | CCR05CG131(4)(1)(7) |
| 150.0 | C05(6)G151(4)2G5C(1) | CC05CG151(4) | CCR05CG151(4)(1)(7) |
| 160.0 | C05(6)G161(4)2G5C(1) | CC05CG161(4) | CCR05CG161(4)(1)(7) |
| 180.0 | C05(6)G181(4)2G5C(1) | CC05CG181(4) | CCR05CG181(4)(1)(7) |
| 200.0 | C05(6)G201(4)2G5C(1) | CC05CG201(4) | CCR05CG201(4)(1)(7) |
| 220.0 | C05(6)G221(4)2G5C(1) | CC05CG221(4) | CCR05CG221(4)(1)(7) |
| 240.0 | C05(6)G241(4)2G5C(1) | CC05CG241(4) | CCR05CG241(4)(1)(7) |
| 270.0 | C05(6)G271(4)2G5C(1) | CC05CG271(4) | CCR05CG271(4)(1)(7) |
| 300.0 | C05(6)G301(4)2G5C(1) | CC05CG301(4) | CCR05CG301(4)(1)(7) |
| 330.0 | C05(6)G331(4)2G5C(1) | CC05CG331(4) | CCR05CG331(4)(1)(7) |
| 100 VOLT — C052/C056 SIZE (CC(R)05 PER MIL-PRF-20/35) | | | |
| 360.0 | C05(6)G361(4)1G5C(1) | CC05CG361(4) | CCR05CG361(4)(1)(7) |
| 390.0 | C05(6)G391(4)1G5C(1) | CC05CG391(4) | CCR05CG391(4)(1)(7) |
| 430.0 | C05(6)G431(4)1G5C(1) | CC05CG431(4) | CCR05CG431(4)(1)(7) |
| 470.0 | C05(6)G471(4)1G5C(1) | CC05CG471(4) | CCR05CG471(4)(1)(7) |
| 510.0 | C05(6)G511(4)1G5C(1) | CC05CG511(4) | CCR05CG511(4)(1)(7) |
| 560.0 | C05(6)G561(4)1G5C(1) | CC05CG561(4) | CCR05CG561(4)(1)(7) |
| 620.0 | C05(6)G621(4)1G5C(1) | CC05CG621(4) | CCR05CG621(4)(1)(7) |
| 680.0 | C05(6)G681(4)1G5C(1) | CC05CG681(4) | CCR05CG681(4)(1)(7) |
| 750.0 | C05(6)G751(4)1G5C(1) | CC05CG751(4) | CCR05CG751(4)(1)(7) |
| 820.0 | C05(6)G821(4)1G5C(1) | CC05CG821(4) | CCR05CG821(4)(1)(7) |
| 910.0 | C05(6)G911(4)1G5C(1) | CC05CG911(4) | CCR05CG911(4)(1)(7) |
| 1,000.0 | C05(6)G102(4)1G5C(1) | CC05CG102(4) | CCR05CG102(4)(1)(7) |
| 1,100.0 | C05(6)G112(4)1G5C(1) | CC05CG112(4) | CCR05CG112(4)(1)(7) |
| 1,200.0 | C05(6)G122(4)1G5C(1) | CC05CG122(4) | CCR05CG122(4)(1)(7) |
| 1,300.0 | C05(6)G132(4)1G5C(1) | CC05CG132(4) | CCR05CG132(4)(1)(7) |
| 1,500.0 | C05(6)G152(4)1G5C(1) | CC05CG152(4) | CCR05CG152(4)(1)(7) |
| 1,600.0 | C05(6)G162(4)1G5C(1) | CC05CG162(4) | CCR05CG162(4)(1)(7) |
| 1,800.0 | C05(6)G182(4)1G5C(1) | CC05CG182(4) | CCR05CG182(4)(1)(7) |
| 50 VOLT — C052/C056 SIZE (CC(R)05 PER MIL-PRF-20/35) | | | |
| 2,000.0 | C05(6)G202(4)5G5C(1) | CC05CG202(4) | CCR05CG202(4)(1)(7) |
| 2,200.0 | C05(6)G222(4)5G5C(1) | CC05CG222(4) | CCR05CG222(4)(1)(7) |
| 2,400.0 | C05(6)G242(4)5G5C(1) | CC05CG242(4) | CCR05CG242(4)(1)(7) |
| 2,700.0 | C05(6)G272(4)5G5C(1) | CC05CG272(4) | CCR05CG272(4)(1)(7) |
| 3,000.0 | C05(6)G302(4)5G5C(1) | CC05CG302(4) | CCR05CG302(4)(1)(7) |
| 3,300.0 | C05(6)G332(4)5G5C(1) | CC05CG332(4) | CCR05CG332(4)(1)(7) |

To complete Part Number, insert the following letters:

(1) Available Failure Rates: A (CC styles only); M, P, R & S (CCR styles only).

(2) Available Capacitance Tolerances: B, C.

(3) Available Capacitance Tolerances: B, C, D.

(4) Available Capacitance Tolerances: F, G, J, K.

(5) Available Capacitance Tolerances: F, G, J, K.

(6) Insert "2" for standard design, Style C052G
 Insert "6" for stand-off design, Style C056G } Stand-offs are available only as CCR's, not available as CC.

(7) Add "V" for stand-off design, Style C056G
 And leave blank for the flat bottom design (C052G)

RATINGS & PART NUMBER REFERENCE

| CAP. pF | KEMET PART NUMBER | MILITARY STYLE CC | MILITARY STYLE CCR |
|--|----------------------|-------------------|---------------------|
| 200 VOLT — C062/C066 SIZE (CC(R)06 PER MIL-PRF-20/36) | | | |
| 360.0 | C06(6)G361(4)2G5C(1) | CC06CG361(4) | CCR06CG361(4)(1)(7) |
| 390.0 | C06(6)G391(4)2G5C(1) | CC06CG391(4) | CCR06CG391(4)(1)(7) |
| 430.0 | C06(6)G431(4)2G5C(1) | CC06CG431(4) | CCR06CG431(4)(1)(7) |
| 470.0 | C06(6)G471(4)2G5C(1) | CC06CG471(4) | CCR06CG471(4)(1)(7) |
| 510.0 | C06(6)G511(4)2G5C(1) | CC06CG511(4) | CCR06CG511(4)(1)(7) |
| 560.0 | C06(6)G561(4)2G5C(1) | CC06CG561(4) | CCR06CG561(4)(1)(7) |
| 620.0 | C06(6)G621(4)2G5C(1) | CC06CG621(4) | CCR06CG621(4)(1)(7) |
| 680.0 | C06(6)G681(4)2G5C(1) | CC06CG681(4) | CCR06CG681(4)(1)(7) |
| 750.0 | C06(6)G751(4)2G5C(1) | CC06CG751(4) | CCR06CG751(4)(1)(7) |
| 820.0 | C06(6)G821(4)2G5C(1) | CC06CG821(4) | CCR06CG821(4)(1)(7) |
| 910.0 | C06(6)G911(4)2G5C(1) | CC06CG911(4) | CCR06CG911(4)(1)(7) |
| 1,000.0 | C06(6)G102(4)2G5C(1) | CC06CG102(4) | CCR06CG102(4)(1)(7) |
| 1,100.0 | C06(6)G112(4)2G5C(1) | CC06CG112(4) | CCR06CG112(4)(1)(7) |
| 1,200.0 | C06(6)G122(4)2G5C(1) | CC06CG122(4) | CCR06CG122(4)(1)(7) |
| 1,300.0 | C06(6)G132(4)2G5C(1) | CC06CG132(4) | CCR06CG132(4)(1)(7) |
| 1,500.0 | C06(6)G152(4)2G5C(1) | CC06CG152(4) | CCR06CG152(4)(1)(7) |
| 1,600.0 | C06(6)G162(4)2G5C(1) | CC06CG162(4) | CCR06CG162(4)(1)(7) |
| 1,800.0 | C06(6)G182(4)2G5C(1) | CC06CG182(4) | CCR06CG182(4)(1)(7) |
| 100 VOLT — C062/C066 SIZE (CC(R)06 PER MIL-PRF-20/36) | | | |
| 2,000.0 | C06(6)G202(4)1G5C(1) | CC06CG202(4) | CCR06CG202(4)(1)(7) |
| 2,200.0 | C06(6)G222(4)1G5C(1) | CC06CG222(4) | CCR06CG222(4)(1)(7) |
| 2,400.0 | C06(6)G242(4)1G5C(1) | CC06CG242(4) | CCR06CG242(4)(1)(7) |
| 2,700.0 | C06(6)G272(4)1G5C(1) | CC06CG272(4) | CCR06CG272(4)(1)(7) |
| 3,000.0 | C06(6)G302(4)1G5C(1) | CC06CG302(4) | CCR06CG302(4)(1)(7) |
| 3,300.0 | C06(6)G332(4)1G5C(1) | CC06CG332(4) | CCR06CG332(4)(1)(7) |
| 3,600.0 | C06(6)G362(4)1G5C(1) | CC06CG362(4) | CCR06CG362(4)(1)(7) |
| 3,900.0 | C06(6)G392(4)1G5C(1) | CC06CG392(4) | CCR06CG392(4)(1)(7) |
| 4,300.0 | C06(6)G432(4)1G5C(1) | CC06CG432(4) | CCR06CG432(4)(1)(7) |
| 4,700.0 | C06(6)G472(4)1G5C(1) | CC06CG472(4) | CCR06CG472(4)(1)(7) |
| 50 VOLT — C062/C066 SIZE (CC(R)06 PER MIL-PRF-20/36) | | | |
| 5,100.0 | C06(6)G512(5)5G5C(1) | CC06CG512(5) | CCR06CG512(5)(1)(7) |
| 5,600.0 | C06(6)G562(5)5G5C(1) | CC06CG562(5) | CCR06CG562(5)(1)(7) |
| 6,200.0 | C06(6)G622(5)5G5C(1) | CC06CG622(5) | CCR06CG622(5)(1)(7) |
| 6,800.0 | C06(6)G682(5)5G5C(1) | CC06CG682(5) | CCR06CG682(5)(1)(7) |
| 7,500.0 | C06(6)G752(5)5G5C(1) | CC06CG752(5) | CCR06CG752(5)(1)(7) |

- To complete Part Number, insert the following letters:
- (1) Available Failure Rates: A (CC styles only); M, P, R & S (CCR styles only).
 - (2) Available Capacitance Tolerances: B, C.
 - (3) Available Capacitance Tolerances: B, C, D.
 - (4) Available Capacitance Tolerances: F, G, J.
 - (5) Available Capacitance Tolerances: F, G, J, K.
 - (6) Insert "2" for standard design, Style C062G } Stand-offs are available
 - Insert "6" for stand-off design, Style C066G } only as CCR's, not available as CC.
 - (7) Add "V" for stand-off design, Style C066G
 - And leave blank for the flat bottom design (C062G)
 - (8) Available Capacitance Tolerances: G, J, K

| CAP. pF | KEMET PART NUMBER | MILITARY STYLE CC | MILITARY STYLE CCR |
|---|----------------------|-------------------|---------------------|
| 50 VOLT — C062/C066 SIZE (CC(R)06 PER MIL-PRF-20/36) | | | |
| 8,200.0 | C06(6)G822(5)5G5C(1) | CC06CG822(5) | CCR06CG822(5)(1)(7) |
| 9,100.0 | C06(6)G912(5)5G5C(1) | CC06CG912(5) | CCR06CG912(5)(1)(7) |
| 10,000.0 | C06(6)G103(5)5G5C(1) | CC06CG103(5) | CCR06CG103(5)(1)(7) |
| 12,000.0 | C06(6)G123(5)5G5C(1) | CC06CG123(5) | CCR06CG123(5)(1)(7) |
| 15,000.0 | C06(6)G153(5)5G5C(1) | CC06CG153(5) | CCR06CG153(5)(1)(7) |
| 18,000.0 | C06(6)G183(5)5G5C(1) | CC06CG183(5) | CCR06CG183(5)(1)(7) |
| 200 VOLT — C512 SIZE (CC(R)07 PER MIL-PRF-20/37) | | | |
| 2,200.0 | C512G222(5)2G5C(1) | CC07CG222(5) | CCR07CG222(5)(1) |
| 2,700.0 | C512G272(5)2G5C(1) | CC07CG272(5) | CCR07CG272(5)(1) |
| 3,300.0 | C512G332(5)2G5C(1) | CC07CG332(5) | CCR07CG332(5)(1) |
| 3,900.0 | C512G392(5)2G5C(1) | CC07CG392(5) | CCR07CG392(5)(1) |
| 4,700.0 | C512G472(5)2G5C(1) | CC07CG472(5) | CCR07CG472(5)(1) |
| 100 VOLT — C512 SIZE (CC(R)07 PER MIL-PRF-20/37) | | | |
| 5,600.0 | C512G562(5)1G5C(1) | CC07CG562(5) | CCR07CG562(5)(1) |
| 6,800.0 | C512G682(5)1G5C(1) | CC07CG682(5) | CCR07CG682(5)(1) |
| 8,200.0 | C512G822(5)1G5C(1) | CC07CG822(5) | CCR07CG822(5)(1) |
| 10,000.0 | C512G103(5)1G5C(1) | CC07CG103(5) | CCR07CG103(5)(1) |
| 12,000.0 | C512G123(5)1G5C(1) | CC07CG123(5) | CCR07CG123(5)(1) |
| 50 VOLT — C512 SIZE (CC(R)07 PER MIL-PRF-20/37) | | | |
| 15,000.0 | C512G153(5)5G5C(1) | CC07CG153(5) | CCR07CG153(5)(1) |
| 18,000.0 | C512G183(5)5G5C(1) | CC07CG183(5) | CCR07CG183(5)(1) |
| 22,000.0 | C512G223(5)5G5C(1) | CC07CG223(5) | CCR07CG223(5)(1) |
| 27,000.0 | C512G273(5)5G5C(1) | CC07CG273(5) | CCR07CG273(5)(1) |
| 33,000.0 | C512G333(5)5G5C(1) | CC07CG333(5) | CCR07CG333(5)(1) |
| 39,000.0 | C512G393(5)5G5C(1) | CC07CG393(5) | CCR07CG393(5)(1) |
| 47,000.0 | C512G473(5)5G5C(1) | CC07CG473(5) | CCR07CG473(5)(1) |
| 56,000.0 | C512G563(5)5G5C(1) | CC07CG563(5) | CCR07CG563(5)(1) |
| 68,000.0 | C512G683(5)5G5C(1) | CC07CG683(5) | CCR07CG683(5)(1) |
| 83,000.0 | C512G823(5)5G5C(1) | CC07CG823(5) | CCR07CG823(5)(1) |
| 100,000.0 | C512G104(5)5G5C(1) | CC07CG104(5) | CCR07CG104(5)(1) |
| 200 VOLT — C522 SIZE (CC(R)08 PER MIL-PRF-20/38) | | | |
| 3,900.0 | C522G392(8)2G5C(1) | CC08CG392(8) | CCR08CG392(8)(1) |
| 4,700.0 | C522G472(8)2G5C(1) | CC08CG472(8) | CCR08CG472(8)(1) |
| 100 VOLT — C522 SIZE (CC(R)08 PER MIL-PRF-20/38) | | | |
| 15,000.0 | C522G153(8)1G5C(1) | CC08CG153(8) | CCR08CG153(8)(1) |
| 18,000.0 | C522G183(8)1G5C(1) | CC08CG183(8) | CCR08CG183(8)(1) |
| 50 VOLT — C522 SIZE (CC(R)08 PER MIL-PRF-20/38) | | | |
| 56,000.0 | C522G563(8)5G5C(1) | CC08CG563(8) | CCR08CG563(8)(1) |
| 68,000.0 | C522G683(8)5G5C(1) | CC08CG683(8) | CCR08CG683(8)(1) |

MIL-PRF-20

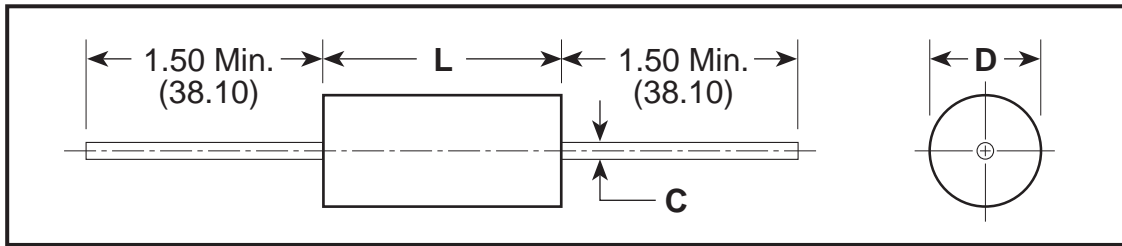
CAPACITOR OUTLINE DRAWINGS (AXIAL LEADS)

DIMENSIONS – INCHES & (MILLIMETERS)

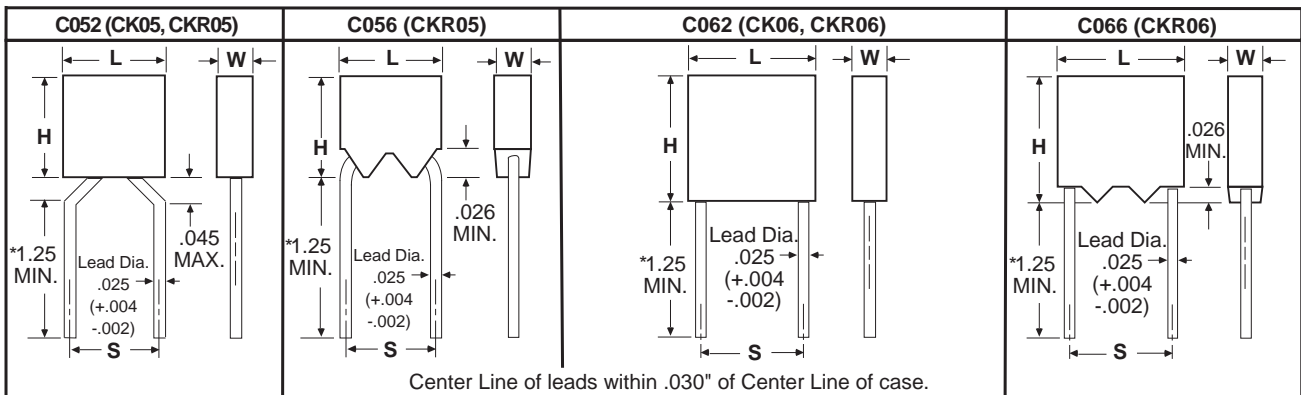
| CASE SIZE | MILITARY EQUIVALENT STYLES | L | D | C |
|-----------|----------------------------|---------------------------|--------------------------|--------------------------------------|
| C114 | CK12, CKR11 | .160 ± .010 (4.06 ± .25) | .090 ± .010 (2.29 ± .25) | .020, +.000, -.003 (.51, +.00, -.08) |
| C124 | CK13, CKR12 | .250 ± .010 (6.35 ± .25) | .090 ± .010 (2.29 ± .25) | .020, +.000, -.003 (.51, +.00, -.08) |
| C192 | CK14, CKR14 | .390 ± .010 (9.91 ± .25) | .140 ± .010 (3.56 ± .25) | .025, +.002, -.002 (.64, +.05, -.05) |
| C202 | CK15, CKR15 | .500 ± .020 (12.70 ± .51) | .250 ± .015 (6.35 ± .38) | .025, +.002, -.002 (.64, +.05, -.05) |
| C222 | CK16, CKR16 | .690 ± .030 (17.53 ± .76) | .350 ± .020 (8.89 ± .51) | .025, +.002, -.002 (.64, +.05, -.05) |

CAPACITOR OUTLINE DRAWINGS (RADIAL LEADS)

* Leads are .625 minimum when tape and reel packaged.

DIMENSIONS – INCHES & (MILLIMETERS)

| CASE SIZE | MILITARY EQUIVALENT STYLES | H HEIGHT | L LENGTH | W WIDTH | S LEAD SPACING |
|---------------|----------------------------|--------------------------|--------------------------|--------------------------|--------------------------|
| C052/ C056 | CK05, CKR05 | .190 ± .010 (4.83 ± .25) | .190 ± .010 (4.83 ± .25) | .090 ± .010 (2.29 ± .25) | .200 ± .015 (5.08 ± .38) |
| C062/ C066 | CK06, CKR06 | .290 ± .010 (7.37 ± .25) | .290 ± .010 (7.37 ± .25) | .090 ± .010 (2.29 ± .25) | .200 ± .015 (5.08 ± .38) |

ORDERING INFORMATION

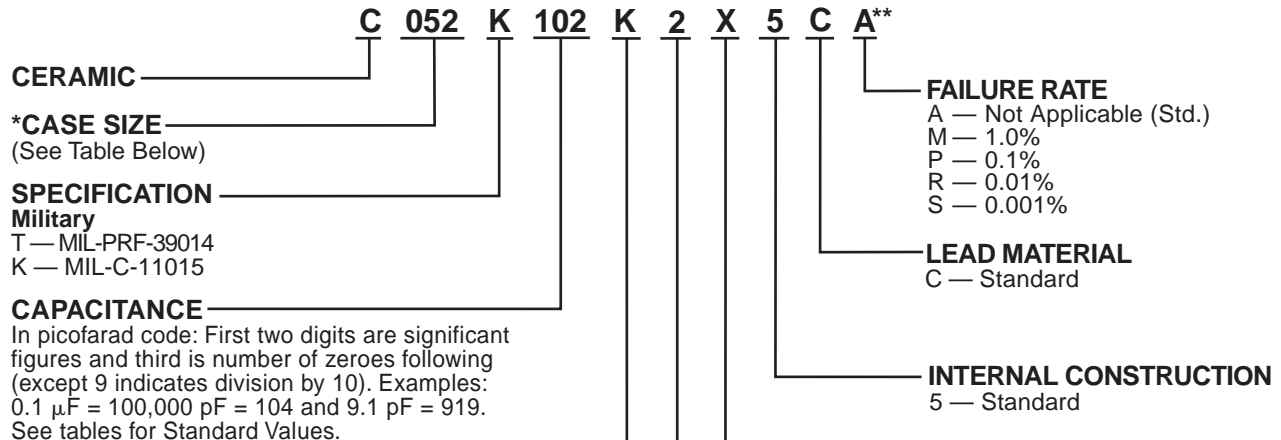

CAPACITANCE TOLERANCE
Standard
M — \pm 20%
K — \pm 10%

Standard tolerances for each Series are shown in the repetitive parts lists.

| *CASE SIZES | |
|-------------|-------|
| RADIAL | AXIAL |
| C052 | C114 |
| C056 | C124 |
| C062 | C192 |
| C066 | C202 |
| | C222 |

| TEMPERATURE CHARACTERISTIC | | | | | |
|----------------------------|---------------------|----------------|-----------------|----------------------------------|------------------------------------|
| KEMET Designator | Military Equivalent | EIA Equivalent | Temp. Range, °C | Capacitance Change With Temp. | |
| | | | | Measured Without DC Bias Voltage | Measured With Bias (Rated Voltage) |
| X (Stable) | BX | X7R | -55 to +125 | \pm 15% | +15% -25% |
| R (Stable) | BR | X7R | -55 to +125 | \pm 15% | +15% -40% |

**Part Number Example: C052K102K2X5CA (14 digits – no spaces)

MARKING INFORMATION

C114T (CKR11) THROUGH C222T (CKR16) PER MIL-PRF-39014

C114T (CKR11)

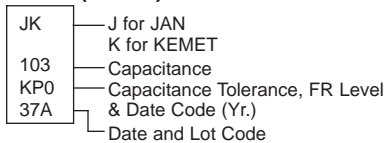

C124T (CKR12)

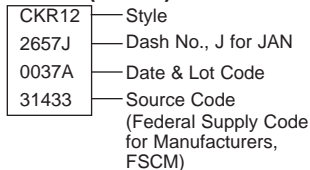

C192T (CKR14) C202T (CKR15) C222T (CKR16)

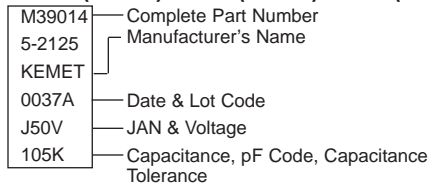

C052/56T (CKR05) PER MIL-PRF-39014/01

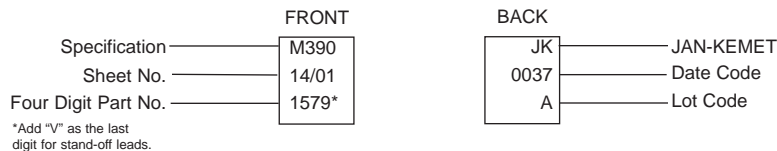

C062/66T (CKR06) PER MIL-PRF-39014/02

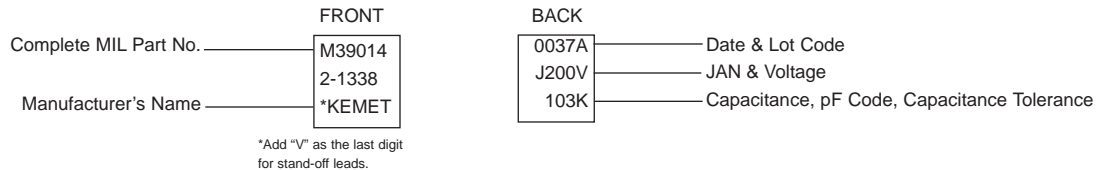

C114K (CK12) THROUGH C222K (CK16) PER MIL-C-11015

C114K (CK12) C124K (CK13)

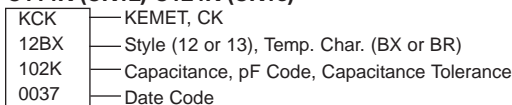

C192K (CK14) C202K (CK15) C222K (CK16)

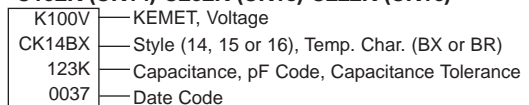

C052K (CK05) PER MIL-C-11015/18 & C062K (CK06) PER MIL-C-11015/19

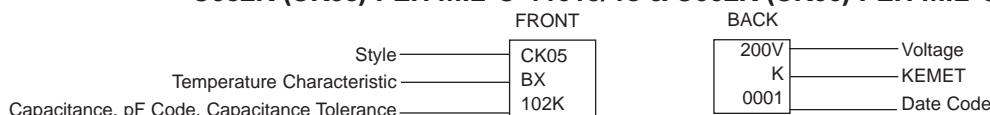

MIL-C-11015
MIL-PRF-39014

RATINGS & PART NUMBER REFERENCE

| CAP. pF | TOL. % | KEMET PART NUMBER | MIL-C-11015/20 | MIL-PRF-39014/05 | MIL-PRF-39014/05 For Failure Rate Levels (2) | | | |
|--|-----------|----------------------|----------------|------------------|--|------|------|------|
| | | | | | M | P | R | S |
| 100 VOLT — C114 SIZE (MILITARY—CK12 or CKR11) | | | | | | | | |
| 10 | 10 | C114(1)100K1X5C(2) | CK12BX100K | CKR11BX100K(2) | 2601 | 2801 | 2001 | 2201 |
| 10 | 20 | C114(1)100M1X5C(2) | CK12BX100M | CKR11BX100M(2) | 2602 | 2802 | 2002 | 2202 |
| 12 | 10 | C114(1)120K1X5C(2) | CK12BX120K | CKR11BX120K(2) | 2603 | 2803 | 2003 | 2203 |
| 15 | 10 | C114(1)150K1X5C(2) | CK12BX150K | CKR11BX150K(2) | 2604 | 2804 | 2004 | 2204 |
| 15 | 20 | C114(1)150M1X5C(2) | CK12BX150M | CKR11BX150M(2) | 2605 | 2805 | 2005 | 2205 |
| 18 | 10 | C114(1)180K1X5C(2) | CK12BX180K | CKR11BX180K(2) | 2606 | 2806 | 2006 | 2206 |
| 22 | 10 | C114(1)220K1X5C(2) | CK12BX220K | CKR11BX220K(2) | 2607 | 2807 | 2007 | 2207 |
| 22 | 20 | C114(1)220M1X5C(2) | CK12BX220M | CKR11BX220M(2) | 2608 | 2808 | 2008 | 2208 |
| 27 | 10 | C114(1)270K1X5C(2) | CK12BX270K | CKR11BX270K(2) | 2609 | 2809 | 2009 | 2209 |
| 33 | 10 | C114(1)330K1X5C(2) | CK12BX330K | CKR11BX330K(2) | 2610 | 2810 | 2010 | 2210 |
| 33 | 20 | C114(1)330M1X5C(2) | CK12BX330M | CKR11BX330M(2) | 2611 | 2811 | 2011 | 2211 |
| 39 | 10 | C114(1)390K1X5C(2) | CK12BX390K | CKR11BX390K(2) | 2612 | 2812 | 2012 | 2212 |
| 47 | 10 | C114(1)470K1X5C(2) | CK12BX470K | CKR11BX470K(2) | 2613 | 2813 | 2013 | 2213 |
| 47 | 20 | C114(1)470M1X5C(2) | CK12BX470M | CKR11BX470M(2) | 2614 | 2814 | 2014 | 2214 |
| 56 | 10 | C114(1)560K1X5C(2) | CK12BX560K | CKR11BX560K(2) | 2615 | 2815 | 2015 | 2215 |
| 68 | 10 | C114(1)680K1X5C(2) | CK12BX680K | CKR11BX680K(2) | 2616 | 2816 | 2016 | 2216 |
| 68 | 20 | C114(1)680M1X5C(2) | CK12BX680M | CKR11BX680M(2) | 2617 | 2817 | 2017 | 2217 |
| 82 | 10 | C114(1)820K1X5C(2) | CK12BX820K | CKR11BX820K(2) | 2618 | 2818 | 2018 | 2218 |
| 100 | 10 | C114(1)101K1X5C(2) | CK12BX101K | CKR11BX101K(2) | 2619 | 2819 | 2019 | 2219 |
| 100 | 20 | C114(1)101M1X5C(2) | CK12BX101M | CKR11BX101M(2) | 2620 | 2820 | 2020 | 2220 |
| 120 | 10 | C114(1)121K1X5C(2) | CK12BX121K | CKR11BX121K(2) | 2621 | 2821 | 2021 | 2221 |
| 150 | 10 | C114(1)151K1X5C(2) | CK12BX151K | CKR11BX151K(2) | 2622 | 2822 | 2022 | 2222 |
| 150 | 20 | C114(1)151M1X5C(2) | CK12BX151M | CKR11BX151M(2) | 2623 | 2823 | 2023 | 2223 |
| 180 | 10 | C114(1)181K1X5C(2) | CK12BX181K | CKR11BX181K(2) | 2624 | 2824 | 2024 | 2224 |
| 220 | 10 | C114(1)221K1X5C(2) | CK12BX221K | CKR11BX221K(2) | 2625 | 2825 | 2025 | 2225 |
| 220 | 20 | C114(1)221M1X5C(2) | CK12BX221M | CKR11BX221M(2) | 2626 | 2826 | 2026 | 2226 |
| 270 | 10 | C114(1)271K1X5C(2) | CK12BX271K | CKR11BX271K(2) | 2627 | 2827 | 2027 | 2227 |
| 330 | 10 | C114(1)331K1X5C(2) | CK12BX331K | CKR11BX331K(2) | 2628 | 2828 | 2028 | 2228 |
| 330 | 20 | C114(1)331M1X5C(2) | CK12BX331M | CKR11BX331M(2) | 2629 | 2829 | 2029 | 2229 |
| 390 | 10 | C114(1)391K1X5C(2) | CK12BX391K | CKR11BX391K(2) | 2630 | 2830 | 2030 | 2230 |
| 470 | 10 | C114(1)471K1X5C(2) | CK12BX471K | CKR11BX471K(2) | 2631 | 2831 | 2031 | 2231 |
| 470 | 20 | C114(1)471M1X5C(2) | CK12BX471M | CKR11BX471M(2) | 2632 | 2832 | 2032 | 2232 |
| 560 | 10 | C114(1)561K1X5C(2) | CK12BX561K | CKR11BX561K(2) | 2633 | 2833 | 2033 | 2233 |
| 680 | 10 | C114(1)681K1X5C(2) | CK12BX681K | CKR11BX681K(2) | 2634 | 2834 | 2034 | 2234 |
| 680 | 20 | C114(1)681M1X5C(2) | CK12BX681M | CKR11BX681M(2) | 2635 | 2835 | 2035 | 2235 |
| 820 | 10 | C114(1)821K1X5C(2) | CK12BX821K | CKR11BX821K(2) | 2636 | 2836 | 2036 | 2236 |
| 1,000 | 10 | C114(1)102K1X5C(2) | CK12BX102K | CKR11BX102K(2) | 2637 | 2837 | 2037 | 2237 |
| 1,000 | 20 | C114(1)102M1X5C(2) | CK12BX102M | CKR11BX102M(2) | 2638 | 2838 | 2038 | 2238 |
| 1,200 | 10 | C114(1)122K1X5C(2) | CK12BX122K | CKR11BX122K(2) | 2639 | 2839 | 2039 | 2239 |
| 1,500 | 10 | C114(1)152K1X5C(2) | CK12BX152K | CKR11BX152K(2) | 2640 | 2840 | 2040 | 2240 |
| 1,500 | 20 | C114(1)152M1X5C(2) | CK12BX152M | CKR11BX152M(2) | 2641 | 2841 | 2041 | 2241 |
| 1,800 | 10 | C114(1)182K1X5C(2) | CK12BX182K | CKR11BX182K(2) | 2642 | 2842 | 2042 | 2242 |
| 2,200 | 10 | C114(1)222K1X5C(2) | CK12BX222K | CKR11BX222K(2) | 2643 | 2843 | 2043 | 2243 |
| 2,200 | 20 | C114(1)222M1X5C(2) | CK12BX222M | CKR11BX222M(2) | 2644 | 2844 | 2044 | 2244 |
| 2,700 | 10 | C114(1)272K1X5C(2) | CK12BX272K | CKR11BX272K(2) | 2645 | 2845 | 2045 | 2245 |
| 3,300 | 10 | C114(1)332K1X5C(2) | CK12BX332K | CKR11BX332K(2) | 2646 | 2846 | 2046 | 2246 |
| 3,300 | 20 | C114(1)332M1X5C(2) | CK12BX332M | CKR11BX332M(2) | 2647 | 2847 | 2047 | 2247 |
| 3,900 | 10 | C114(1)392K1X5C(2) | CK12BX392K | CKR11BX392K(2) | 2648 | 2848 | 2048 | 2248 |
| 4,700 | 10 | C114(1)472K1X5C(2) | CK12BX472K | CKR11BX472K(2) | 2649 | 2849 | 2049 | 2249 |
| 4,700 | 20 | C114(1)472M1X5C(2) | CK12BX472M | CKR11BX472M(2) | 2650 | 2850 | 2050 | 2250 |
| 50 VOLT — C114 SIZE (MILITARY—CK12 or CKR11) | | | | | | | | |
| 5,600 | 10 | C114(1)562K5X5C(2) | CK12BX562K | CKR11BX562K(2) | 2651 | 2851 | 2051 | 2251 |
| 6,800 | 10 | C114(1)682K5X5C(2) | CK12BX682K | CKR11BX682K(2) | 2652 | 2852 | 2052 | 2252 |
| 6,800 | 20 | C114(1)682M5X5C(2) | CK12BX682M | CKR11BX682M(2) | 2653 | 2853 | 2053 | 2253 |
| 8,200 | 10 | C114(1)822K5X5C(2) | CK12BX822K | CKR11BX822K(2) | 2654 | 2854 | 2054 | 2254 |
| 10,000 | 10 | C114(1)103K5X5C(2) | CK12BX103K | CKR11BX103K(2) | 2655 | 2855 | 2055 | 2255 |
| 10,000 | 20 | C114(1)103M5X5C(2) | CK12BX103M | CKR11BX103M(2) | 2656 | 2856 | 2056 | 2256 |
| 100 VOLT — C124 SIZE (MILITARY—CK13 or CKR12) | | | | | | | | |
| 5,600 | 10 | C124(1)562K1X5C(2) | CK13BX562K | CKR12BX562K(2) | 2657 | 2857 | 2057 | 2257 |
| 6,800 | 10 | C124(1)682K1X5C(2) | CK13BX682K | CKR12BX682K(2) | 2658 | 2858 | 2058 | 2258 |
| 6,800 | 20 | C124(1)682M1X5C(2) | CK13BX682M | CKR12BX682M(2) | 2659 | 2859 | 2059 | 2259 |
| 8,200 | 10 | C124(1)822K1X5C(2) | CK13BX822K | CKR12BX822K(2) | 2660 | 2860 | 2060 | 2260 |
| 10,000 | 10 | C124(1)103K1X5C(2) | CK13BX103K | CKR12BX103K(2) | 2661 | 2861 | 2061 | 2261 |
| 10,000 | 20 | C124(1)103M1X5C(2) | CK13BX103M | CKR12BX103M(2) | 2662 | 2862 | 2062 | 2262 |
| 50 VOLT — C124 SIZE (MILITARY—CK13 or CKR12) | | | | | | | | |
| 12,000 | 10 | C124(1)123K5X5C(2) | CK13BX123K | CKR12BX123K(2) | 2663 | 2863 | 2063 | 2263 |
| 15,000 | 10 | C124(1)153K5X5C(2) | CK13BX153K | CKR12BX153K(2) | 2664 | 2864 | 2064 | 2264 |
| 15,000 | 20 | C124(1)153M5X5C(2) | CK13BX153M | CKR12BX153M(2) | 2665 | 2865 | 2065 | 2265 |
| 18,000 | 10 | C124(1)183K5X5C(2) | CK13BX183K | CKR12BX183K(2) | 2666 | 2866 | 2066 | 2266 |
| 22,000 | 10 | C124(1)223K5X5C(2) | CK13BX223K | CKR12BX223K(2) | 2667 | 2867 | 2067 | 2267 |
| 22,000 | 20 | C124(1)223M5X5C(2) | CK13BX223M | CKR12BX223M(2) | 2668 | 2868 | 2068 | 2268 |
| 27,000 | 10 | C124K273K5R5CA | CK13BR273K | | | | | |
| 33,000 | 10 | C124K333K5R5CA | CK13BR333K | | | | | |
| 33,000 | 20 | C124K333M5R5CA | CK13BR333M | | | | | |
| 39,000 | 10 | C124K393K5R5CA | CK13BR393K | | | | | |
| 47,000 | 10 | C124K473K5R5CA | CK13BR473K | | | | | |
| 47,000 | 20 | C124K473M5R5CA | CK13BR473M | | | | | |

(1) Insert proper letter for specification: K — MIL-C-11015; T — MIL-PRF-39014 (2) Failure Rate Designator: A — Not applicable (MIL-C-11015); M — 1%/1000 Hours, P — .1%/1000 Hours, R — .01%/1000 Hours, S — .001%/1000 Hours (MIL-PRF-39014)

RATINGS & PART NUMBER REFERENCE

| CAP. pF | TOL. % | KEMET PART NUMBER | MIL-C-11015/20 | MIL-PRF-39014/05 | MIL-PRF-39014/05 For Failure Rate Levels (2) | | | |
|--|-----------|----------------------|----------------|------------------|--|------|------|------|
| | | | | | M | P | R | S |
| 50 VOLT — C124 SIZE (MILITARY—CK13 or CKR12) (Cont'd) | | | | | | | | |
| 27,000 | 10 | C124T273K5X5C(2) | | CKR12BX273K(2) | 2669 | 2869 | 2069 | 2269 |
| 33,000 | 10 | C124T333K5X5C(2) | | CKR12BX333K(2) | 2670 | 2870 | 2070 | 2270 |
| 33,000 | 20 | C124T333M5X5C(2) | | CKR12BX333M(2) | 2671 | 2871 | 2071 | 2271 |
| 39,000 | 10 | C124T393K5X5C(2) | | CKR12BX393K(2) | 2672 | 2872 | 2072 | 2272 |
| 47,000 | 10 | C124T473K5X5C(2) | | CKR12BX473K(2) | 2673 | 2873 | 2073 | 2273 |
| 47,000 | 20 | C124T473M5X5C(2) | | CKR12BX473M(2) | 2674 | 2874 | 2074 | 2274 |
| 100 VOLT — C192 SIZE (MILITARY—CK14 or CKR14) | | | | | | | | |
| 12,000 | 10 | C192(1)123K1X5C(2) | CK14BX123K | CKR14BX123K(2) | 2675 | 2875 | 2075 | 2275 |
| 15,000 | 10 | C192(1)153K1X5C(2) | CK14BX153K | CKR14BX153K(2) | 2676 | 2876 | 2076 | 2276 |
| 15,000 | 20 | C192(1)153M1X5C(2) | CK14BX153M | CKR14BX153M(2) | 2677 | 2877 | 2077 | 2277 |
| 18,000 | 10 | C192(1)183K1X5C(2) | CK14BX183K | CKR14BX183K(2) | 2678 | 2878 | 2078 | 2278 |
| 22,000 | 10 | C192(1)223K1X5C(2) | CK14BX223K | CKR14BX223K(2) | 2679 | 2879 | 2079 | 2279 |
| 22,000 | 20 | C192(1)223M1X5C(2) | CK14BX223M | CKR14BX223M(2) | 2680 | 2880 | 2080 | 2280 |
| 27,000 | 10 | C192(1)273K1X5C(2) | CK14BX273K | CKR14BX273K(2) | 2681 | 2881 | 2081 | 2281 |
| 33,000 | 10 | C192(1)333K1X5C(2) | CK14BX333K | CKR14BX333K(2) | 2682 | 2882 | 2082 | 2282 |
| 33,000 | 20 | C192(1)333M1X5C(2) | CK14BX333M | CKR14BX333M(2) | 2683 | 2883 | 2083 | 2283 |
| 39,000 | 10 | C192(1)393K1X5C(2) | CK14BX393K | CKR14BX393K(2) | 2684 | 2884 | 2084 | 2284 |
| 47,000 | 10 | C192(1)473K1X5C(2) | CK14BX473K | CKR14BX473K(2) | 2685 | 2885 | 2085 | 2285 |
| 47,000 | 20 | C192(1)473M1X5C(2) | CK14BX473M | CKR14BX473M(2) | 2686 | 2886 | 2086 | 2286 |
| 56,000 | 10 | C192(1)563K1R5C(2) | CK14BR563K | CKR14BR563K(2) | 2693 | 2893 | 2093 | 2293 |
| 68,000 | 10 | C192(1)683K1R5C(2) | CK14BR683K | CKR14BR683K(2) | 2694 | 2894 | 2094 | 2294 |
| 68,000 | 20 | C192(1)683M1R5C(2) | CK14BR683M | CKR14BR683M(2) | 2695 | 2895 | 2095 | 2295 |
| 82,000 | 10 | C192(1)823K1R5C(2) | CK14BR823K | CKR14BR823K(2) | 2696 | 2896 | 2096 | 2296 |
| 100,000 | 10 | C192(1)104K1R5C(2) | CK14BR104K | CKR14BR104K(2) | 2697 | 2897 | 2097 | 2297 |
| 100,000 | 20 | C192(1)104M1R5C(2) | CK14BR104M | CKR14BR104M(2) | 2698 | 2898 | 2098 | 2298 |
| 50 VOLT — C192 SIZE (MILITARY—CK14 or CKR14) | | | | | | | | |
| 56,000 | 10 | C192T563K5X5C(2) | | CKR14BX563K(2) | 2687 | 2887 | 2087 | 2287 |
| 68,000 | 10 | C192T683K5X5C(2) | | CKR14BX683K(2) | 2688 | 2888 | 2088 | 2288 |
| 68,000 | 20 | C192T683M5X5C(2) | | CKR14BX683M(2) | 2689 | 2889 | 2089 | 2289 |
| 82,000 | 10 | C192T823K5X5C(2) | | CKR14BX823K(2) | 2690 | 2890 | 2090 | 2290 |
| 100,000 | 10 | C192T104K5X5C(2) | | CKR14BX104K(2) | 2691 | 2891 | 2091 | 2291 |
| 100,000 | 20 | C192T104M5X5C(2) | | CKR14BX104M(2) | 2692 | 2892 | 2092 | 2292 |
| 120,000 | 10 | C192(1)124K5R5C(2) | CK14BR124K | CKR14BR124K(2) | 2699 | 2899 | 2099 | 2299 |
| 150,000 | 10 | C192(1)154K5R5C(2) | CK14BR154K | CKR14BR154K(2) | 2700 | 2900 | 2100 | 2300 |
| 150,000 | 20 | C192(1)154M5R5C(2) | CK14BR154M | CKR14BR154M(2) | 2701 | 2901 | 2101 | 2301 |
| 180,000 | 10 | C192(1)184K5R5C(2) | CK14BR184K | CKR14BR184K(2) | 2702 | 2902 | 2102 | 2302 |
| 220,000 | 10 | C192(1)224K5R5C(2) | CK14BR224K | CKR14BR224K(2) | 2703 | 2903 | 2103 | 2303 |
| 220,000 | 20 | C192(1)224M5R5C(2) | CK14BR224M | CKR14BR224M(2) | 2704 | 2904 | 2104 | 2304 |
| 270,000 | 10 | C192(1)274K5R5C(2) | CK14BR274K | CKR14BR274K(2) | 2705 | 2905 | 2105 | 2305 |
| 100 VOLT — C202 SIZE (MILITARY—CK15 or CKR15) | | | | | | | | |
| 56,000 | 10 | C202T563K1X5C(2) | | CKR15BX563K(2) | 2706 | 2906 | 2106 | 2306 |
| 68,000 | 10 | C202T683K1X5C(2) | | CKR15BX683K(2) | 2707 | 2907 | 2107 | 2307 |
| 68,000 | 20 | C202T683M1X5C(2) | | CKR15BX683M(2) | 2708 | 2908 | 2108 | 2308 |
| 82,000 | 10 | C202T823K1X5C(2) | | CKR15BX823K(2) | 2709 | 2909 | 2109 | 2309 |
| 100,000 | 10 | C202(1)104K1X5C(2) | CK15BX104K | CKR15BX104K(2) | 2710 | 2910 | 2110 | 2310 |
| 100,000 | 20 | C202(1)104M1X5C(2) | CK15BX104M | CKR15BX104M(2) | 2711 | 2911 | 2111 | 2311 |
| 120,000 | 10 | C202(1)124K1R5C(2) | CK15BR124K | CKR15BR124K(2) | 2712 | 2912 | 2112 | 2312 |
| 150,000 | 10 | C202(1)154K1R5C(2) | CK15BR154K | CKR15BR154K(2) | 2713 | 2913 | 2113 | 2313 |
| 150,000 | 20 | C202(1)154M1R5C(2) | CK15BR154M | CKR15BR154M(2) | 2714 | 2914 | 2114 | 2314 |
| 180,000 | 10 | C202(1)184K1R5C(2) | CK15BR184K | CKR15BR184K(2) | 2715 | 2915 | 2115 | 2315 |
| 220,000 | 10 | C202(1)224K1R5C(2) | CK15BR224K | CKR15BR224K(2) | 2716 | 2916 | 2116 | 2316 |
| 220,000 | 20 | C202(1)224M1R5C(2) | CK15BR224M | CKR15BR224M(2) | 2717 | 2917 | 2117 | 2317 |
| 270,000 | 10 | C202(1)274K1R5C(2) | CK15BR274K | CKR15BR274K(2) | 2718 | 2918 | 2118 | 2318 |
| 330,000 | 10 | C202(1)334K1R5C(2) | CK15BR334K | CKR15BR334K(2) | 2719 | 2919 | 2119 | 2319 |
| 330,000 | 20 | C202(1)334M1R5C(2) | CK15BR334M | CKR15BR334M(2) | 2720 | 2920 | 2120 | 2320 |
| 50 VOLT — C202 SIZE (MILITARY—CK15 or CKR15) | | | | | | | | |
| 470,000 | 10 | C202(1)474K5R5C(2) | CK15BR474K | CKR15BR474K(2) | 2721 | 2921 | 2121 | 2321 |
| 470,000 | 20 | C202(1)474M5R5C(2) | CK15BR474M | CKR15BR474M(2) | 2722 | 2922 | 2122 | 2322 |
| 680,000 | 10 | C202T684K5R5C(2) | | CKR15BR684K(2) | 2723 | 2923 | 2123 | 2323 |
| 680,000 | 20 | C202T684M5R5C(2) | | CKR15BR684M(2) | 2724 | 2924 | 2124 | 2324 |
| 1,000,000 | 10 | C202(1)105K5R5C(2) | CK15BR105K | CKR15BR105K(2) | 2725 | 2925 | 2125 | 2325 |
| 1,000,000 | 20 | C202(1)105M5R5C(2) | CK15BR105M | CKR15BR105M(2) | 2726 | 2926 | 2126 | 2326 |
| 100 VOLT — C222 SIZE (MILITARY—CK16 or CKR16) | | | | | | | | |
| 470,000 | 10 | C222(1)474K1R5C(2) | CK16BR474K | CKR16BR474K(2) | 2727 | 2927 | 2127 | 2327 |
| 470,000 | 20 | C222(1)474M1R5C(2) | CK16BR474M | CKR16BR474M(2) | 2728 | 2928 | 2128 | 2328 |
| 680,000 | 10 | C222T684K1R5C(2) | | CKR16BR684K(2) | 2729 | 2929 | 2129 | 2329 |
| 680,000 | 20 | C222T684M1R5C(2) | | CKR16BR684M(2) | 2730 | 2930 | 2130 | 2330 |
| 1,000,000 | 10 | C222(1)105K1R5C(2) | CK16BR105K | CKR16BR105K(2) | 2731 | 2931 | 2131 | 2331 |
| 1,000,000 | 20 | C222(1)105M1R5C(2) | CK16BR105M | CKR16BR105M(2) | 2732 | 2932 | 2132 | 2332 |
| 50 VOLT — C222 SIZE (MILITARY—CK16 or CKR16) | | | | | | | | |
| 2,200,000 | 10 | C222(1)225K5R5C(2) | CK16BR225K | CKR16BR225K(2) | 2733 | 2933 | 2133 | 2333 |
| 2,200,000 | 20 | C222(1)225M5R5C(2) | CK16BR225M | CKR16BR225M(2) | 2734 | 2934 | 2134 | 2334 |
| 3,300,000 | 10 | C222(1)335K5R5C(2) | CK16BR335K | CKR16BR335K(2) | 2735 | 2935 | 2135 | 2335 |
| 3,300,000 | 20 | C222(1)335M5R5C(2) | CK16BR335M | CKR16BR335M(2) | 2736 | 2936 | 2136 | 2336 |

MIL-C-11015
MIL-PRF-39014

(1) Insert proper letter for specification: K — MIL-C-11015; T — MIL-PRF-39014 (2) Failure Rate Designator: A — Not applicable (MIL-C-11015); M — 1%/1000 Hours, P — .1%/1000 Hours, R — .01%/1000 Hours, S — .001%/1000 Hours (MIL-PRF-39014)



CERAMIC MOLDED/RADIAL — MIL-C-11015 & MIL-PRF-39014

STABLE TEMPERATURE CHARACTERISTICS—BX & BR (EIA-X7R)

RATINGS & PART NUMBER REFERENCE

| CAP. pF | TOL. % | KEMET PART NUMBER | MIL-C-11015/18 | MIL-PRF-39014/01 | MIL-PRF-39014/01 For Failure Rate Levels (2) | | | |
|---|-----------|----------------------|----------------|-------------------|--|---------|---------|---------|
| | | | | | M | P | R | S |
| 200 VOLT — C052/C056 SIZE (MILITARY — CK05 or CKR05) | | | | | | | | |
| 10 | 10 | C05(4)(1)100K2X5C(2) | CK05BX100K | CKR05BX100K(2)(3) | 1201(3) | 1241(3) | 1281(3) | 1321(3) |
| 10 | 20 | C05(4)(1)100M2X5C(2) | CK05BX100M | CKR05BX100M(2)(3) | 1202(3) | 1242(3) | 1282(3) | 1322(3) |
| 12 | 10 | C05(4)(1)120K2X5C(2) | CK05BX120K | CKR05BX120K(2)(3) | 1203(3) | 1243(3) | 1283(3) | 1323(3) |
| 15 | 10 | C05(4)(1)150K2X5C(2) | CK05BX150K | CKR05BX150K(2)(3) | 1204(3) | 1244(3) | 1284(3) | 1324(3) |
| 15 | 20 | C05(4)(1)150M2X5C(2) | CK05BX150M | CKR05BX150M(2)(3) | 1205(3) | 1245(3) | 1285(3) | 1325(3) |
| 18 | 10 | C05(4)(1)180K2X5C(2) | CK05BX180K | CKR05BX180K(2)(3) | 1206(3) | 1246(3) | 1286(3) | 1326(3) |
| 22 | 10 | C05(4)(1)220K2X5C(2) | CK05BX220K | CKR05BX220K(2)(3) | 1207(3) | 1247(3) | 1287(3) | 1327(3) |
| 22 | 20 | C05(4)(1)220M2X5C(2) | CK05BX220M | CKR05BX220M(2)(3) | 1208(3) | 1248(3) | 1288(3) | 1328(3) |
| 27 | 10 | C05(4)(1)270K2X5C(2) | CK05BX270K | CKR05BX270K(2)(3) | 1209(3) | 1249(3) | 1289(3) | 1329(3) |
| 33 | 10 | C05(4)(1)330K2X5C(2) | CK05BX330K | CKR05BX330K(2)(3) | 1210(3) | 1250(3) | 1290(3) | 1330(3) |
| 33 | 20 | C05(4)(1)330M2X5C(2) | CK05BX330M | CKR05BX330M(2)(3) | 1211(3) | 1251(3) | 1291(3) | 1331(3) |
| 39 | 10 | C05(4)(1)390K2X5C(2) | CK05BX390K | CKR05BX390K(2)(3) | 1212(3) | 1252(3) | 1292(3) | 1332(3) |
| 47 | 10 | C05(4)(1)470K2X5C(2) | CK05BX470K | CKR05BX470K(2)(3) | 1213(3) | 1253(3) | 1293(3) | 1333(3) |
| 47 | 20 | C05(4)(1)470M2X5C(2) | CK05BX470M | CKR05BX470M(2)(3) | 1214(3) | 1254(3) | 1294(3) | 1334(3) |
| 56 | 10 | C05(4)(1)560K2X5C(2) | CK05BX560K | CKR05BX560K(2)(3) | 1215(3) | 1255(3) | 1295(3) | 1335(3) |
| 68 | 10 | C05(4)(1)680K2X5C(2) | CK05BX680K | CKR05BX680K(2)(3) | 1216(3) | 1256(3) | 1296(3) | 1336(3) |
| 68 | 20 | C05(4)(1)680M2X5C(2) | CK05BX680M | CKR05BX680M(2)(3) | 1217(3) | 1257(3) | 1297(3) | 1337(3) |
| 82 | 10 | C05(4)(1)820K2X5C(2) | CK05BX820K | CKR05BX820K(2)(3) | 1218(3) | 1258(3) | 1298(3) | 1338(3) |
| 100 | 10 | C05(4)(1)101K2X5C(2) | CK05BX101K | CKR05BX101K(2)(3) | 1219(3) | 1259(3) | 1299(3) | 1339(3) |
| 100 | 20 | C05(4)(1)101M2X5C(2) | CK05BX101M | CKR05BX101M(2)(3) | 1220(3) | 1260(3) | 1300(3) | 1340(3) |
| 120 | 10 | C05(4)(1)121K2X5C(2) | CK05BX121K | CKR05BX121K(2)(3) | 1221(3) | 1261(3) | 1301(3) | 1341(3) |
| 150 | 10 | C05(4)(1)151K2X5C(2) | CK05BX151K | CKR05BX151K(2)(3) | 1222(3) | 1262(3) | 1302(3) | 1342(3) |
| 150 | 20 | C05(4)(1)151M2X5C(2) | CK05BX151M | CKR05BX151M(2)(3) | 1223(3) | 1263(3) | 1303(3) | 1343(3) |
| 180 | 10 | C05(4)(1)181K2X5C(2) | CK05BX181K | CKR05BX181K(2)(3) | 1224(3) | 1264(3) | 1304(3) | 1344(3) |
| 220 | 10 | C05(4)(1)221K2X5C(2) | CK05BX221K | CKR05BX221K(2)(3) | 1225(3) | 1265(3) | 1305(3) | 1345(3) |
| 220 | 20 | C05(4)(1)221M2X5C(2) | CK05BX221M | CKR05BX221M(2)(3) | 1226(3) | 1266(3) | 1306(3) | 1346(3) |
| 270 | 10 | C05(4)(1)271K2X5C(2) | CK05BX271K | CKR05BX271K(2)(3) | 1227(3) | 1267(3) | 1307(3) | 1347(3) |
| 330 | 10 | C05(4)(1)331K2X5C(2) | CK05BX331K | CKR05BX331K(2)(3) | 1228(3) | 1268(3) | 1308(3) | 1348(3) |
| 330 | 20 | C05(4)(1)331M2X5C(2) | CK05BX331M | CKR05BX331M(2)(3) | 1229(3) | 1269(3) | 1309(3) | 1349(3) |
| 390 | 10 | C05(4)(1)391K2X5C(2) | CK05BX391K | CKR05BX391K(2)(3) | 1230(3) | 1270(3) | 1310(3) | 1350(3) |
| 470 | 10 | C05(4)(1)471K2X5C(2) | CK05BX471K | CKR05BX471K(2)(3) | 1231(3) | 1271(3) | 1311(3) | 1351(3) |
| 470 | 20 | C05(4)(1)471M2X5C(2) | CK05BX471M | CKR05BX471M(2)(3) | 1232(3) | 1272(3) | 1312(3) | 1352(3) |
| 560 | 10 | C05(4)(1)561K2X5C(2) | CK05BX561K | CKR05BX561K(2)(3) | 1233(3) | 1273(3) | 1313(3) | 1353(3) |
| 680 | 10 | C05(4)(1)681K2X5C(2) | CK05BX681K | CKR05BX681K(2)(3) | 1234(3) | 1274(3) | 1314(3) | 1354(3) |
| 680 | 20 | C05(4)(1)681M2X5C(2) | CK05BX681M | CKR05BX681M(2)(3) | 1235(3) | 1275(3) | 1315(3) | 1355(3) |
| 820 | 10 | C05(4)(1)821K2X5C(2) | CK05BX821K | CKR05BX821K(2)(3) | 1236(3) | 1276(3) | 1316(3) | 1356(3) |
| 1,000 | 10 | C05(4)(1)102K2X5C(2) | CK05BX102K | CKR05BX102K(2)(3) | 1237(3) | 1277(3) | 1317(3) | 1357(3) |
| 1,000 | 20 | C05(4)(1)102M2X5C(2) | CK05BX102M | CKR05BX102M(2)(3) | 1238(3) | 1278(3) | 1318(3) | 1358(3) |
| 100 VOLT — C052/C056 SIZE (MILITARY — CK05 or CKR05) | | | | | | | | |
| 1,200 | 10 | C05(4)(1)122K1X5C(2) | CK05BX122K | CKR05BX122K(2)(3) | 1239(3) | 1279(3) | 1319(3) | 1359(3) |
| 1,500 | 10 | C05(4)(1)152K1X5C(2) | CK05BX152K | CKR05BX152K(2)(3) | 1240(3) | 1280(3) | 1320(3) | 1360(3) |
| 1,500 | 20 | C05(4)(1)152M1X5C(2) | CK05BX152M | CKR05BX152M(2)(3) | 1441(3) | 1481(3) | 1521(3) | 1561(3) |
| 1,800 | 10 | C05(4)(1)182K1X5C(2) | CK05BX182K | CKR05BX182K(2)(3) | 1442(3) | 1482(3) | 1522(3) | 1562(3) |
| 2,200 | 10 | C05(4)(1)222K1X5C(2) | CK05BX222K | CKR05BX222K(2)(3) | 1443(3) | 1483(3) | 1523(3) | 1563(3) |
| 2,200 | 20 | C05(4)(1)222M1X5C(2) | CK05BX222M | CKR05BX222M(2)(3) | 1444(3) | 1484(3) | 1524(3) | 1564(3) |
| 2,700 | 10 | C05(4)(1)272K1X5C(2) | CK05BX272K | CKR05BX272K(2)(3) | 1445(3) | 1485(3) | 1525(3) | 1565(3) |
| 3,300 | 10 | C05(4)(1)332K1X5C(2) | CK05BX332K | CKR05BX332K(2)(3) | 1446(3) | 1486(3) | 1526(3) | 1566(3) |
| 3,300 | 20 | C05(4)(1)332M1X5C(2) | CK05BX332M | CKR05BX332M(2)(3) | 1447(3) | 1487(3) | 1527(3) | 1567(3) |
| 3,900 | 10 | C05(4)(1)392K1X5C(2) | CK05BX392K | CKR05BX392K(2)(3) | 1448(3) | 1488(3) | 1528(3) | 1568(3) |
| 4,700 | 10 | C05(4)(1)472K1X5C(2) | CK05BX472K | CKR05BX472K(2)(3) | 1449(3) | 1489(3) | 1529(3) | 1569(3) |
| 4,700 | 20 | C05(4)(1)472M1X5C(2) | CK05BX472M | CKR05BX472M(2)(3) | 1450(3) | 1490(3) | 1530(3) | 1570(3) |
| 5,600 | 10 | C05(4)(1)562K1X5C(2) | CK05BX562K | CKR05BX562K(2)(3) | 1451(3) | 1491(3) | 1531(3) | 1571(3) |
| 6,800 | 10 | C05(4)(1)682K1X5C(2) | CK05BX682K | CKR05BX682K(2)(3) | 1452(3) | 1492(3) | 1532(3) | 1572(3) |
| 6,800 | 20 | C05(4)(1)682M1X5C(2) | CK05BX682M | CKR05BX682M(2)(3) | 1453(3) | 1493(3) | 1533(3) | 1573(3) |
| 8,200 | 10 | C05(4)(1)822K1X5C(2) | CK05BX822K | CKR05BX822K(2)(3) | 1454(3) | 1494(3) | 1534(3) | 1574(3) |
| 10,000 | 10 | C05(4)(1)103K1X5C(2) | CK05BX103K | CKR05BX103K(2)(3) | 1455(3) | 1495(3) | 1535(3) | 1575(3) |
| 10,000 | 20 | C05(4)(1)103M1X5C(2) | CK05BX103M | CKR05BX103M(2)(3) | 1456(3) | 1496(3) | 1536(3) | 1576(3) |
| 50 VOLT — C052/C056 SIZE (MILITARY — CK05 or CKR05) | | | | | | | | |
| 12,000 | 10 | C05(4)(1)123K5X5C(2) | CK05BX123K | CKR05BX123K(2)(3) | 1457(3) | 1497(3) | 1537(3) | 1577(3) |
| 15,000 | 10 | C05(4)(1)153K5X5C(2) | CK05BX153K | CKR05BX153K(2)(3) | 1458(3) | 1498(3) | 1538(3) | 1578(3) |
| 15,000 | 20 | C05(4)(1)153M5X5C(2) | CK05BX153M | CKR05BX153M(2)(3) | 1459(3) | 1499(3) | 1539(3) | 1579(3) |
| 18,000 | 10 | C05(4)(1)183K5X5C(2) | CK05BX183K | CKR05BX183K(2)(3) | 1460(3) | 1500(3) | 1540(3) | 1580(3) |
| 22,000 | 10 | C05(4)(1)223K5X5C(2) | CK05BX223K | CKR05BX223K(2)(3) | 1461(3) | 1501(3) | 1541(3) | 1581(3) |
| 22,000 | 20 | C05(4)(1)223M5X5C(2) | CK05BX223M | CKR05BX223M(2)(3) | 1462(3) | 1502(3) | 1542(3) | 1582(3) |
| 27,000 | 10 | C05(4)(1)273K5X5C(2) | CK05BX273K | CKR05BX273K(2)(3) | 1463(3) | 1503(3) | 1543(3) | 1583(3) |
| 33,000 | 10 | C05(4)(1)333K5X5C(2) | CK05BX333K | CKR05BX333K(2)(3) | 1464(3) | 1504(3) | 1544(3) | 1584(3) |
| 33,000 | 20 | C05(4)(1)333M5X5C(2) | CK05BX333M | CKR05BX333M(2)(3) | 1465(3) | 1505(3) | 1545(3) | 1585(3) |
| 39,000 | 10 | C05(4)(1)393K5X5C(2) | CK05BX393K | CKR05BX393K(2)(3) | 1466(3) | 1506(3) | 1546(3) | 1586(3) |
| 47,000 | 10 | C05(4)(1)473K5X5C(2) | CK05BX473K | CKR05BX473K(2)(3) | 1467(3) | 1507(3) | 1547(3) | 1587(3) |
| 47,000 | 20 | C05(4)(1)473M5X5C(2) | CK05BX473M | CKR05BX473M(2)(3) | 1468(3) | 1508(3) | 1548(3) | 1588(3) |
| 56,000 | 10 | C05(4)(1)563K5X5C(2) | CK05BX563K | CKR05BX563K(2)(3) | 1469(3) | 1509(3) | 1549(3) | 1589(3) |
| 68,000 | 10 | C05(4)(1)683K5X5C(2) | CK05BX683K | CKR05BX683K(2)(3) | 1470(3) | 1510(3) | 1550(3) | 1590(3) |
| 68,000 | 20 | C05(4)(1)683M5X5C(2) | CK05BX683M | CKR05BX683M(2)(3) | 1471(3) | 1511(3) | 1551(3) | 1591(3) |
| 82,000 | 10 | C05(4)(1)823K5X5C(2) | CK05BX823K | CKR05BX823K(2)(3) | 1472(3) | 1512(3) | 1552(3) | 1592(3) |
| 100,000 | 10 | C05(4)(1)104K5X5C(2) | CK05BX104K | CKR05BX104K(2)(3) | 1473(3) | 1513(3) | 1553(3) | 1593(3) |
| 100,000 | 20 | C05(4)(1)104M5X5C(2) | CK05BX104M | CKR05BX104M(2)(3) | 1474(3) | 1514(3) | 1554(3) | 1594(3) |

(1) Insert proper letter for specification: K — MIL-C-11015; T — MIL-PRF-39014 (2) Failure Rate Designator: A — Not applicable (MIL-C-11015); M — 1%/1000 Hours, P — 1%/1000 Hours, R — .01%/1000 Hours, S — .001%/1000 Hours (MIL-PRF-39014)
 (3) Insert "V" for standard design (C056). Leave blank for the flat bottom design (C052).
 (4) Insert "2" for standard design (Style C052) } Note: Stand-offs are available only
 Insert "6" for stand-off design (Style C056) } with the CKR, not the CK.

RATINGS & PART NUMBER REFERENCE

| CAP. pF | TOL. % | KEMET PART NUMBER | MIL-C-11015/19 | MIL-PRF-39014/02 | MIL-PRF-39014/02 For Failure Rate Levels (2) | | | |
|---|-----------|----------------------|----------------|-------------------|--|---------|---------|---------|
| | | | | | M | P | R | S |
| 200 VOLT — C062/C066 SIZE (MILITARY — CK06 or CKR06) | | | | | | | | |
| 1,200 | 10 | C06(4)(1)122K2X5C(2) | CK06BX122K | CKR06BX122K(2)(3) | 1201(3) | 1241(3) | 1281(3) | 1321(3) |
| 1,500 | 10 | C06(4)(1)152K2X5C(2) | CK06BX152K | CKR06BX152K(2)(3) | 1202(3) | 1242(3) | 1282(3) | 1322(3) |
| 1,500 | 20 | C06(4)(1)152M2X5C(2) | CK06BX152M | CKR06BX152M(2)(3) | 1203(3) | 1243(3) | 1283(3) | 1323(3) |
| 1,800 | 10 | C06(4)(1)182K2X5C(2) | CK06BX182K | CKR06BX182K(2)(3) | 1204(3) | 1244(3) | 1284(3) | 1324(3) |
| 2,200 | 10 | C06(4)(1)222K2X5C(2) | CK06BX222K | CKR06BX222K(2)(3) | 1206(3) | 1246(3) | 1286(3) | 1326(3) |
| 2,200 | 20 | C06(4)(1)222M2X5C(2) | CK06BX222M | CKR06BX222M(2)(3) | 1207(3) | 1247(3) | 1287(3) | 1327(3) |
| 2,700 | 10 | C06(4)(1)272K2X5C(2) | CK06BX272K | CKR06BX272K(2)(3) | 1208(3) | 1248(3) | 1288(3) | 1328(3) |
| 3,300 | 10 | C06(4)(1)332K2X5C(2) | CK06BX332K | CKR06BX332K(2)(3) | 1209(3) | 1249(3) | 1289(3) | 1329(3) |
| 3,300 | 20 | C06(4)(1)332M2X5C(2) | CK06BX332M | CKR06BX332M(2)(3) | 1210(3) | 1250(3) | 1290(3) | 1330(3) |
| 3,900 | 10 | C06(4)(1)392K2X5C(2) | CK06BX392K | CKR06BX392K(2)(3) | 1211(3) | 1251(3) | 1291(3) | 1331(3) |
| 4,700 | 10 | C06(4)(1)472K2X5C(2) | CK06BX472K | CKR06BX472K(2)(3) | 1212(3) | 1252(3) | 1292(3) | 1332(3) |
| 4,700 | 20 | C06(4)(1)472M2X5C(2) | CK06BX472M | CKR06BX472M(2)(3) | 1213(3) | 1253(3) | 1293(3) | 1333(3) |
| 5,600 | 10 | C06(4)(1)562K2X5C(2) | CK06BX562K | CKR06BX562K(2)(3) | 1214(3) | 1254(3) | 1294(3) | 1334(3) |
| 6,800 | 10 | C06(4)(1)682K2X5C(2) | CK06BX682K | CKR06BX682K(2)(3) | 1215(3) | 1255(3) | 1295(3) | 1335(3) |
| 6,800 | 20 | C06(4)(1)682M2X5C(2) | CK06BX682M | CKR06BX682M(2)(3) | 1216(3) | 1256(3) | 1296(3) | 1336(3) |
| 8,200 | 10 | C06(4)(1)822K2X5C(2) | CK06BX822K | CKR06BX822K(2)(3) | 1217(3) | 1257(3) | 1297(3) | 1337(3) |
| 10,000 | 10 | C06(4)(1)103K2X5C(2) | CK06BX103K | CKR06BX103K(2)(3) | 1218(3) | 1258(3) | 1298(3) | 1338(3) |
| 10,000 | 20 | C06(4)(1)103M2X5C(2) | CK06BX103M | CKR06BX103M(2)(3) | 1219(3) | 1259(3) | 1299(3) | 1339(3) |
| 100 VOLT — C062/C066 SIZE (MILITARY — CK06 or CKR06) | | | | | | | | |
| 12,000 | 10 | C06(4)(1)123K1X5C(2) | CK06BX123K | CKR06BX123K(2)(3) | 1231(3) | 1271(3) | 1311(3) | 1351(3) |
| 15,000 | 10 | C06(4)(1)153K1X5C(2) | CK06BX153K | CKR06BX153K(2)(3) | 1220(3) | 1260(3) | 1300(3) | 1340(3) |
| 15,000 | 20 | C062K153M1X5CA | CK06BX153M | | | | | |
| 18,000 | 10 | C06(4)(1)183K1X5C(2) | CK06BX183K | CKR06BX183K(2)(3) | 1221(3) | 1261(3) | 1301(3) | 1341(3) |
| 22,000 | 10 | C06(4)(1)223K1X5C(2) | CK06BX223K | CKR06BX223K(2)(3) | 1222(3) | 1262(3) | 1302(3) | 1342(3) |
| 22,000 | 20 | C062K223M1X5CA | CK06BX223M | | | | | |
| 27,000 | 10 | C06(4)(1)273K1X5C(2) | CK06BX273K | CKR06BX273K(2)(3) | 1232(3) | 1272(3) | 1312(3) | 1352(3) |
| 33,000 | 10 | C06(4)(1)333K1X5C(2) | CK06BX333K | CKR06BX333K(2)(3) | 1223(3) | 1263(3) | 1303(3) | 1343(3) |
| 33,000 | 20 | C062K333M1X5CA | CK06BX333M | | | | | |
| 39,000 | 10 | C06(4)(1)393K1X5C(2) | CK06BX393K | CKR06BX393K(2)(3) | 1224(3) | 1264(3) | 1304(3) | 1344(3) |
| 47,000 | 10 | C06(4)(1)473K1X5C(2) | CK06BX473K | CKR06BX473K(2)(3) | 1225(3) | 1265(3) | 1305(3) | 1345(3) |
| 47,000 | 20 | C062K473M1X5CA | CK06BX473M | | | | | |
| 56,000 | 10 | C06(4)(1)563K1X5C(2) | CK06BX563K | CKR06BX563K(2)(3) | 1226(3) | 1266(3) | 1306(3) | 1346(3) |
| 68,000 | 10 | C06(4)(1)683K1X5C(2) | CK06BX683K | CKR06BX683K(2)(3) | 1227(3) | 1267(3) | 1307(3) | 1347(3) |
| 68,000 | 20 | C062K683M1X5CA | CK06BX683M | | | | | |
| 82,000 | 10 | C06(4)(1)823K1X5C(2) | CK06BX823K | CKR06BX823K(2)(3) | 1229(3) | 1269(3) | 1309(3) | 1349(3) |
| 100,000 | 10 | C06(4)(1)104K1X5C(2) | CK06BX104K | CKR06BX104K(2)(3) | 1230(3) | 1270(3) | 1310(3) | 1350(3) |
| 100,000 | 20 | C062K104M1X5CA | CK06BX104M | | | | | |
| 50 VOLT — C062/C066 SIZE (MILITARY — CK06 or CKR06) | | | | | | | | |
| 120,000 | 10 | C06(4)(1)124K5X5C(2) | CK06BX124K | CKR06BX124K(2)(3) | 1233(3) | 1273(3) | 1313(3) | 1353(3) |
| 150,000 | 10 | C06(4)(1)154K5X5C(2) | CK06BX154K | CKR06BX154K(2)(3) | 1234(3) | 1274(3) | 1314(3) | 1354(3) |
| 150,000 | 20 | C062K154M5X5CA | CK06BX154M | | | | | |
| 180,000 | 10 | C06(4)(1)184K5X5C(2) | CK06BX184K | CKR06BX184K(2)(3) | 1235(3) | 1275(3) | 1315(3) | 1355(3) |
| 220,000 | 10 | C06(4)(1)224K5X5C(2) | CK06BX224K | CKR06BX224K(2)(3) | 1236(3) | 1276(3) | 1316(3) | 1356(3) |
| 220,000 | 20 | C062K224M5X5CA | CK06BX224M | | | | | |
| 270,000 | 10 | C06(4)(1)274K5X5C(2) | CK06BX274K | CKR06BX274K(2)(3) | 1237(3) | 1277(3) | 1317(3) | 1357(3) |
| 330,000 | 10 | C06(4)(1)334K5X5C(2) | CK06BX334K | CKR06BX334K(2)(3) | 1238(3) | 1278(3) | 1318(3) | 1358(3) |
| 330,000 | 20 | C062K334M5X5CA | CK06BX334M | | | | | |
| 390,000 | 10 | C06(4)(1)394K5X5C(2) | CK06BX394K | CKR06BX394K(2)(3) | 1239(3) | 1279(3) | 1319(3) | 1359(3) |
| 470,000 | 10 | C06(4)(1)474K5X5C(2) | CK06BX474K | CKR06BX474K(2)(3) | 1240(3) | 1280(3) | 1320(3) | 1360(3) |
| 470,000 | 20 | C062K474M5X5CA | CK06BX474M | | | | | |
| 560,000 | 10 | C06(4)(1)564K5X5C(2) | CK06BX564K | CKR06BX564K(2)(3) | 1404(3) | 1408(3) | 1412(3) | 1416(3) |
| 680,000 | 10 | C06(4)(1)684K5X5C(2) | CK06BX684K | CKR06BX684K(2)(3) | 1405(3) | 1409(3) | 1413(3) | 1417(3) |
| 680,000 | 20 | C062K684M5X5CA | CK06BX684M | | | | | |
| 820,000 | 10 | C06(4)(1)824K5X5C(2) | CK06BX824K | CKR06BX824K(2)(3) | 1406(3) | 1410(3) | 1414(3) | 1418(3) |
| 1,000,000 | 10 | C06(4)(1)105K5X5C(2) | CK06BX105K | CKR06BX105K(2)(3) | 1407(3) | 1411(3) | 1415(3) | 1419(3) |
| 1,000,000 | 20 | C062K105M5X5CA | CK06BX105M | | | | | |

(1) Insert proper letter for specification: K — MIL-C-11015; T — MIL-PRF-39014.
 (2) Failure Rate Designator: A — Not applicable (MIL-C-11015); M — 1%/1000 Hours, P — .1%/1000 Hours, R — .01%/1000 Hours, S — .001%/1000 Hours (MIL-PRF-39014)
 (3) Add "V" for stand-off design (C066). Leave blank for the flat bottom design (C062).
 (4) Insert "2" for standard design (Style C062). Insert "6" for stand-off design (Style C066). Note: Stand-offs are available only with the CKR, not the CK.

**MIL-C-11015
MIL-PRF-39014**

**Ceramic Axial
Lead Tape and Reel Packaging**

KEMET offers standard reeling of Molded and Conformally Coated Axial Leaded Ceramic Capacitors for automatic insertion or lead forming machines per EIA specification RS-296.

Paper (50 lb.) test minimum is inserted between the layers of capacitors wound on reels for component pitch $\leq 0.400"$. Capacitor lead length may extend only a maximum of $.0625"$ (1.59mm) beyond the tapes' edges. Capacitors are centered in a row between the two tapes and will deviate only ± 0.031 (0.79mm) from the row center. A minimum of 36" (91.5 cm) leader tape is provided at each end of the reel capacitors. Universal splicing clips are used to connect the tape. Standard reel quantities are shown on page 34.

Figure 1

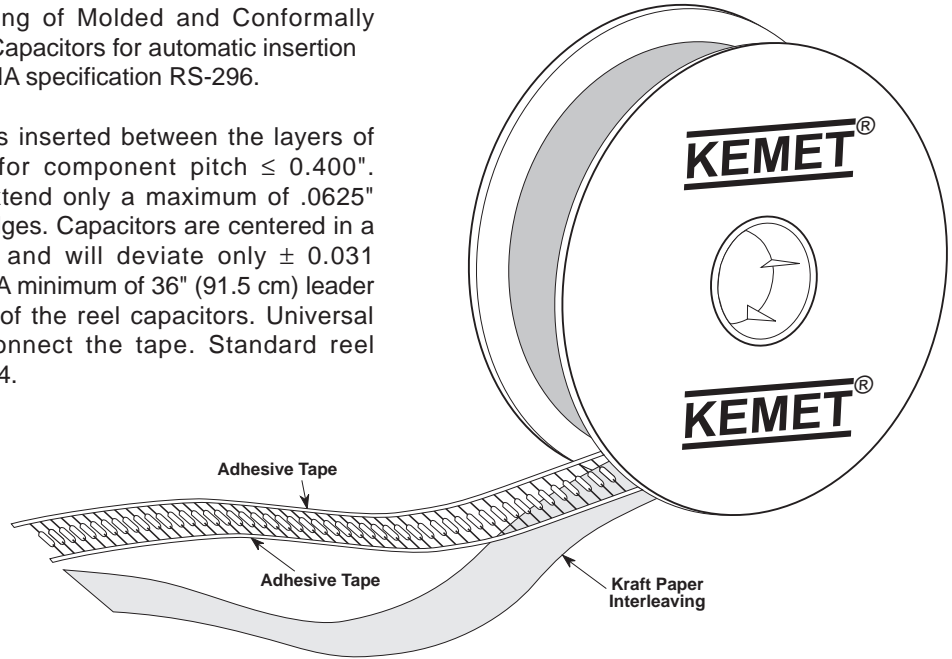

Figure 2

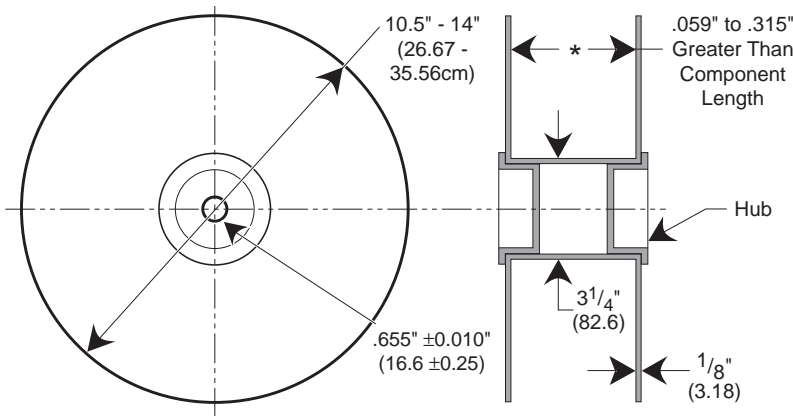

Figure 3

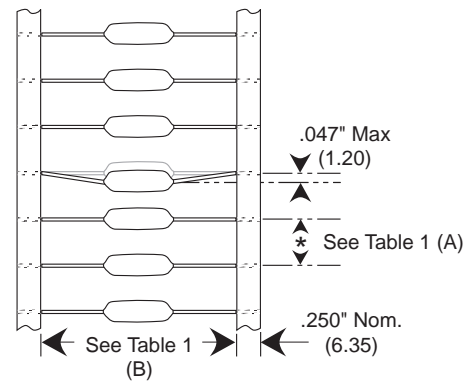

Table 1 Dimensions in Inches & (Millimeters)

| Component Body Diameter | Component Pitch "A" | Inside Tape Spacing "B" $\pm 1.5\text{mm}$ (0.059") | |
|--|-------------------------------------|---|---------------|
| | | I | III* |
| 0" (0mm) to 0.197" (5mm) 0.197" (5.01mm) to 0.394" (10mm) | 0.197" or (5mm) 0.394" or (10mm) | 2.062" (52.4mm) | 2.874" (73mm) |

* Not Available for Conformally Coated Parts.

Ceramic Radial Lead Tape and Reel Packaging

KEMET offers standard reeling of Molded and Conformally Coated Radial Leaded Ceramic Capacitors for automatic insertion per EIA specification RS-468. Parts are taped to a tagboard carrier strip, and wound on a reel as shown in Figure 1. Kraft paper interleaving is inserted between the layers of capacitors on the reel. Ammopack is also available, with the same lead tape configuration and package quantities.

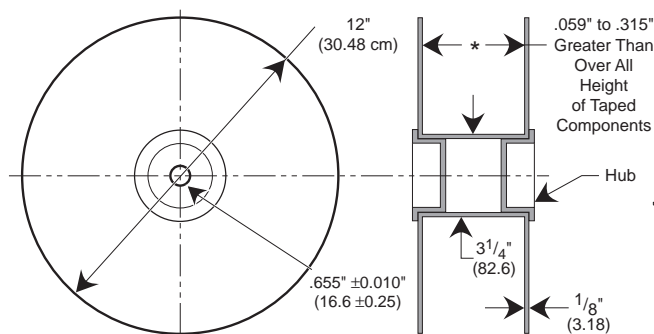

Figure 3: Standard Reel

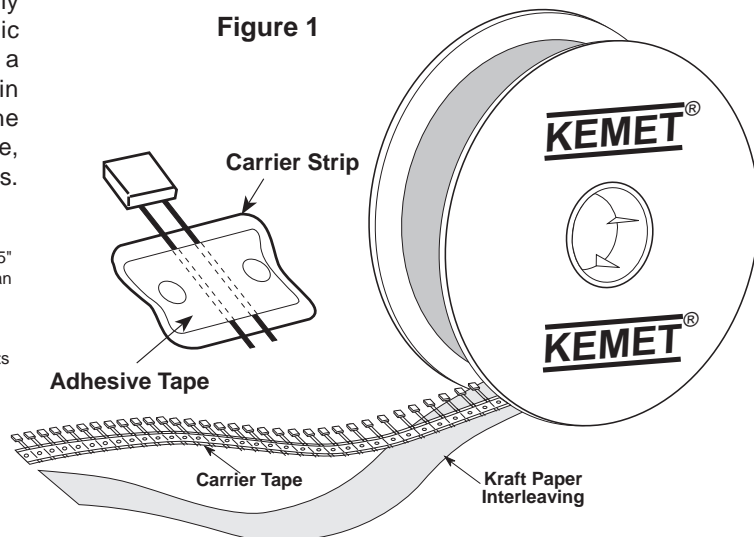

Figure 1

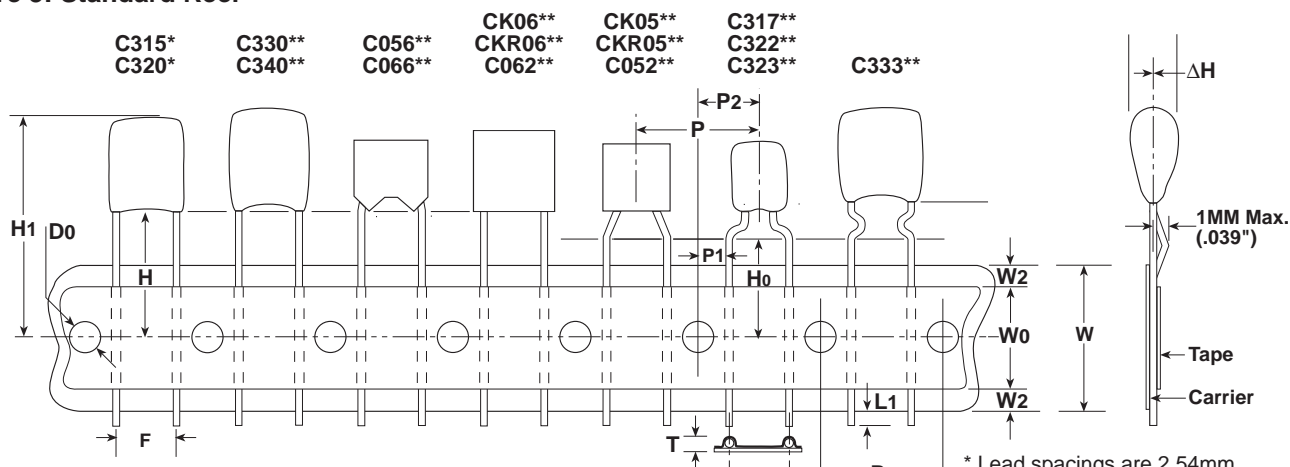

Figure 2: Lead Tape Configuration (See Table Below)

* Lead spacings are 2.54mm (.10") center-to-center.
** Lead spacings are 5.08mm (.20") center-to-center.

Ceramic Radial Tape and Reel Dimensions in Millimeters & (Inches)

| Dimension | Symbol | Nominal mm (inch) | | Tolerance mm (inch) | | Dimension | Symbol | Nominal mm (inch) | | Tolerance mm (inch) | |
|--|--------|-------------------|-------------------|-------------------------|--|--|--------|-------------------|-------------------------|--------------------------|-------------|
| Sprocket Hole Diameter | Do | 4.0 (.157) | | ± 0.2 (.008) | | Height to Seating Plane (formed leads) (2) | Ho | C7301 C7303 | 16.0 (.630) 18.0 (.709) | | C7301 C7303 |
| Sprocket Hole Pitch | P0 | 12.7 (.500) | | ± 0.3 (.012) | | Component Alignment | Δh | 4.0 (.157) | | ± 0.5 (.020) Minimum | |
| Component Pitch | P | 12.7 (.500) | | ± 0.3 (.012) | | Lead Protrusion | L1 | 1.0 (.039) | | Maximum | |
| Lead Spacing (1) | F | 5.08 (.20) | 2.54 (.10) | +0.6 -0.2 (+.024 -.008) | | Composite Tape Thickness | t | 0.7 (.051) | | ± 0.2 (.008) | |
| Sprocket Hole Center to Lead Center (1) | P1 | 3.81 (.150) | 5.08 (.200) | ± 0.7 (.028) | | Overall Tape and Lead Thickness | T | 1.5 (.059) | | Maximum | |
| Sprocket Hole Center to Component Center | P2 | 6.35 (.250) | | ± 1.3 (.051) | | Carrier Tape Width | W | 18.0 (.709) | | +1.0 - 0.5 (+.039 -.020) | |
| Height to Seating Plane (straight leads) (2) | H | C7301 16.0 (.630) | C7303 18.0 (.709) | ± 0.5 (.020) Minimum | | Hold-Down Tape Width | W0 | 5.0 (.197) | | Minimum | |
| Component Height Above Tape Center | H1 | 32.2 (1.27) | | Maximum | | Hold-Down Tape Location | W2 | 3.0 (.118) | | Maximum | |

(1) Measured at the egress from the carrier tape, on the component side.
(2) Determined by a 4 digit suffix placed at the end of the part number, as follows:
7301 = Recommended for parts with formed leads. Example: C322C104K5R5CA7301
7303 = Recommended for parts with straight leads. Example: C320C104K5R5CA7303

| CERAMIC PACKAGING | | | | | |
|--------------------------|-----------------------|-------------------------------|-----------------------------------|-------------------------------|------------------|
| KEMET Number | Military Style | Military Specification | Standard (1) Bulk Quantity | Standard Reel Quantity | Reel Size |
| C114C-K-G | CK12, CC75 | MIL-C-11015/ | 200/Box | 5000 | 12" |
| C124C-K-G | CK13, CC76 | MIL-PRF-20 | 200/Box | 5000 | 12" |
| C192C-K-G | CK14, CC77 | | 100/Box | 3000 | 12" |
| C202C-K | CK15 | | 25/Box | 500 | 12" |
| C222C-K | CK16 | | 10/Tray | 300 | 12" |
| C052C-K-G | CK05, CC05 | | 100/Bag | 2000 | 12" |
| C062C-K-G | CK06, CC06 | | 100/Bag | 1500 | 12" |
| C114G | CCR75 | MIL-PRF-20 | 200/Box | 5000 | 12" |
| C124G | CCR76 | | 200/Box | 5000 | 12" |
| C192G | CCR77 | | 100/Box | 3000 | 12" |
| C202G | CC78-CCR78 | | 25/Box | 500 | 12" |
| C222G | CC79-CCR79 | | 10/Tray | 300 | 12" |
| C052/56G | CCR05 | | 100/Bag | 1700 | 12" |
| C062/66G | CCR06 | | 100/Bag | 1500 | 12" |
| C512G | CC07-CCR07 | | Footnote (2) | N/A | N/A |
| C522G | CC08-CCR08 | | Footnote (2) | N/A | N/A |
| C114T | CKR11 | MIL-PRF-39014 | 200/Box | 5000 | 12" |
| C124T | CKR12 | | 200/Box | 5000 | 12" |
| C192T | CKR14 | | 100/Box | 3000 | 12" |
| C202T | CKR15 | | 25/Box | 500 | 12" |
| C222T | CKR16 | | 10/Tray | 300 | 12" |
| C052/56T | CKR05 | | 100/Bag | 1700 | 12" |
| C062/66T | CKR06 | | 100/Bag | 1500 | 12" |
| C31X | | | 500/Bag | 2500 | 12" |
| C32X | | | 500/Bag | 2500 | 12" |
| C33X | | | 250/Bag | 1500 | 12" |
| C340 | | | 100/Bag | 1000 | 12" |
| C350 | | | 50/Bag | N/A | N/A |
| C410 | | | 300/Box | 5000 | 12" |
| C412 | | | 200/Box | 5000 | 12" |
| C420 | | | 300/Box | 5000 | 12" |
| C430 | | | 200/Box | 2500 | 12" |
| C440 | | | 200/Box | 2500 | 12" |
| C512 | N/A | N/A | Footnote (2) | N/A | N/A |
| C522 | N/A | N/A | Footnote (2) | N/A | N/A |

NOTE: (1) Standard packaging refers to number of pieces per bag, box, tray or vial.
(2) Quantity varies. For further details, please consult the factory.

ELECTRICAL CHARACTERISTICS

The fundamental electrical properties of multilayer ceramic capacitors are as follows:

Polarity: Multilayer ceramic capacitors are not polar, and may be used with DC voltage applied in either direction.

Rated Voltage: This term refers to the maximum continuous DC working voltage permissible across the entire operating temperature range. Multilayer ceramic capacitors are not extremely sensitive to voltage, and brief applications of voltage above rated will not result in immediate failure. However, reliability will be reduced by exposure to sustained voltages above rated.

Capacitance: The standard unit of capacitance is the farad. For practical capacitors, it is usually expressed in microfarads (10⁻⁶ farad), nanofarads (10⁻⁹ farad), or picofarads (10⁻¹² farad). Standard measurement conditions are as follows:

- Class I (up to 1,000 pF): 1MHz and 1.2 VRMS maximum.
- Class I (over 1,000 pF): 1kHz and 1.2 VRMS maximum.
- Class II: 1 kHz and 1.0 ± 0.2 VRMS.
- Class III: 1 kHz and 0.5 ± 0.1 VRMS.

Like all other practical capacitors, multilayer ceramic capacitors also have resistance and inductance. A simplified schematic for the equivalent circuit is shown in Figure 1. Other significant electrical characteristics resulting from these additional properties are as follows:

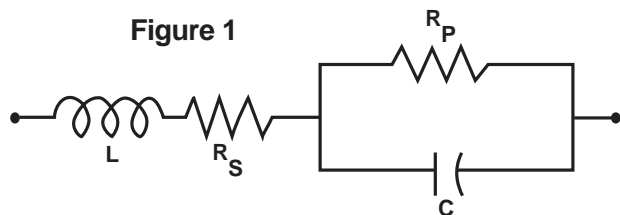

- C = Capacitance
- L = Inductance
- RS = Equivalent Series Resistance (ESR)
- RP = Insulation Resistance (IR)

Impedance: Since the parallel resistance (Rp) is normally very high, the total impedance of the capacitor is:

$$Z = \sqrt{R_S^2 + (X_C - X_L)^2}$$

- Where Z = Total Impedance
- RS = Equivalent Series Resistance
- XC = Capacitive Reactance = 1/(2 πfC)
- XL = Inductive Reactance = 2 πfL

The variation of a capacitor's impedance with frequency determines its effectiveness in many applications.

Dissipation Factor: Dissipation Factor (DF) is a measure of the losses in a capacitor under AC application. It is the ratio of the equivalent series resistance to the capacitive reactance, and is usually expressed in percent. It is usually measured simultaneously with capacitance, and under the same conditions. The vector diagram in Figure 2 illustrates the relationship between DF, ESR, and impedance. The reciprocal of the dissipation factor is called the "Q", or quality factor. For convenience, the "Q" factor is often used for very low values of dissipation factor. DF is sometimes called the "loss tangent" or "tangent δ", as derived from this diagram.

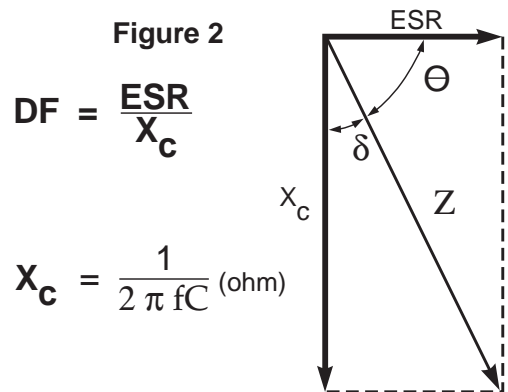

$$DF = \frac{ESR}{X_C}$$

$$X_C = \frac{1}{2 \pi fC} \text{ (ohm)}$$

Insulation Resistance: Insulation Resistance (IR) is the DC resistance measured across the terminals of a capacitor, represented by the parallel resistance (Rp) shown in Figure 1. For a given dielectric type, electrode area increases with capacitance, resulting in a decrease in the insulation resistance. Consequently, insulation resistance is usually specified as the "RC" (IR x C) product, in terms of ohm-farads or megohm-microfarads. The insulation resistance for a specific capacitance value is determined by dividing this product by the capacitance. However, as the nominal capacitance values become small, the insulation resistance calculated from the RC product reaches values which are impractical. Consequently, IR specifications usually include both a minimum RC product and a maximum limit on the IR calculated from that value. For example, a typical IR specification might read "1,000 megohm-microfarads or 100 gigohms, whichever is less."

Insulation Resistance is the measure of a capacitor to resist the flow of DC leakage current. It is sometimes referred to as "leakage resistance." The DC leakage current may be calculated by dividing the applied voltage by the insulation resistance (Ohm's Law).

Dielectric Withstanding Voltage: Dielectric withstanding voltage (DWV) is the peak voltage which a capacitor is designed to withstand for short periods of time without damage. All KEMET multilayer ceramic capacitors will withstand a test voltage of 2.5 x the rated voltage for 60 seconds.

KEMET specification limits for these characteristics at standard measurement conditions are shown in Table 1 on page 4. Variations in these properties caused by changing conditions of temperature, voltage, frequency, and time are covered in the following sections.

TABLE 1
EIA TEMPERATURE CHARACTERISTIC CODES
FOR CLASS I DIELECTRICS

| Significant Figure of Temperature Coefficient | | Multiplier Applied to Temperature Coefficient | | Tolerance of Temperature Coefficient * | |
|---|---------------|---|---------------|--|---------------|
| PPM per Degree C | Letter Symbol | Multi-plier | Number Symbol | PPM per Degree C | Letter Symbol |
| 0.0 | C | -1 | 0 | ±30 | G |
| 0.3 | B | -10 | 1 | ±60 | H |
| 0.9 | A | -100 | 2 | ±120 | J |
| 1.0 | M | -1000 | 3 | ±250 | K |
| 1.5 | P | -100000 | 4 | ±500 | L |
| 2.2 | R | +1 | 5 | ±1000 | M |
| 3.3 | S | +10 | 6 | ±2500 | N |
| 4.7 | T | +100 | 7 | | |
| 7.5 | U | +1000 | 8 | | |
| | | +10000 | 9 | | |

* These symmetrical tolerances apply to a two-point measurement of temperature coefficient: one at 25°C and one at 85°C. Some deviation is permitted at lower temperatures. For example, the PPM tolerance for C0G at -55 is +30 / -72 PPM.

TABLE 2
EIA TEMPERATURE CHARACTERISTIC CODES
FOR CLASS II & III DIELECTRICS

| Low Temperature Rating | | High Temperature Rating | | Maximum Capacitance Shift | |
|------------------------|---------------|-------------------------|---------------|---------------------------|---------------|
| Degree Celcius | Letter Symbol | Degree Celcius | Number Symbol | Percent | Letter Symbol |
| +10C | Z | +45C | 2 | ±1.0% | A |
| -30C | Y | +65C | 4 | ±1.5% | B |
| -55C | X | +85C | 5 | ±2.2% | C |
| | | +105C | 6 | ±3.3% | D |
| | | +125C | 7 | ±4.7% | E |
| | | +150C | 8 | ±7.5% | F |
| | | +200C | 9 | ±10.0% | P |
| | | | | ±15.0% | R |
| | | | | ±22.0% | S |
| | | | | ±22/-33% | T |
| | | | | ±22/-56% | U |
| | | | | ±22/-82% | V |

EFFECT OF TEMPERATURE

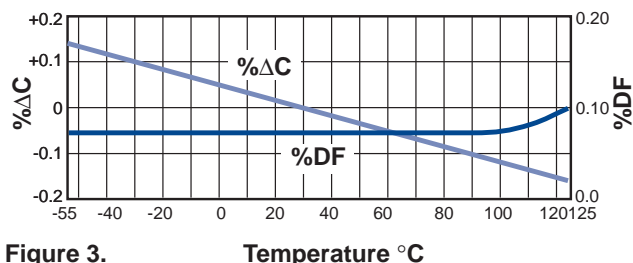

Figure 3. Capacitance & DF vs Temperature - C0G

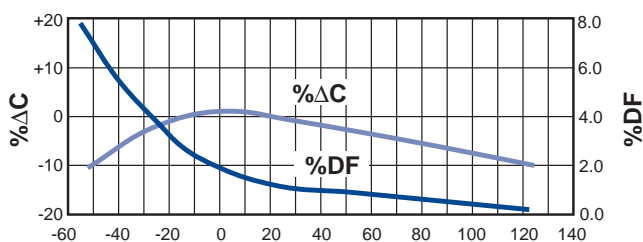

Figure 4. Capacitance & DF vs Temperature - X7R

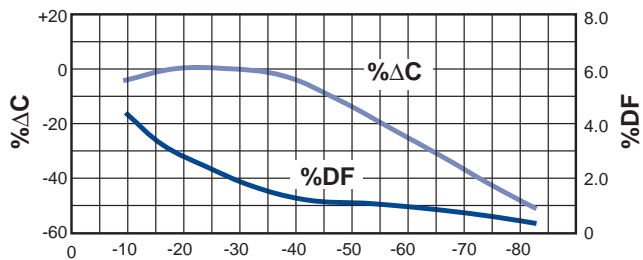

Figure 5. Capacitance & DF vs Temperature - Z5U

EFFECT OF APPLIED VOLTAGE

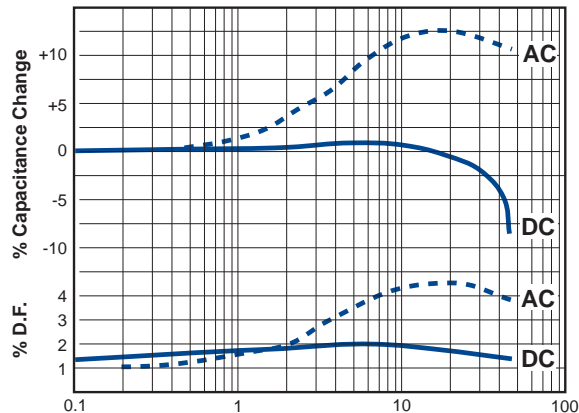

Figure 6. AC or DC Volts Applied
Typical Effects of 1000 Hz AC and DC Voltage Level on
Capacitance and Dissipation Factor - X7R

Note: C0G Dielectric capacitance and dissipation factor are stable with voltage.

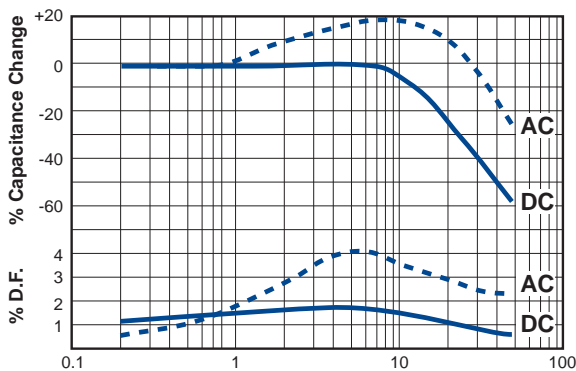

Figure 7. AC or DC Volts Applied
Typical Effects of 1000 Hz AC and DC Voltage Level on
Capacitance and Dissipation Factor - Z5U

Note: C0G Dielectric capacitance and dissipation factor are stable with voltage.

Effect of Temperature: Both capacitance and dissipation factor are affected by variations in temperature. The maximum capacitance change with temperature is defined by the temperature characteristic. However, this only defines a “box” bounded by the upper and lower operating temperatures and the minimum and maximum capacitance values. Within this “box”, the variation with temperature depends upon the specific dielectric formulation. Typical curves for KEMET capacitors are shown in Figures 3, 4, and 5. These figures also include the typical change in dissipation factor for KEMET capacitors.

Insulation resistance decreases with temperature. Typically, the insulation resistance at maximum rated temperature is 10% of the 25°C value.

Effect of Voltage: Class I ceramic capacitors are not affected by variations in applied AC or DC voltages. For Class II and III ceramic capacitors, variations in voltage affect only

the capacitance and dissipation factor. The application of DC voltage higher than 5 vdc reduces both the capacitance and dissipation factor. The application of AC voltages up to 10-20 Vac tends to increase both capacitance and dissipation factor. At higher AC voltages, both capacitance and dissipation factor begin to decrease.

Typical curves showing the effect of applied AC and DC voltage are shown in Figure 6 for KEMET X7R capacitors and Figure 7 for KEMET Z5U capacitors.

Effect of Frequency: Frequency affects both capacitance and dissipation factor. Typical curves for KEMET multilayer ceramic capacitors are shown in Figures 8 and 9.

The variation of impedance with frequency is an important consideration in the application of multilayer ceramic capacitors. Total impedance of the capacitor is the vector of the capacitive reactance, the inductive reactance, and the ESR, as illustrated in Figure 2. As frequency increases, the capacitive reactance decreases. However, the series inductance (L) shown in Figure 1 produces inductive reactance, which increases with frequency. At some frequency, the impedance ceases to be capacitive and becomes inductive. This point, at the bottom of the V-shaped impedance versus frequency curves, is the self-resonant frequency. At the self-resonant frequency, the reactance is zero, and the impedance consists of the ESR only.

Typical impedance versus frequency curves for KEMET multilayer ceramic capacitors are shown in Figures 10, 11, and 12. These curves apply to KEMET capacitors in chip form, without leads. Lead configuration and lead length have a significant impact on the series inductance. The lead inductance is approximately 10nH/inch, which is large compared to the inductance of the chip. The effect of this additional inductance is a decrease in the self-resonant frequency, and an increase in impedance in the inductive region above the self-resonant frequency.

Effect of Time: The capacitance of Class II and III dielectrics change with time as well as with temperature, voltage and frequency. This change with time is known as “aging.” It is caused by gradual realignment of the crystalline structure of the ceramic dielectric material as it is cooled below its Curie temperature, which produces a loss of capacitance with time. The aging process is predictable and follows a logarithmic decay. Typical aging rates for C0G, X7R, and Z5U dielectrics are as follows:

| | |
|-----|-------------------------|
| C0G | None |
| X7R | 1.0% per decade of time |
| Z5U | 5.0% per decade of time |

Typical aging curves for X7R and Z5U dielectrics are shown in Figure 13.

The aging process is reversible. If the capacitor is heated to a temperature above its Curie point for some period of time, de-aging will occur and the capacitor will regain the capacitance lost during the aging process. The amount of de-aging depends on both the elevated temperature and the length of time at that temperature. Exposure to 150°C for one-half hour or 125°C for two hours is usually sufficient to return the capacitor to its initial value.

Because the capacitance changes rapidly immediately after de-aging, capacitance measurements are usually delayed for at least 10 hours after the de-aging process, which is often referred to as the “last heat.” In addition, manufacturers utilize

the aging rates to set factory test limits which will bring the capacitance within the specified tolerance at some future time, to allow for customer receipt and use. Typically, the test limits are adjusted so that the capacitance will be within the specified tolerance after either 1,000 hours or 100 days, depending on the manufacturer and the product type.

POWER DISSIPATION

Power dissipation has been empirically determined for two representative KEMET series: C052 and C062. Power dissipation capability for various mounting configurations is shown in Table 3. This table was extracted from Engineering Bulletin F-2013, which provides a more detailed treatment of this subject.

Note that no significant difference was detected between the two sizes in spite of a 2 to 1 surface area ratio. Due to the materials used in the construction of multilayer ceramic capacitors, the power dissipation capability does not depend greatly on the surface area of the capacitor body, but rather on how well heat is conducted out of the capacitor lead wires. Consequently, this power dissipation capability is applicable to other leaded multilayer styles and sizes.

**TABLE 3
POWER DISSIPATION CAPABILITY
(Rise in Celsius degrees per Watt)**

| Mounting Configuration | Power Dissipation of C052 & C062 |
|--|---------------------------------------|
| 1.00" leadwires attached to binding post of GR-1615 bridge (excellent heat sink) | 90 Celsius degrees rise per Watt ±10% |
| 0.25" leadwires attached to binding post of GR-1615 bridge | 55 Celsius degrees rise per Watt ±10% |
| Capacitor mounted flush to 0.062" glass-epoxy circuit board with small copper traces | 77 Celsius degrees rise per Watt ±10% |
| Capacitor mounted flush to 0.062" glass-epoxy circuit board with four square inches of copper land area as a heat sink | 53 Celsius degrees rise per Watt ±10% |

As shown in Table 3, the power dissipation capability of the capacitor is very sensitive to the details of its use environment. The temperature rise due to power dissipation should not exceed 20°C. Using that constraint, the maximum permissible power dissipation may be calculated from the data provided in Table 3.

It is often convenient to translate power dissipation capability into a permissible AC voltage rating. Assuming a sinusoidal wave form, the RMS "ripple voltage" may be calculated from the following formula:

$$E = Z \sqrt{\frac{P}{R}}$$

Where E = RMS Ripple Voltage (volts)

P = Power Dissipation (watts)

Z = Impedance

R = ESR

The data necessary to make this calculation is included in Engineering Bulletin F-2013. However, the following criteria must be observed:

1. The temperature rise due to power dissipation should be limited to 20°C.
2. The peak AC voltage plus the DC voltage must not exceed the maximum working voltage of the capacitor.

Provided that these criteria are met, multilayer ceramic capacitors may be operated with AC voltage applied without need for DC bias.

RELIABILITY

A well constructed multilayer ceramic capacitor is extremely reliable and, for all practical purposes, has an infinite life span when used within the maximum voltage and temperature ratings. Capacitor failure may be induced by sustained operation at voltages that exceed the rated DC voltage, voltage spikes or transients that exceed the dielectric withstanding voltage, sustained operation at temperatures above the maximum rated temperature, or the excessive temperature rise due to power dissipation.

Failure rate is usually expressed in terms of percent per 1,000 hours or in FITS (failure per billion hours). Some KEMET series are qualified under U.S. military established reliability specifications MIL-PRF-20, MIL-PRF-123, MIL-PRF-39014, and MIL-PRF-55681. Failure rates as low as 0.001% per 1,000 hours are available for all capacitance / voltage ratings covered by these specifications. These specifications and accompanying Qualified Products List should be consulted for details.

For series not covered by these military specifications, an internal testing program is maintained by KEMET Quality Assurance. Samples from each week's production are subjected to a 2,000 hour accelerated life test at 2 x rated voltage and maximum rated temperature. Based on the results of these tests, the average failure rate for all non-military series covered by this test program is currently 0.06% per 1,000 hours at maximum rated conditions. The failure rate would be much lower at typical use conditions. For example, using MIL-HDBK-217D this failure rate translates to 0.9 FITS at 50% rated voltage and 50°C.

Current failure rate details for specific KEMET multilayer ceramic capacitor series are available on request.

MISAPPLICATION

Ceramic capacitors, like any other capacitors, may fail if they are misapplied. Typical misapplications include exposure to excessive voltage, current or temperature. If the dielectric layer of the capacitor is damaged by misapplication the electrical energy of the circuit can be released as heat, which may damage the circuit board and other components as well.

If potential for misapplication exists, it is recommended that precautions be taken to protect personnel and equipment during initial application of voltage. Commonly used precautions include shielding of personnel and sensing for excessive power drain during board testing.

EFFECT OF FREQUENCY

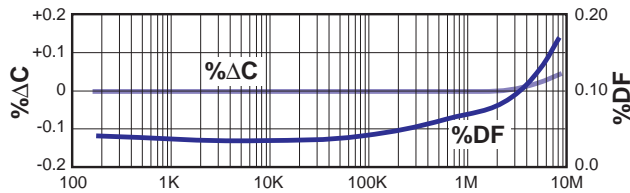

Figure 8. Frequency - Hertz
Capacitance & DF vs Frequency - C0G

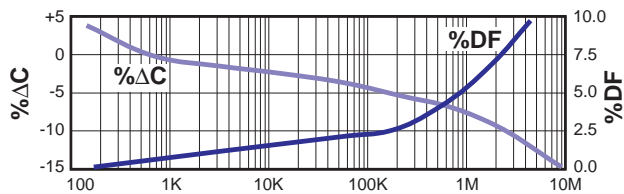

Figure 9. Frequency - Hertz
Capacitance & DF vs Frequency - X7R & Z5U

EFFECT OF TIME

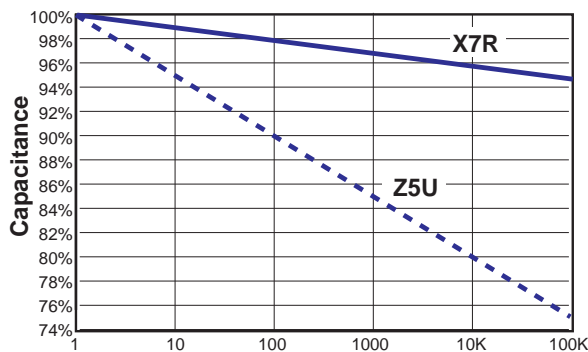

Figure 13. Typical Aging Rates for X7R & Z5U

IMPEDANCE VS FREQUENCY

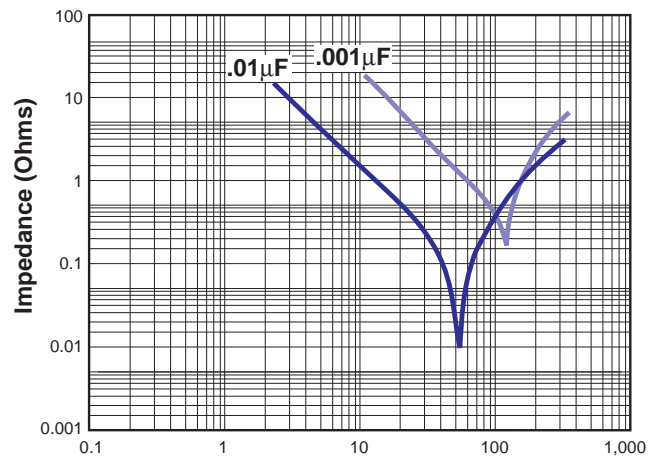

Figure 10. Frequency - MHz
Impedance vs Frequency for C0G Dielectric

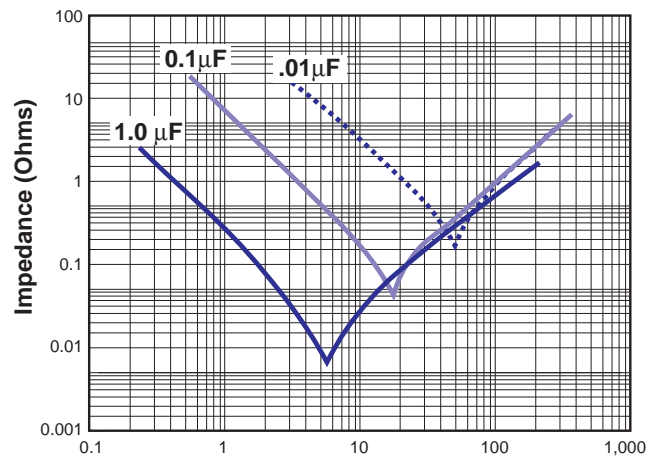

Figure 11. Frequency - MHz
Impedance vs Frequency for X7R Dielectric

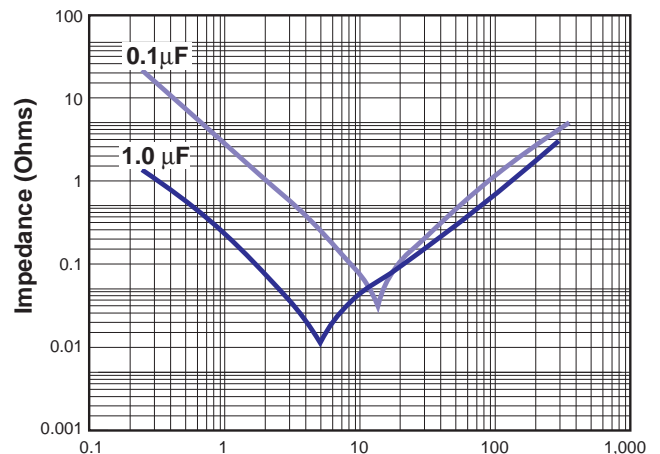

Figure 12. Frequency - MHz
Impedance vs Frequency for Z5U Dielectric

World Sales Headquarters
P.O. Box 5928 • Greenville, SC 29606 • www.kemet.com
Phone: (864) 963-6300 • Fax: (864) 963-6521

USA/Canada Locations

KEMET Electronics Corporation
26 Corporate Plaza, Suite 170
Newport Beach, CA 92660
Phone: 949-640-9320
Fax: 949-720-9807

KEMET Electronics Corporation
2359 Mission College Blvd., Suite 390
Santa Clara, CA 95054
Phone: 408-986-0424
Fax: 408-986-1442

KEMET Electronics Corporation
Schaumburg Corporate Center
Suite 350, 1515 Woodfield Road
Schaumburg, IL 60173
Phone: 847-517-1030
Fax: 847-517-1037

KEMET Electronics Corporation
301 Edgewater Place, Suite 208
Wakefield, MA 01880
Phone: 781-245-4646
Fax: 781-245-1595

KEMET Electronics Corporation
Piedmont Center East, Suite 410
B-137, 37 Villa Road
Greenville, SC 29615
Phone: 864-242-5789
Fax: 864-242-5795

KEMET Electronics Corporation
8445 Freeport Parkway, Suite 320
Irving, TX 75063
Phone: 972-870-9530
Fax: 972-870-9537

KEMET Electronics Canada Ltd.
105-7145 West Credit Ave., Bldg. #2
Mississauga, L5N 6J7, ON
Canada
Phone: 905-542-7930
Fax: 905-542-7949

KEMET Electronics Canada Ltd.
65 boul. Brunswick, Suite 214
Dollard-des-Ormeaux, QC
Canada
Phone: 514-685-3773
Fax: 514-685-4077

Europe/Africa Locations

KEMET Electronics S.A.R.L.
2, Rue Nicolas Ledoux
Silic 254
94568 Rungix Cedex
France
Phone: 33-1-4512-5320
Fax: 33-1-4687-4087

KEMET Electronics GmbH
Postfach 1380
D85531 Haar/Munich
Germany
Phone: 49-89-456-4200
Fax: 49-89-460-4117

KEMET Electronics S.A.
1-3, Avenue de la Paix
P.O.B. 76
CH-1211 Geneva 20,
Switzerland
Phone: 41-22-715-0100
Fax: 41-22-715-0170

KEMET Electronics Ltd.
Waterfront House, 55/61 South St.
Bishop's Stortford
Hertfordshire, CM23 3AL
United Kingdom
Phone: 44-1279-75-7343
Fax: 44-1279-75-7188

Aviv Electronics Ltd.
Hayetzira St. No. 4
P.O. Box 2433
Ra'anana, 43100
Israel
Phone: 972-9-748-3232
Fax: 972-9-741-6510

Multitech Electronics Corporation PTY
P.O. Box 23351
Claremont 7735, South Africa
Phone: 27-21-64-4103
Fax: 27-21-64-1360

Arrow Altech Distribution PTY LTD
53 - 57 Yaldwyn Road
Hughes Ext.
Jet Park 1459
South Africa
Phone: 27-11-923-9600
Fax: 27-11-923-9884

Asia Locations

KEMET Electronics (Shanghai) Co., Ltd.
2/F, No. 7 Bldg., 330 Xlyu Rd.
Waigaoqiao Free Trade Zone
Pudong, Shanghai 200137, China
Phone: 86-21-5046-0983
Fax: 86-21-5046-0981

KEMET Electronics Asia Ltd.
(Beijing Representative Office)
Suite 1512, 15/F, Lucky Tower B
3 Dong San Huan Bei Rd., Chao Yang District
Beijing, 100027, China
Phone: 86-10-6462-0173
Fax: 86-10-6461-5707

KEMET Electronics Asia Ltd.
4A Chuan Hing Industrial Bldg.
14 Wang Tai Road
Kowloon Bay, Hong Kong
Phone: 852-2305-1168
Fax: 852-2759-0345

KEMET Electronics Marketing PTE Ltd.
8-2-04, Sunny Point Kompleks, Jalan
Batu Uban, 11700 Penang
Penang, Malaysia
Phone: 60-4-6595200
Fax: 60-4-6595220

KEMET Electronics Marketing PTE Ltd.
101 Thomson Road, #23-03
United Square
Singapore, 307591, Singapore
Phone: 65-353-6636
Fax: 65-353-6656

KEMET Electronics Corporation
Taiwan Branch, 3-4F, No. 148, Section 4
Chung-Hsiao E. Rd.
Taipei, Taiwan ROC
Phone: 886-2-27528585
Fax: 886-2-27213129

Bestrade Limited
28/3 Charoren Vian Road Silcom
Bangrak, Bangkok 10500, Thailand
Phone: 662-235-1613
Fax: 662-237-7132

Crusader Electronics Pty. Ltd.
Unit 3, 92 Bryant Street
Padstow, NSW 2211, Australia
Phone: 02-9792-3922
Fax: 02-9792-1446

Electronic Enterprises Private Ltd.
Post Bag No. 6367
Unit 216 Regal Industrial Estate
Acharya Donde Marg., Sewri
Bombay 400 015, India
Phone: 91-22-413-7096
Fax: 91-22-413-3341

Unicom International Corporation
702 Shinhwa Bldg., Mapo-Gu
Seoul, 121050, Korea
Phone: 82-2712-5821
Fax: 82-2712-5823