

20-33GHz Medium Power Amplifier

Preliminary

GaAs Monolithic Microwave IC in SMD leadless package

Description

The monolithic microwave IC (MMIC) in the package is a high gain broadband four-stage monolithic medium power amplifier. It is designed for a wide range of applications, from military to commercial communication systems. The circuit is manufactured with a standard PM-HEMT process: 0.25 μ m gate length, via holes through the substrate, air bridges and electron beam gate lithography.

It is supplied in a new SMD leadless chip carrier.

Main Features

- Broad band performance: 20-33GHz
- Gain = 20dB (typical)
- Output power (P_{-1dB}): 19dBm (typical)
- Return loss < -6dB
- Low DC power consumption, 300mA
- SMD leadless package
- Dimensions: 5.08 x 5.08 x 0.97 mm³

SMD Package Dimensions

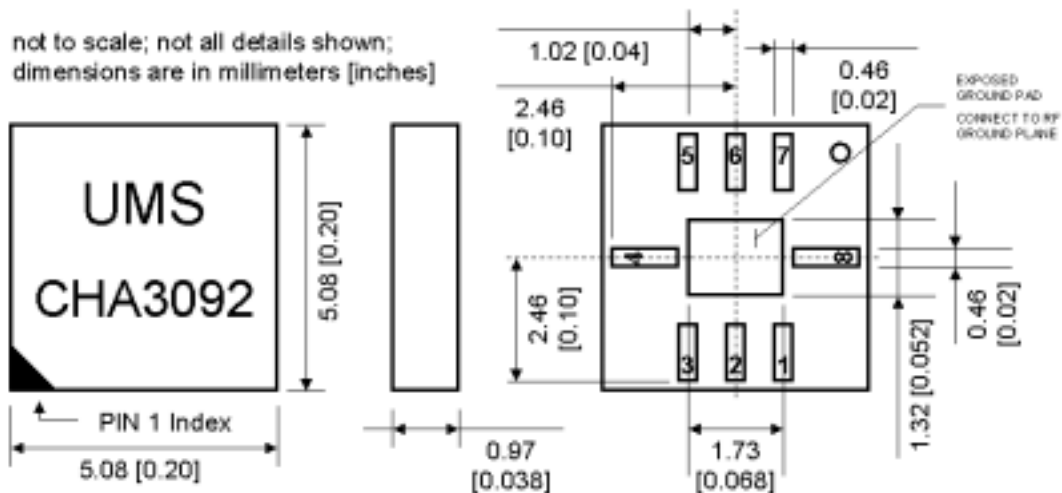

PIN	Function	PIN	Function
1	Vg1	5	NC
2	Vg2, Vg3, Vg4	6	NC
3	NC	7	Vd
4	RF out	8	RF in

"Please note that PIN 1 is located in the lower left corner of the package (front-side view) for all SMD-type packages from United Monolithic Semiconductors. It is indicated by a triangle on the package lid. Starting with PIN 1 the other pads are numbered counter-clockwise (front-side view). ATTENTION: The dot on the backside of the package (i.e. side with metallic pads) is just for fabrication purposes and does NOT indicate the location of PIN

Schematic

Preliminary

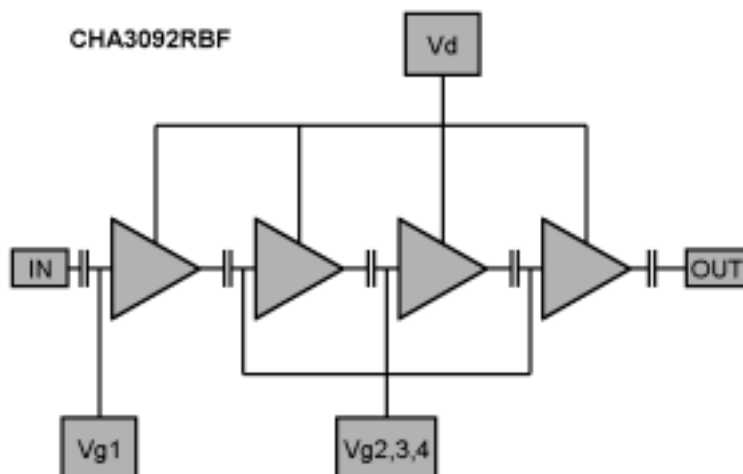

Typical Bias Conditions

for an ambient Temperature of +25°C

Symbol	Pin No.	Parameter	Values	Unit
Vd	7	Drain bias voltage	3.5	V
Vg1,2,3,4	1 & 2	First & second stages gate bias voltage	-0.2	V
Idd	7	Drain current	300	mA

All other pins are not used for this device.

Absolute Maximum Ratings

Tamb. = 25°C (1)

Symbol	Parameter	Values	Unit
Vds	Drain bias voltage_small signal (2)	4.0	V
Ids	Drain bias current_small signal	400	mA
Vgs	Gate bias voltage	-2 to +0.4	V
Vdg	Negative Drain Gate voltage (= Vds – Vgs)	+5	V
Pin	Maximum continuous input power (2) Maximum peak input power overdrive (3)	+4 +15	dBm dBm
Ta	Operating temperature range (4)	-40 to +85	°C
Tstg	Storage temperature range	-55 to +155	°C

- (1) Operation of this device above any one of these parameters may cause permanent damage.
- (2) 3.5V recommended for up to a max of 3dB gain compression.
- (3) Duration < 1s.
- (4) Upper temperature limit strongly dependent on motherboard design; ratings given for ideal thermal coupling

Typical results on PCB (recommended motherboard layout)

Vd=3.5V, Id adjusted at 300mA

Preliminary

Gain & Return Loss

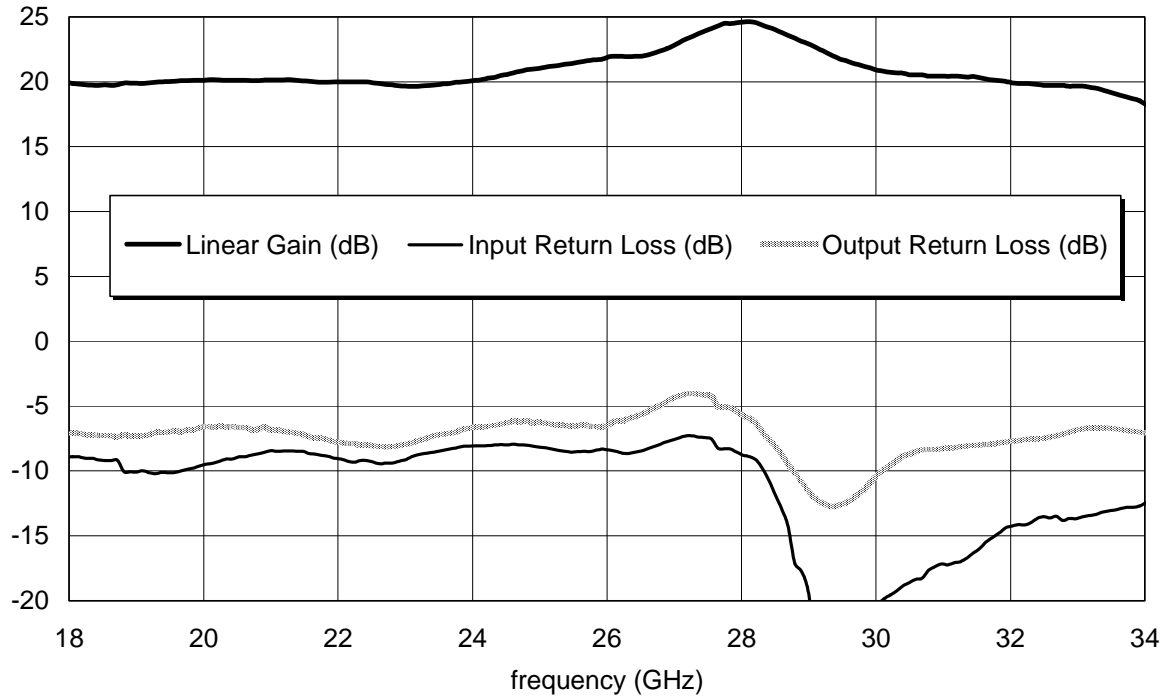

Gain versus Output Power

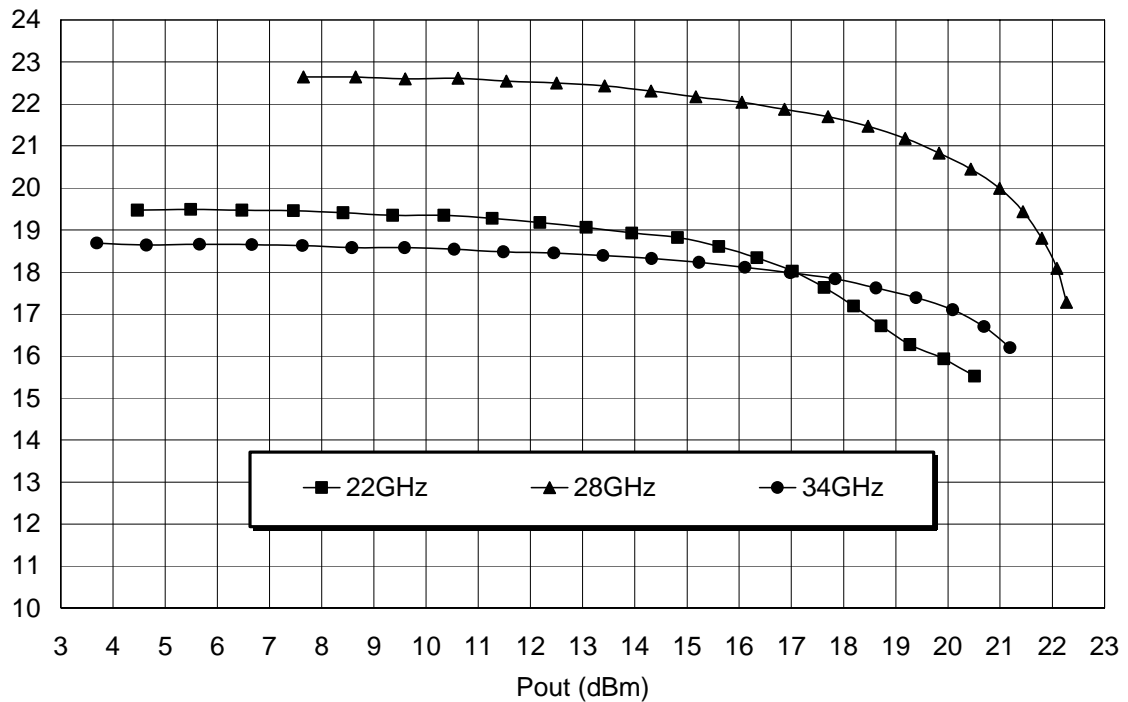

Output Power versus Gain Compression

Preliminary

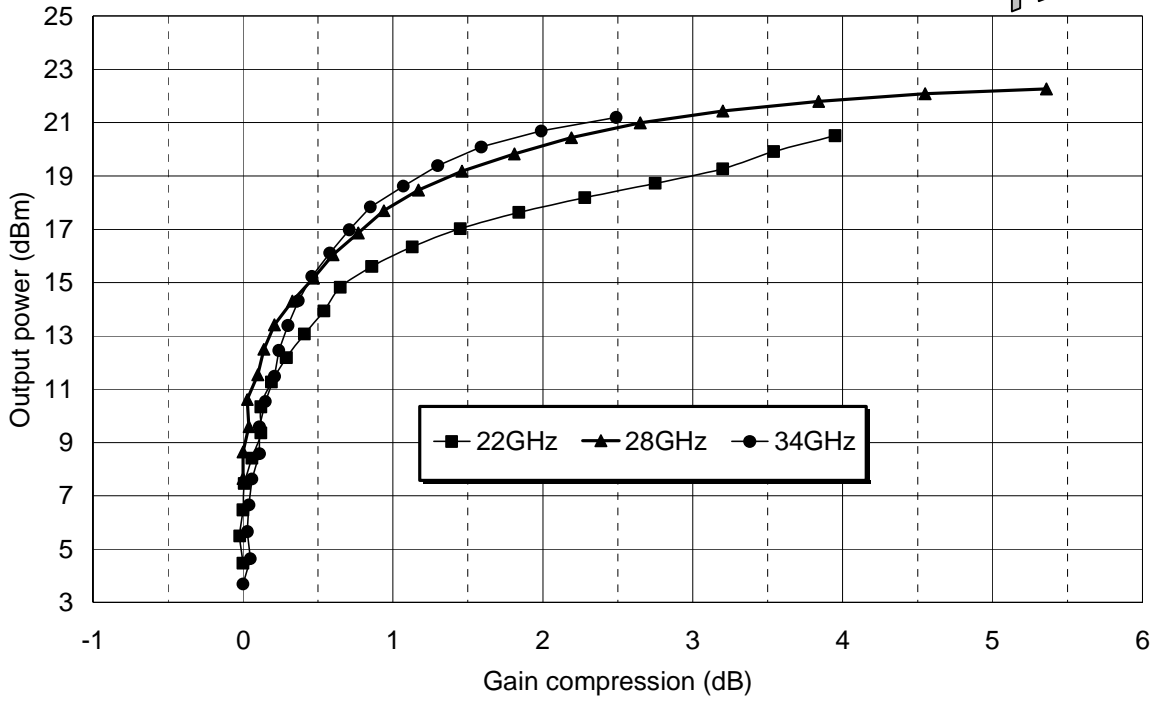

Preliminary

Footprint

Suggested PCB Footprint
for CHA3092RBF
not to scale; dimensions are
in millimeters [inches]

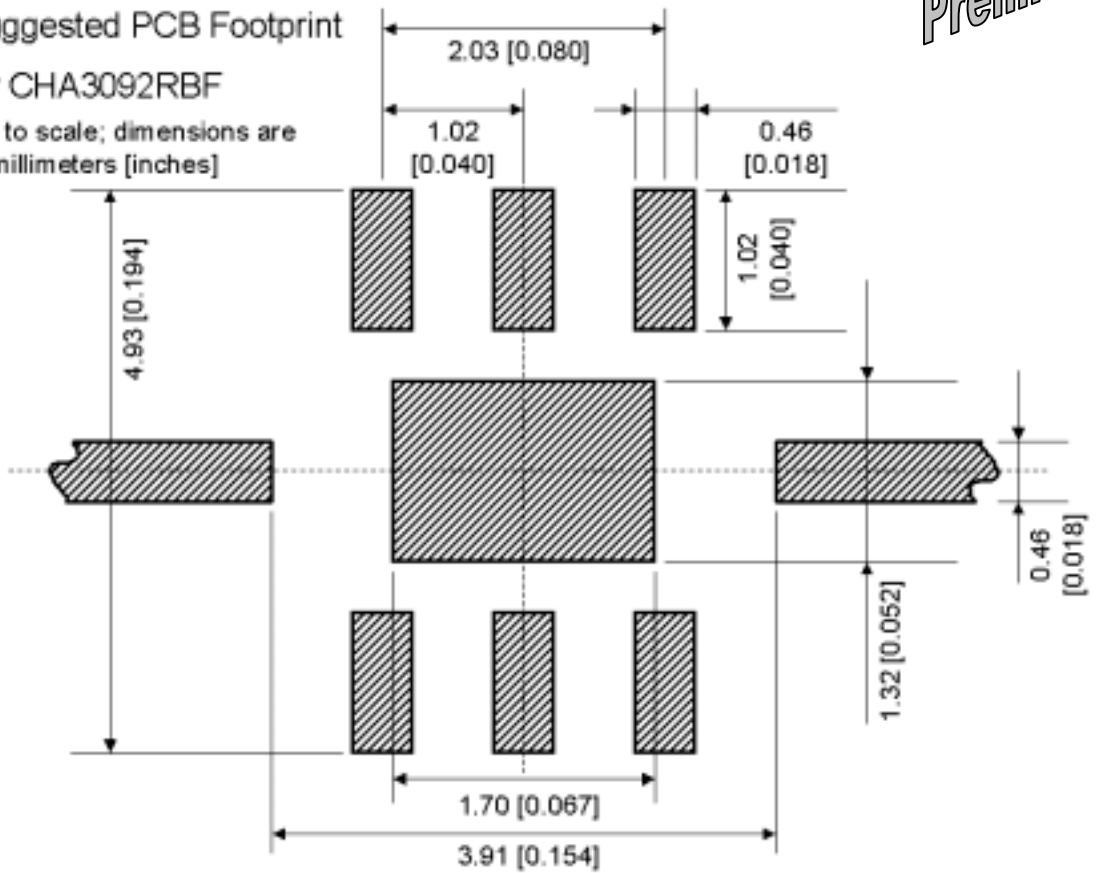

Application note

The design of the motherboard has a strong impact on the over all performance since the transition from the motherboard to the package is comparably large. In case of the SMD type packages of United Monolithic Semiconductors the motherboard should be designed according to the information given in the following to achieve good performance. Other configurations are also possible but can lead to different results. If you need advise please contact United Monolithic Semiconductors for further information.

SMD type packages of UMS should allow design and fabrication of micro- and mm-wave modules at low cost. Therefore, a suitable motherboard environment has been chosen. All tests and verifications have been performed on Rogers RO4003. This material exhibits a permittivity of 3.38 and has been used with a thickness of 200 μ m [8 mils] and a 1/2oz or less copper cladding. The corresponding 50 Ohm transmission line has a strip width of about 460 μ m [approx. 18 mils].

The contact areas on the motherboard for the package connections should be designed according to the footprint given above. The proper via structure under the ground pad is very important in order to achieve a good RF and lifetime performance. All tests have been done by using a grid of plenty plated through vias with a diameter of less than 200 μ m [8 mils] and a spacing of less than 400 μ m [16 mils] from the centres of two adjacent vias. The via grid should cover the whole space under the ground pad and the vias closest to the RF ports should be located near the edge of the pad to allow a good RF ground connection. Since the vias are important for heat transfer, a proper via filling should be guaranteed during the mounting procedure to get a low thermal resistance between package and heat sink. For power devices the use of heat slugs in the motherboard instead of a via grid is recommended.

For the mounting process the SMD type package can be handled as a standard surface mount component. The use of either solder or conductive epoxy is possible. The solder thickness after reflow should be typical 50 μ m [2 mils] and the lateral alignment between the package and the motherboard should be within 50 μ m [2 mils]. Caution should be taken to obtain a good and reliable contact over the whole pad areas. Voids or other improper connections, in particular, between the ground pads of motherboard and package will lead to a deterioration of the RF performance and the heat dissipation. The latter effect can reduce drastically reliability and lifetime of the product.

Preliminary

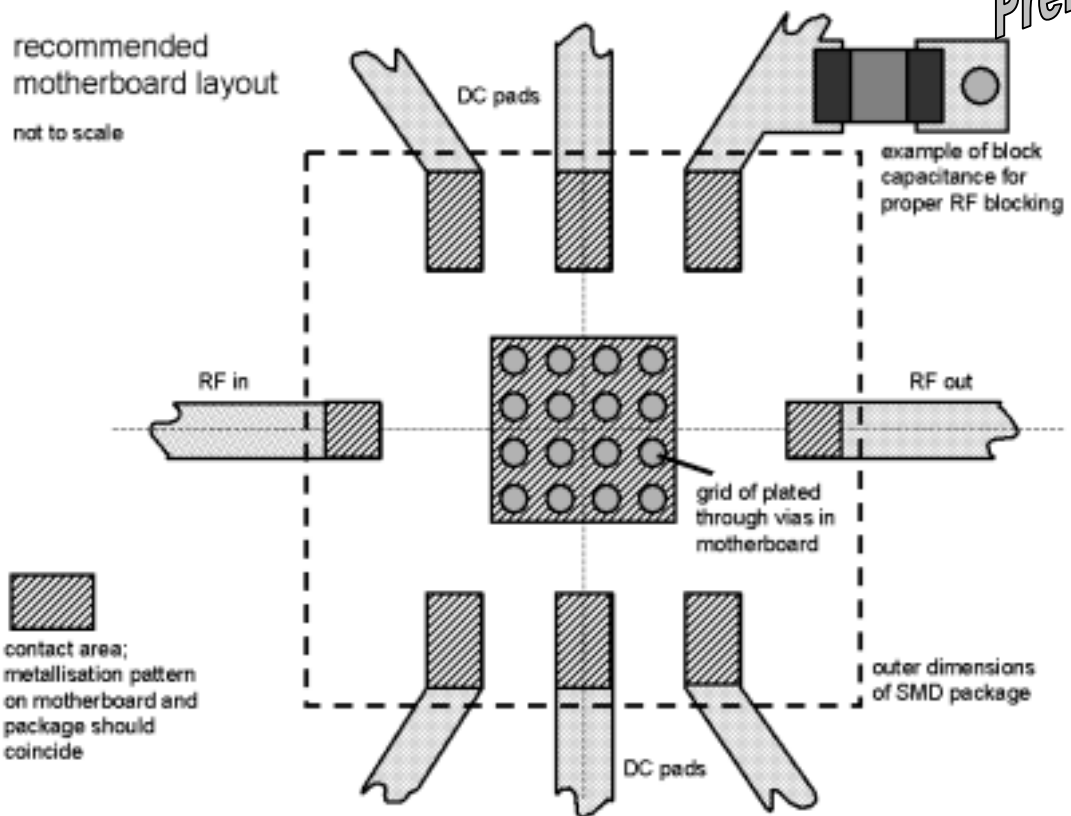

The RF ports comprise a DC blocking capacitor on chip level. The DC connections include a first level of DC decoupling capacitors (typically 120pF) in the package. However, all DC bias ports should be additionally connected to ground with 10nF capacitors at board level to prevent the MMIC from oscillations. These parts should be placed close to the SMD leadless package. If the same bias is required at different DC ports, the lines should only be connected behind these block capacitors.

Further information on the application of the SMD leadless packages for GaAs monolithic microwave ICs are given in the UMS Application Note AN0005.

Preliminary

Ordering Information

SMD leadless package form : CHA3092RBF/24

Information furnished is believed to be accurate and reliable. However **United Monolithic Semiconductors S.A.S.** assumes no responsibility for the consequences of use of such information nor for any infringement of patents or other rights of third parties which may result from its use. No license is granted by implication or otherwise under any patent or patent rights of **United Monolithic Semiconductors S.A.S.**. Specifications mentioned in this publication are subject to change without notice. This publication supersedes and replaces all information previously supplied. **United Monolithic Semiconductors S.A.S.** products are not authorised for use as critical components in life support devices or systems without express written approval from **United Monolithic Semiconductors S.A.S.**