



1N3879(R), 1N3889(R) 6/ 12/ 16FL(R) SERIES

FAST RECOVERY DIODES

Stud Version

Major Ratings and Characteristics

Parameters	1N3879-1N3883	1N3889-1N3893	6FL	12FL	16FL	Units	
$I_{F(AV)}$ @ $T_C = 100^\circ\text{C}$	6 *	12 *	6	12	16	A	
$I_{F(RMS)}$	9.5	19	9.5	19	25	A	
I_{FSM}	@ 50Hz	72	145	110	145	180	A
	@ 60Hz	75 *	150 *	115	150	190	A
I^2t	@ 50Hz	26	103	60	103	160	A ² s
	@ 60Hz	23	94	55	94	150	A ² s
$I^2\sqrt{t}$	363	856	1452	1452	2290	I ² √s	
V_{RRM} range	50 to 400 *		50 to 1000			V	
t_{rr} range	see table					ns	
T_J range	- 65 to 150					°C	

Description

This range of fast recovery diodes is designed for applications in DC power supplies, inverters, converters, choppers, ultrasonic systems and for use as a free wheeling diode.

Features

- Short reverse recovery time
- Low stored charge
- Wide current range
- Excellent surge capabilities
- Standard JEDEC types
- Stud cathode and stud anode versions
- Fully characterised reverse recovery conditions

* JEDEC registered values.

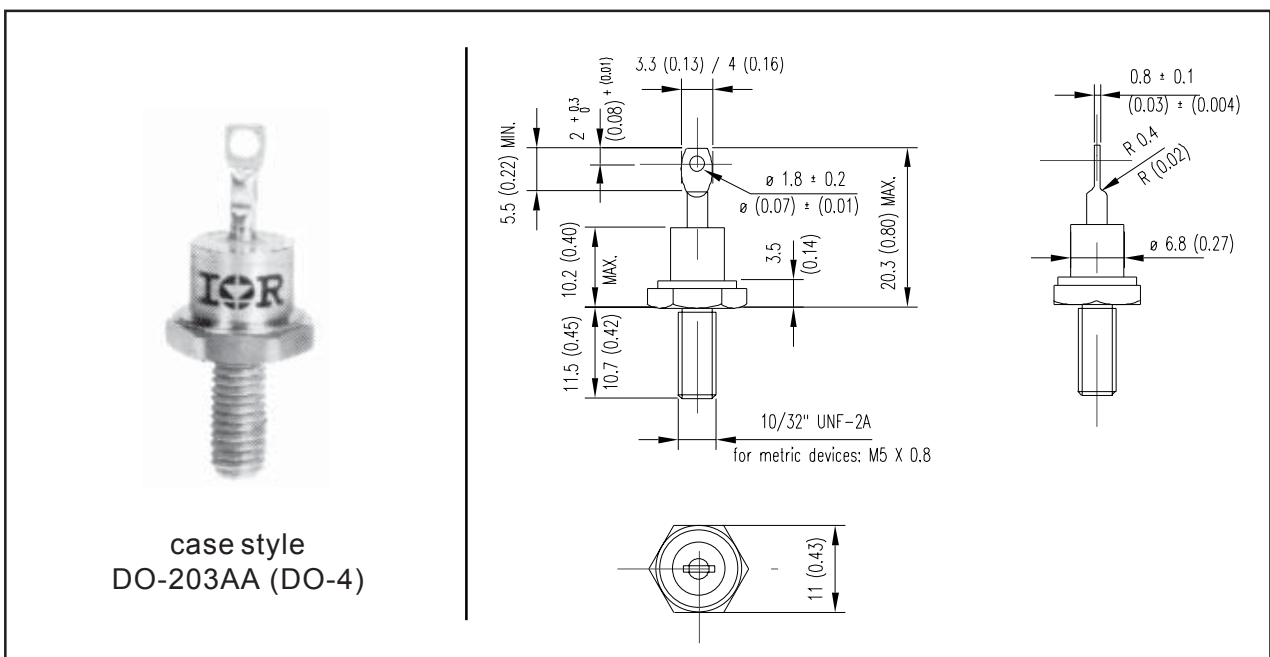

1N3879(R), 1N3889(R), 6/ 12/ 16FL(R) Series

ELECTRICAL SPECIFICATIONS

Voltage Ratings

Type number	Voltage Code	V_{RRM} max. repetitive peak and off-state voltage V	V_{RSM} maximum non-repetitive peak voltage V	I_{RRM} max. $T_J = 25^\circ\text{C}$ μA	I_{RRM} max. $T_J = 100^\circ\text{C}$ mA	I_{RRM} max. $T_J = 150^\circ\text{C}$ mA
1N3879.	-	50	75	15 *	1.0 *	3.0 *
1N3880.		100	150			
1N3881.		200	250			
1N3882.		300	350			
1N3883.		400	450			
1N3889.	-	50	75	25 *	3.0 *	5.0 *
1N3890.	-	100	150			
1N3891.	-	200	250			
1N3892.	-	300	350			
1N3893.	-	400	450			
6FL.. 12FL.. 16FL..	5	50	75	50	-	6.0
	10	100	150			
	20	200	275			
	40	400	500			
	60	600	725			
	80	800	950			
	100	1000	1250			

Forward Conduction

Parameter	1N3879. 1N3883.	6FL..	1N3889. 1N3893. 12FL..	16FL..	Units	Conditions
$I_{F(AV)}$ Max. average forward current @ $T_C = 100^\circ\text{C}$	6*	6	12 *	16	A	180° conduction, half sine wave. DC
$I_{F(RMS)}$ Max. RMS current	9.5	9.5	19	25	A	
I_{FSM} Max. peak, one-cycle non-repetitive forward current	85	130	170	215	A	t = 10ms No voltage
	90	135	180	225		t = 8.3ms reappplied
	72	110	145	180		t = 10ms 100% V_{RRM}
	75 *	115	150 *	190		t = 8.3ms reappplied
I^2t Maximum I^2t for fusing	36	86	145	230	A^2s	t = 10ms No voltage
	33	78	130	210		t = 8.3ms reappplied
	26	60	103	160		t = 10ms 100% V_{RRM}
	23	55	94	150		t = 8.3ms reappplied
I^2vt Maximum I^2vt for fusing	363	856	1452	2290	A^2vs	t = 0.1 to 10ms, no voltage reappplied
V_{FM} Max. forward voltage	1.4 *	1.4	1.4 *	1.4	V	$T_J = 25^\circ\text{C}$, $I_F = \text{rated } I_{F(AV)}$ (D.C.)
	1.5 *	1.5	1.5 *	1.5		$T_C = 100^\circ\text{C}$, $I_{FM} = \pi \times \text{rated } I_{F(AV)}$

* JEDEC registered value

1N3879(R), 1N3889(R), 6/ 12/ 16FL(R) Series

Recovery Characteristics

Parameter	1N3879. 1N3883.	1N3889. 1N3893.	6FL.. 12FL.. 16FL.. S02 S05	Units	Conditions
t_{rr} Max. reverse recovery time	150 300 *	150 300 *	... 200 500	ns	$T_J = 25^\circ\text{C}, I_F = 1\text{A to } V_R = 30\text{V}, dI_F/dt = 100\text{A}/\mu\text{s}$ $T_J = 25^\circ\text{C}, dI_F/dt = 25\text{A}/\mu\text{s}, I_{FM} = p \times \text{rated } I_{F(AV)}$
$I_{RM(REC)}$ Max. peak recovery current	4 *	5 *	...		---
Q_{RR} Max. reverse recovered charge	400 400	350 400	nC	$T_J = 25^\circ\text{C}, I_F = 1\text{A to } V_R = 30\text{V}, dI_F/dt = 100\text{A}/\mu\text{s}$ $T_J = 25^\circ\text{C}, dI_F/dt = 25\text{A}/\mu\text{s}, I_{FM} = p \times \text{rated } I_{F(AV)}$

* JEDEC registered value

Thermal and Mechanical Specification

Parameter	1N3879. 1N3883. 6FL..	1N3889. 1N3893. 12FL..	16FL..	Units	Conditions
T_J Max. junction operating temperature range	-65 to 150			°C	
T_{stg} Max. storage temperature range	-65 to 175				
R_{thJC} Max. thermal resistance, junction to case	2.5	2.0	1.6	C/W	DC operation
R_{thCS} Max. thermal resistance, case to heatsink	0.5				Mounting surface, smooth, flat and greased
T Allowable mounting torque	1.5 ^{+0-10%}			Nm	Not lubricated threads
	13			lbf.in	
	1.2 ^{+0-10%}			Nm	Lubricated threads
	10			lbf.in	
wt Approximate weight	7 (0.25)			g (oz)	
Case style	DO-203AA(DO-4)			JEDEC	

ΔR_{thJC} Conduction

(The following table shows the increment of thermal resistance R_{thJC} when devices operate at different conduction angles than DC)

	1N3879. 1N3883. 6FL..	1N3889. 1N3893. 12FL..	16FL..	1N3879. 1N3883. 6FL..	1N3889. 1N3893. 12FL..	16FL..	Units	Conditions
Conduction angle	Sinusoidal conduction			Rectangular conduction			K/W	$T_J = 150^\circ\text{C}$
180°	0.58	0.46	0.37	0.33	0.26	0.21		
120°	0.60	0.48	0.39	0.58	0.46	0.37		
60°	1.28	1.02	0.82	1.28	1.02	0.82		
30°	2.20	1.76	1.41	2.20	1.76	1.41		

1N3879(R), 1N3889(R), 6/ 12/ 16FL(R) Series

Ordering Information Table

Device Code							
A	16	F	L	R	60	M	S02
①	②	③	④	⑤	⑥	⑦	⑧

1	- Omit = Standard or Fast Recovery Diode A = Avalanche Diode
2	- Current Code $I_{(AVG)}$ = Exact Current Rating
3	- F = Diode
4	- Omit = Standard Recovery Diode L = Only for Fast Diode
5	- Omit = Stud Forward Polarity R = Stud Reverse Polarity
6	- Voltage code: Code x 10 = V_{RRM} (see Voltage Ratings table)
7	- Outlines: Omit = Stud Base UNF Thread M = Stud Base Metric Thread
8	- t_{rr} code only for Fast Diode (see Recovery Characteristics table)

Outline Table

Conforms to JEDEC DO-203AA (DO-4)
 All dimensions in millimeters

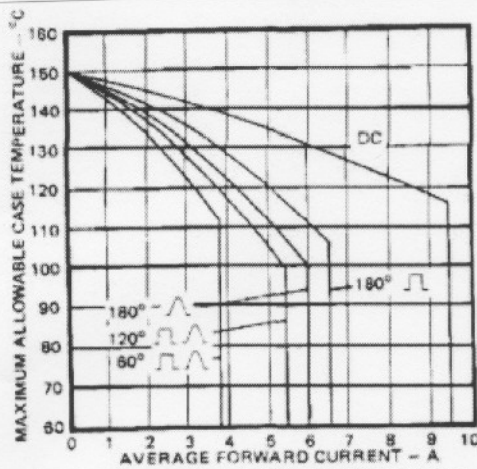

Fig. 1 - Average Forward Current Vs. Maximum Allowable Case Temperature, 1N3879 and 6FL Series

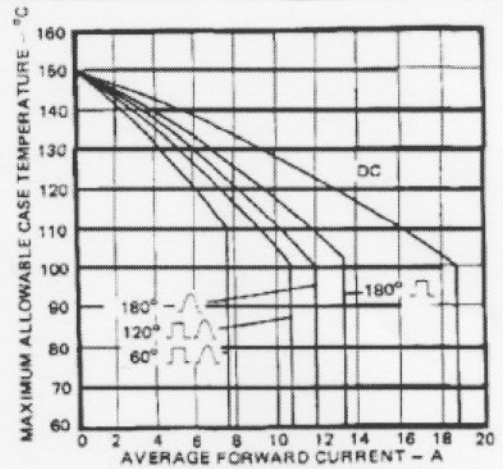

Fig. 2 - Average Forward Current Vs. Maximum Allowable Case Temperature, 1N3889 and 12FL Series

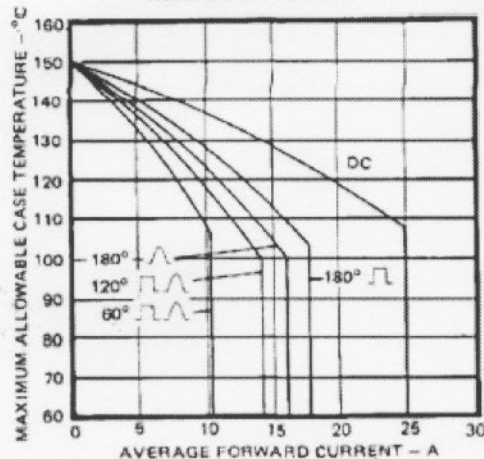
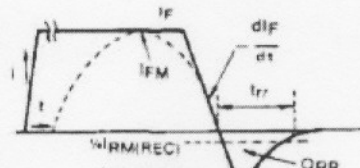
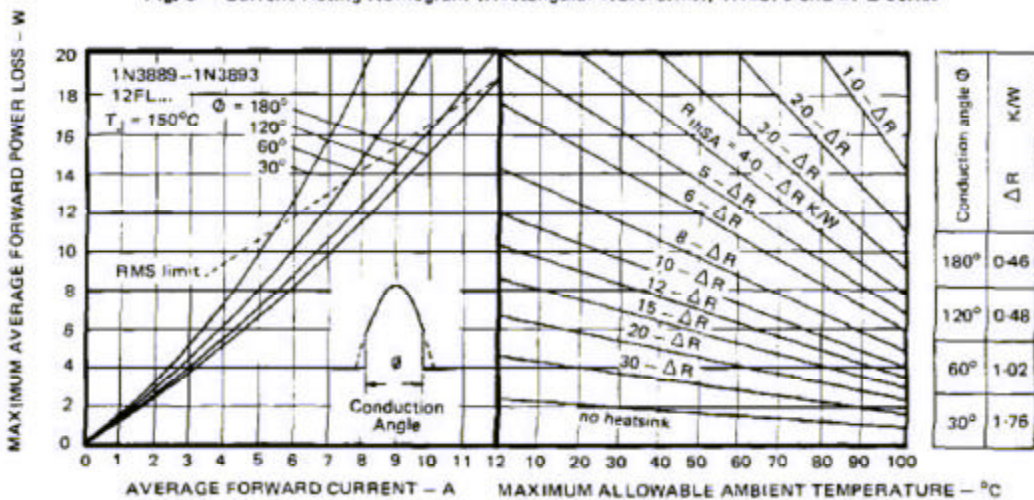
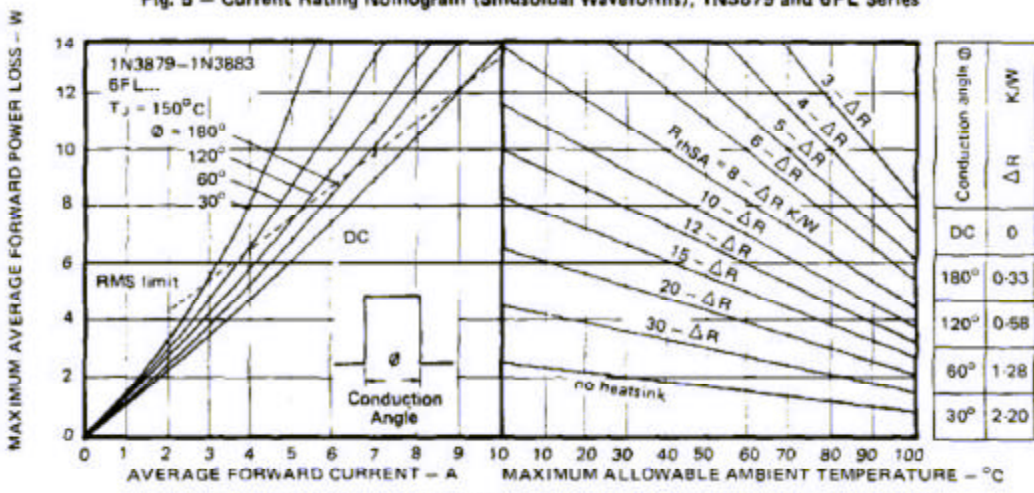
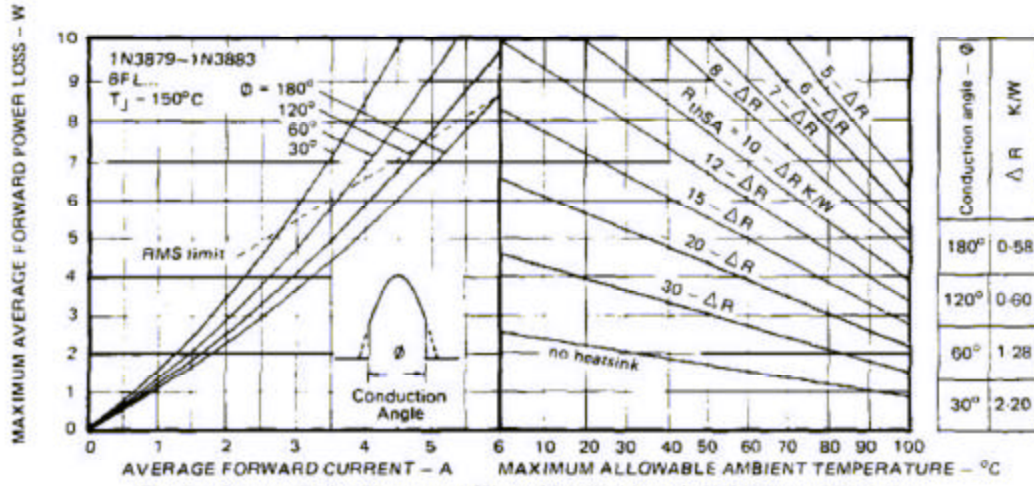

Fig. 3 - Average Forward Current Vs. Maximum Allowable Case Temperature, 16FL Series



- I_F, I_{FM} = Peak forward current prior to commutation
- $-dI_F/dt$ = Rate of fall of forward current
- $I_{RRM(REC)}$ = Peak reverse recovery current
- t_{rr} = Reverse recovery time
- Q_{RR} = Reverse recovered charge

Fig. 4 - Reverse Recovery Time Test Waveform



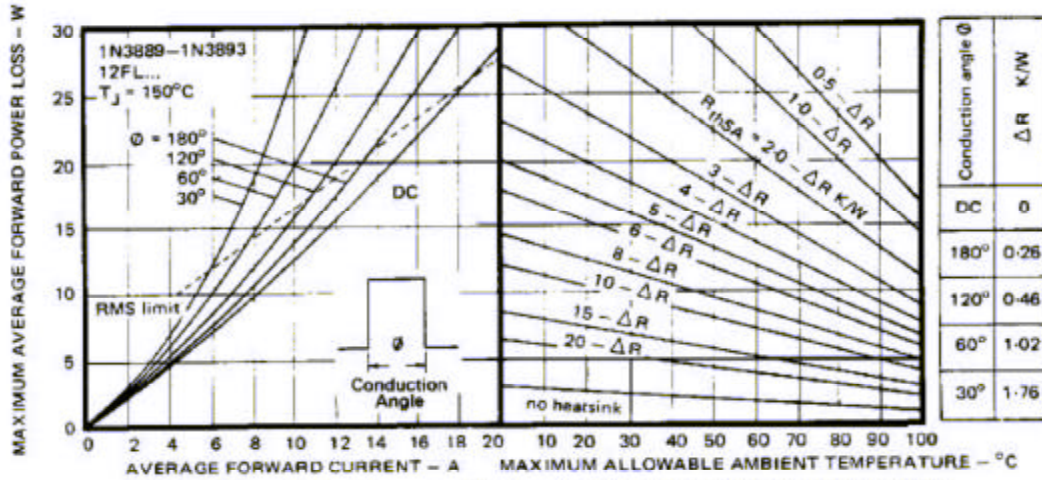

Fig. 8 - Current Rating Nomogram (Rectangular Waveforms), 1N3889 and 12FL Series

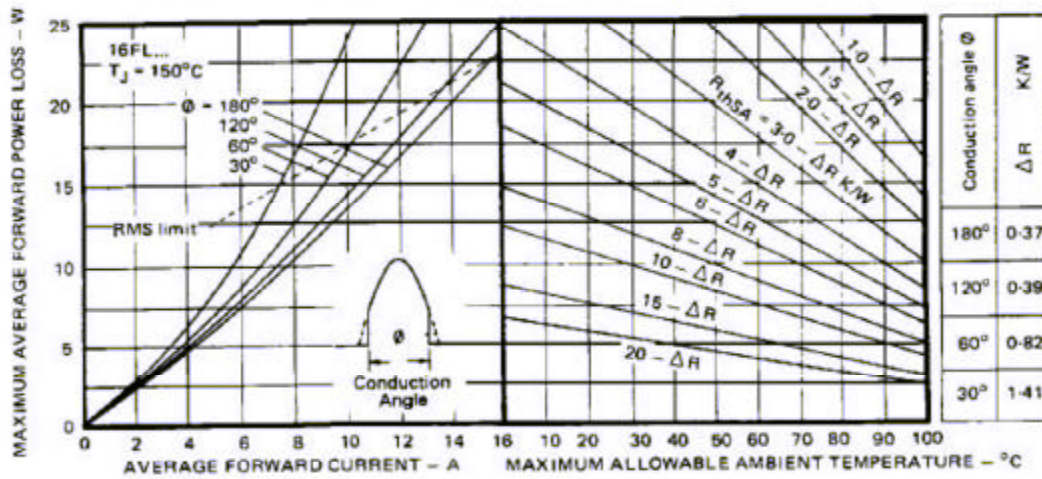

Fig. 9 - Current Rating Nomogram (Sinusoidal Waveforms), 16FL Series

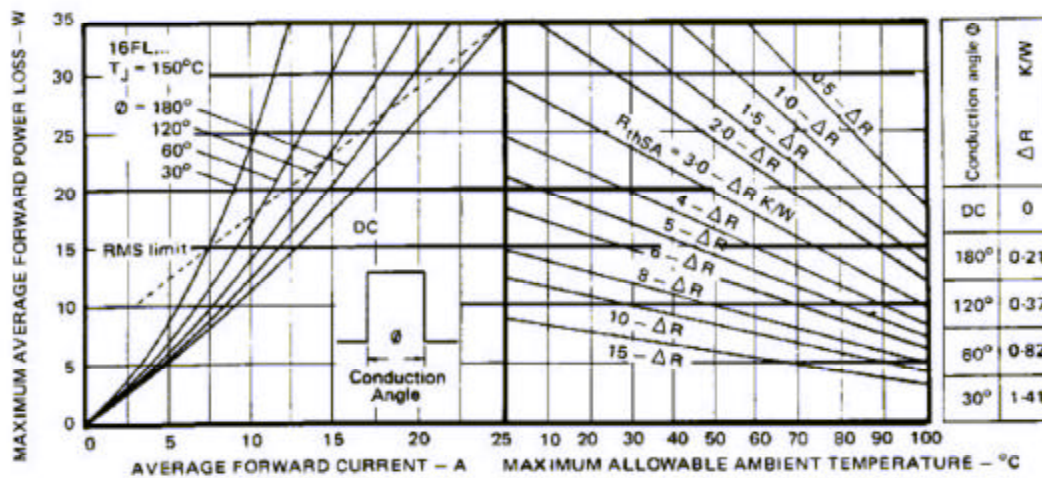

Fig. 10 - Current Rating Nomogram (Rectangular Waveforms), 16FL Series

1N3879, 1N3889, 6FL, 12FL, 16FL Series

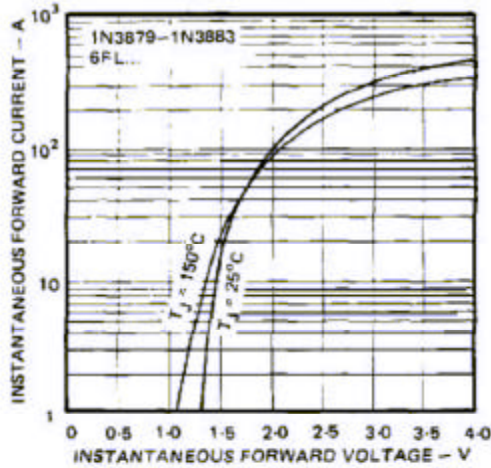

Fig. 11 - Maximum Forward Voltage Vs. Forward Current, 1N3879 and 6FL Series

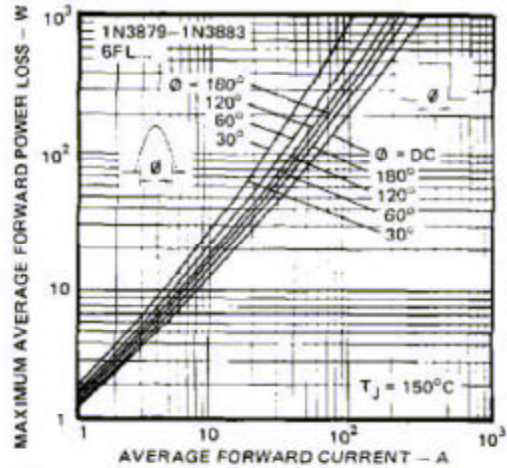

Fig. 12 - Maximum High Level Forward Power Loss Vs. Average Forward Current, 1N3879 and 6FL Series

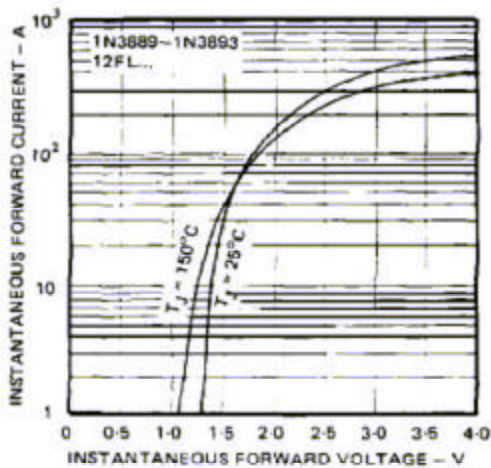

Fig. 13 - Maximum Forward Voltage Vs. Forward Current, 1N3889 and 12FL Series

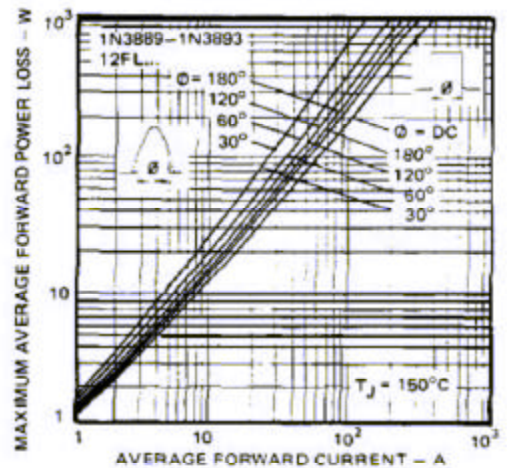

Fig. 14 - Maximum High Level Forward Power Loss Vs. Average Forward Current, 1N3889 and 12FL Series

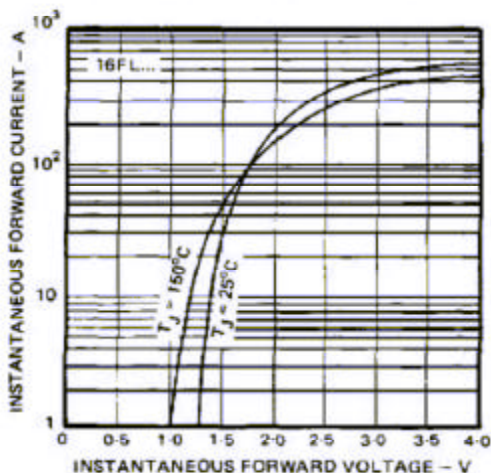

Fig. 15 - Maximum Forward Voltage Vs. Forward Current, 16FL Series

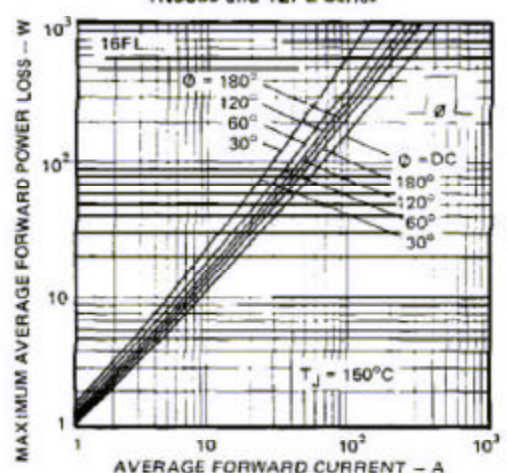

Fig. 16 - Maximum High Level Forward Power Loss Vs. Average Forward Current, 16FL Series

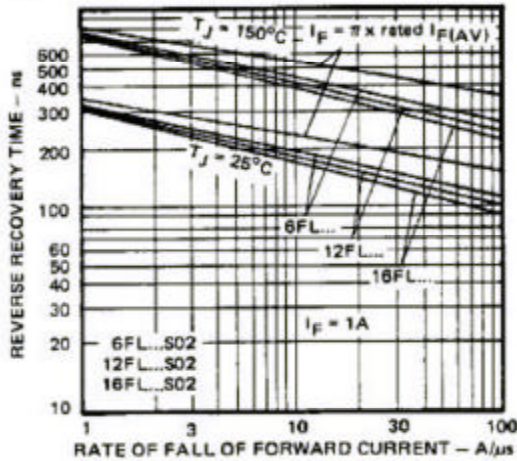

Fig. 17A — Typical Reverse Recovery Time Vs. Rate of Fall of Forward Current, All Series ___S02

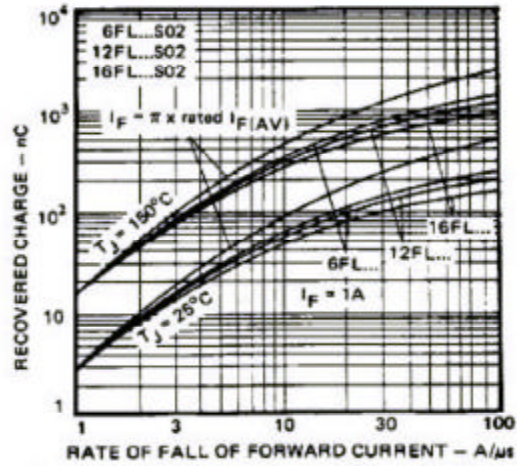

Fig. 17B — Typical Recovered Charge Vs. Rate of Fall of Forward Current, All Series ___S02

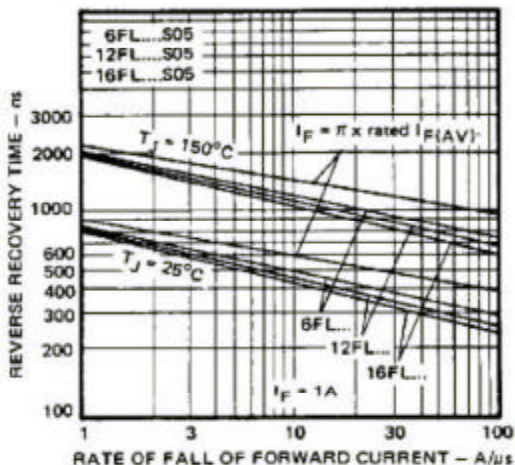

Fig. 18A — Typical Reverse Recovery Time Vs. Rate of Fall of Forward Current, All Series ___S05

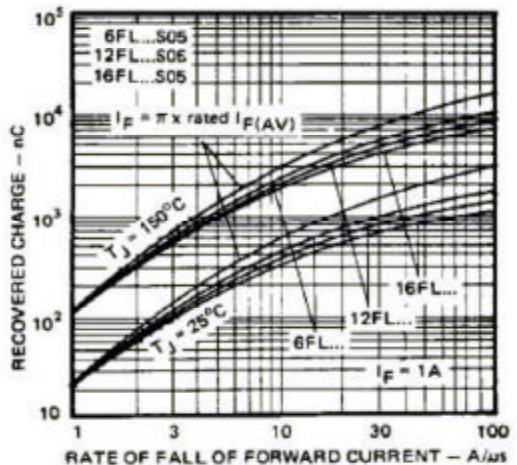

Fig. 18B — Typical Recovered Charge Vs. Rate of Fall of Forward Current, All Series ___S05

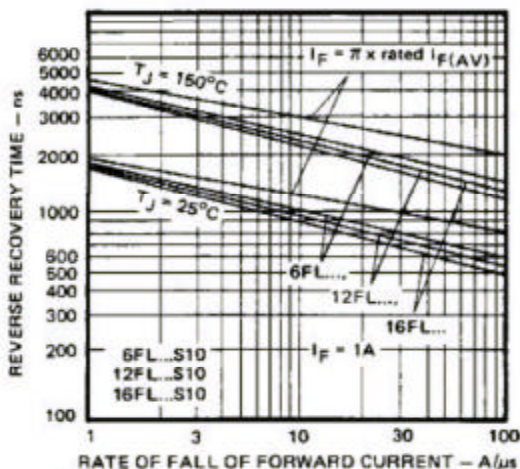

Fig. 19A — Typical Reverse Recovery Time Vs. Rate of Fall of Forward Current, All Series ___S10

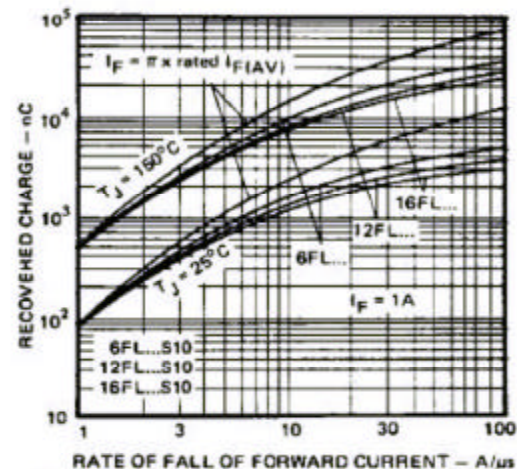

Fig. 19B — Typical Recovered Charge Vs. Rate of Fall of Forward Current, All Series ___S10

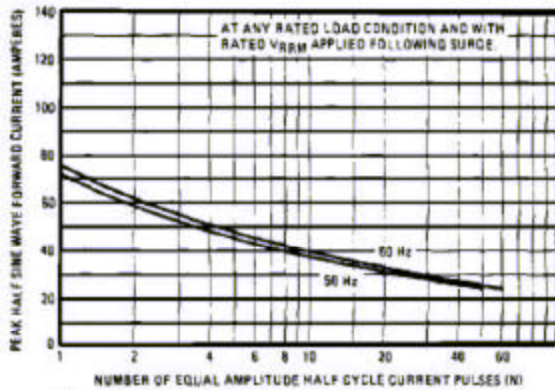

Fig. 20 – Maximum Non-Repetitive Surge Current Vs. Number of Current Pulses, 1N3879 Series

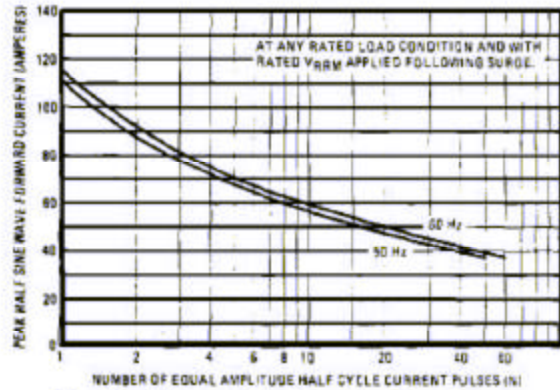

Fig. 21 – Maximum Non-Repetitive Surge Current Vs. Number of Current Pulses, 6FL Series

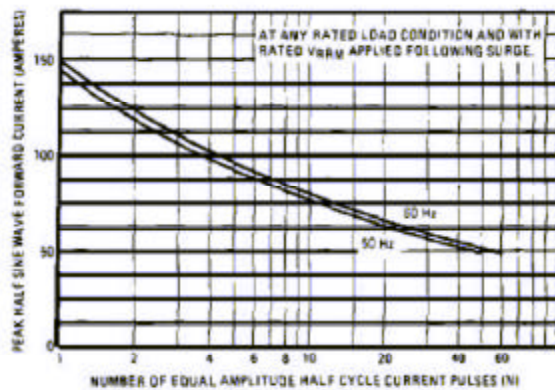

Fig. 22 – Maximum Non-Repetitive Surge Current Vs. Number of Current Pulses, 1N3889 and 12FL Series

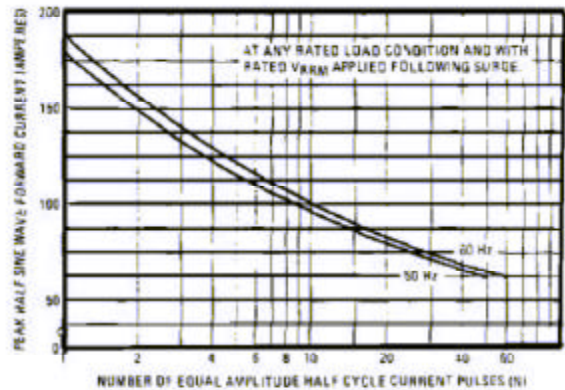

Fig. 23 – Maximum Non-Repetitive Surge Current Vs. Number of Current Pulses, 16FL Series

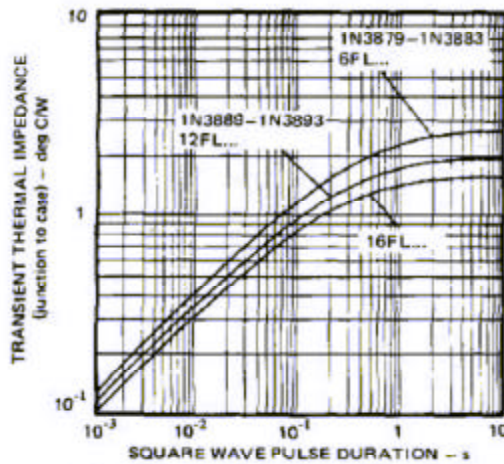

Fig. 24 – Maximum Transient Thermal Impedance, Junction-to-Case Vs. Pulse Duration, All Series.