

# NAIS

## 2 Form A slim power relay

# LA RELAYS

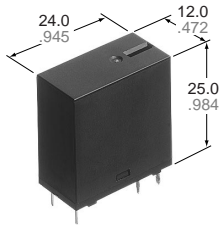

mm inch

### FEATURES

#### 1. 2 Form A slim type

24(L) × 12(W) × 25(H) mm  
.945(L) × .472(W) × .984(H) inch

#### 2. 3A type and 5A TV type

3A type: Contact reliability and break performance best suited for protecting and switching speakers.

5A TV type: Tough against inrush current and optimal for turning on and off the power supply. Rated TV-4 (UL/CSA).

#### 3. High insulation resistance

• Creepage distance and clearances be-

tween contact and coil: Min. 6 mm .236 inch (In compliance with IEC65)

• Surge withstand voltage between contact and coil: 10,000 V or more.

#### 4. High noise immunity realized by the card separation structure between contact and coil

#### 5. Conforms to the various safety standards

• UL/CSA, VDE, TÜV, SEMKO, SEV approved

### SPECIFICATIONS

#### Contact

Type	3A rated	5A TV rated
Arrangement	2 Form A	
Initial contact resistance, max. (By voltage drop 6 V DC 1 A)	Max. 50 mΩ	Max. 100 mΩ
Contact material	Gold-clad silver alloy	Silver alloy
Rating (resistive load)	Nominal switching capacity	3 A 125 V AC    5 A 277 V AC
	Max. switching power	625 VA    1,385 V A
	Max. switching voltage	125 V AC    277 V AC
	Max. switching current	5 A (AC)
Expected life (min. operations)	Mechanical (at 180 cpm)	10 <sup>6</sup>
	Electrical (at 20 cpm) (at rated load)	5 × 10 <sup>4</sup> (ON: OFF=1.5s: 1.5s)

#### Coil

Nominal operating power	530 mW
-------------------------	--------

#### Remarks

- \* Specifications will vary with foreign standards certification ratings.
- \*1 Measurement at same location as "Initial breakdown voltage" section.
- \*2 Detection current: 10mA
- \*3 Wave is standard shock voltage of ±1.2 × 50ms according to JEC-212-1981
- \*4 Excluding contact bounce time.
- \*5 Half-wave pulse of sine wave: 11 ms; detection time: 10 μs
- \*6 Half-wave pulse of sine wave: 6 ms
- \*7 Detection time: 10 μs
- \*8 Refer to 5. Conditions for operation, transport and storage mentioned in AMBIENT ENVIRONMENT (Page 61).

#### Characteristics

Type	3A rated	5A TV rated
Max. operating speed	20 cpm	
Initial insulation resistance*1	Min. 1,000 MΩ (at 500 V DC)	
Initial *2 breakdown voltage	Between contact sets	1,000 Vrms for 1 min.
	Between open contacts	1,000 Vrms for 1 min.
	Between contact and coil	4,000 Vrms for 1 min.
Surge voltage between contact and coil*3	Min. 10,000 V	
Operate time*4 (at nominal voltage)	Max. 15ms (at 20°C 68°F)	
Release time (with diode)*4 (at nominal voltage)	Max. 15ms (at 20°C 68°F)	
Temperature rise (at 70°C)	Max. 45°C with nominal coil voltage and at 3 A contact carrying current	Max. 45°C with nominal coil voltage and at 5 A contact carrying current
Shock resistance	Functional*5	Min. 200 m/s <sup>2</sup> {approx. 20 G}
	Destructive*6	Min. 1,000 m/s <sup>2</sup> {approx. 100 G}
Vibration resistance	Functional*7	10 to 55Hz at double amplitude of 1.5mm
	Destructive	10 to 55Hz at double amplitude of 1.5mm
Conditions for operation, transport and storage*8 (Not freezing and condensing at low temperature)	Ambient temp.	-40°C to +70°C -40°F to +158°F
	Humidity	5 to 85% R.H.
	Air pressure	86 to 106 kPa
Unit weight	Approx. 13 g .46 oz	

### ORDERING INFORMATION

Ex. A LA 2 P F 12

Product name	Contact arrangement	Contact capacity	Protective construction	Coil voltage(V DC)
LA	2: 2 Form A	Nil: 3A P: 5A TV-4	F: Flux-resistant type	12, 24

UL/CSA, VDE, TÜV, SEMKO, TV-4 approved type is standard.

Notes: 1. Standard packing Carton: 100 pcs. Case: 500 pcs.

2. 4.5V, 5V, 9V and 18V DC types are also available. Please consult us for details.

**TYPES AND COIL DATA (at 20°C 68°F)**

Part No.		Nominal voltage, V DC	Pick-up voltage, V DC (max.)	Drop-out voltage, V DC (min.)	Coil resistance, Ω (±10%)	Nominal operating current, mA (±10%)	Nominal operating power, mW	Maximum allowable voltage, V DC
3 A type	5A TV type							
ALA2F12	ALA2PF12	12	(Initial) 9	(Initial) 0.6	272	44.2	530	15.6
ALA2F24	ALA2PF24	24	(Initial) 18	(Initial) 1.2	1,087	22.1	530	31.2

**DIMENSIONS**

mm inch

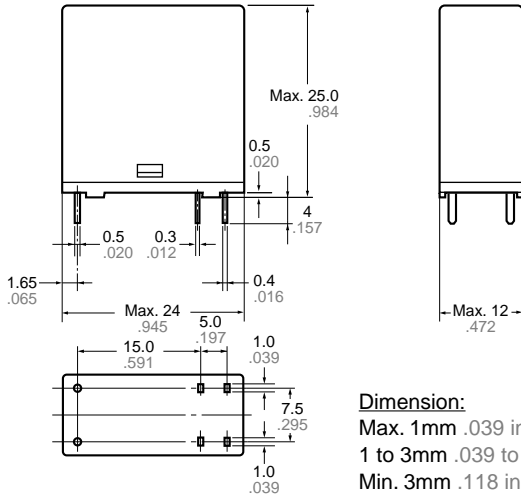

PC board pattern (Bottom view)

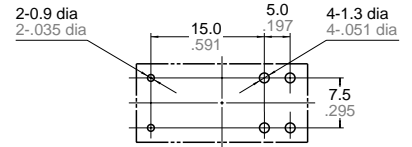

Tolerance : ±0.1 ±.004

Schematic (Bottom view)



**Dimension:**  
 Max. 1mm .039 inch:  
 1 to 3mm .039 to .118 inch:  
 Min. 3mm .118 inch:

**General tolerance**  
 ±0.1 ±.004  
 ±0.2 ±.008  
 ±0.3 ±.012

**REFERENCE DATA**

1. Max. switching power (AC resistive load)

2-(1). Life curve (250 V AC resistive load)

2-(2). Life curve (125 V AC resistive load)

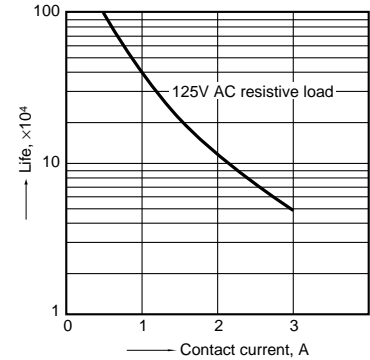
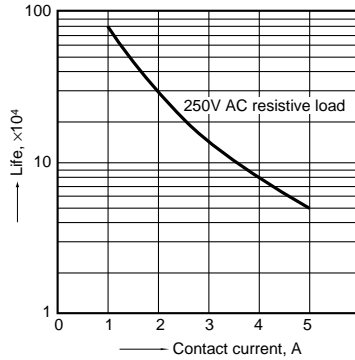
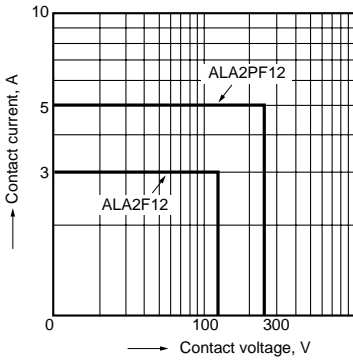

3-(1). Coil temperature rise

Sample: ALA2F12, 6 pcs.  
 Measured portion: coil inside  
 Contact current: 0 A, 3A

3-(2). Coil temperature rise

Sample: ALA2PF12, 6 pcs.  
 Measured portion: coil inside  
 Contact current: 0 A, 5A

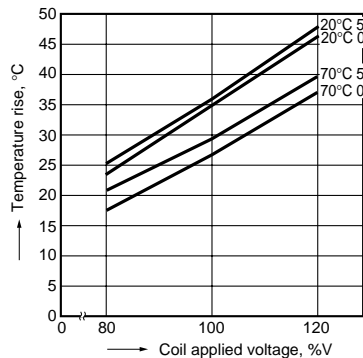
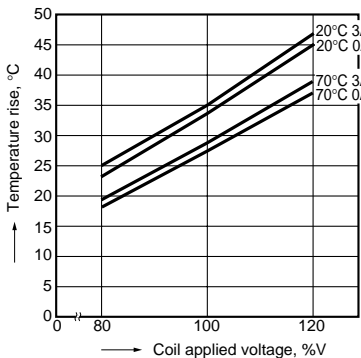

4. Ambient temperature characteristics and coil applied voltage

Contact current: ALA2F=3A  
 ALA2PF=5A

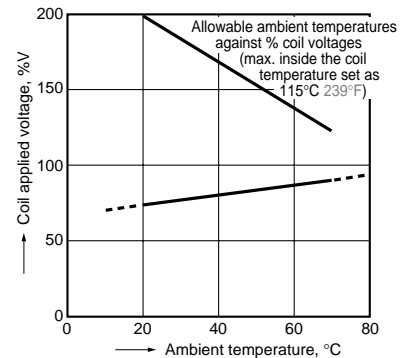

5-(1). Electrical life test  
 (3 A 125 V AC, resistive load)  
 Sample: ALA2F12, 6 pcs.  
 Operation frequency: 20 times/min.  
 (ON/OFF = 1.5s: 1.5s)  
 Ambient temperature: 20°C 68°F

Circuit:

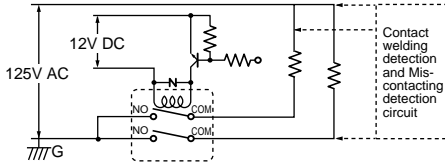

Change of pick-up and drop-out voltage

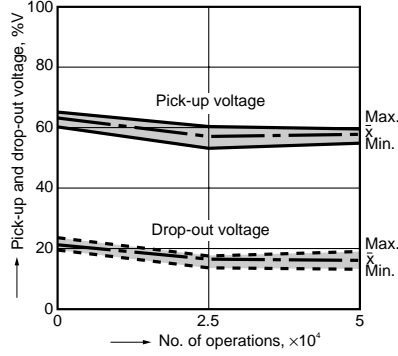

Change of contact resistance

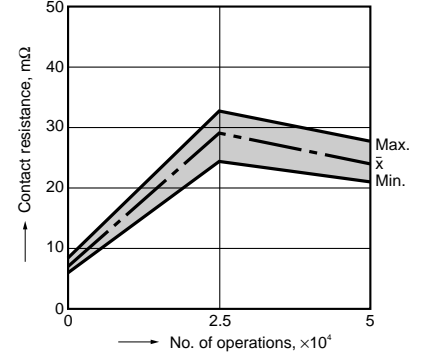

5-(2). Electrical life test  
 (5 A 250 V AC, resistive load)  
 Sample: ALA2PF12, 6 pcs.  
 Operation frequency: 20 times/min.  
 (ON/OFF = 1.5s: 1.5s)  
 Ambient temperature: 20°C 68°F

Circuit:

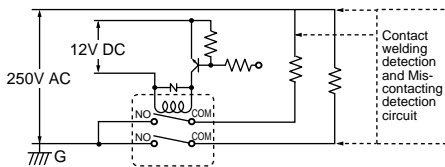

Change of pick-up and drop-out voltage

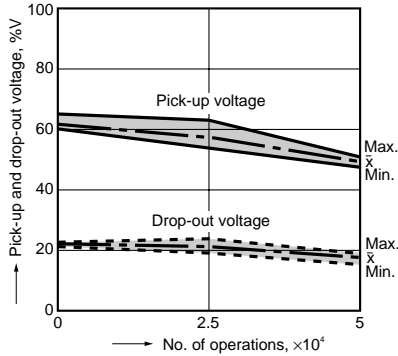

Change of contact resistance

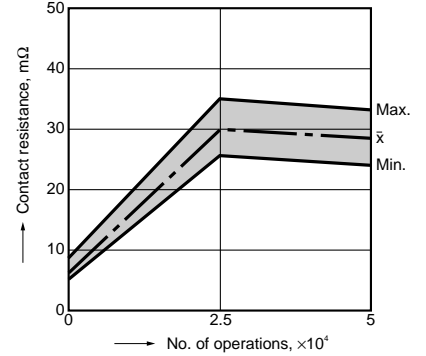

5-(3). Electrical life test  
 (UL lamp load test TV-4)

- Tested sample: ALA2PF12, 6 pcs.
- Overload test  
 Load: 6.0 A 120 V AC (60 Hz),  
 Inrush: 91 A  
 Operation frequency: 10 times/min  
 (ON: OFF = 1 s: 5 s)  
 No. of operations: 50 ope.
  - Endurance test  
 Load: 4A 120 V AC (60 Hz),  
 Inrush: 65 A  
 Operation frequency: 10 times/min  
 (ON: OFF = 1 s: 5 s)  
 No. of operations: 25,000 ope.

Change of pick-up and drop-out voltage

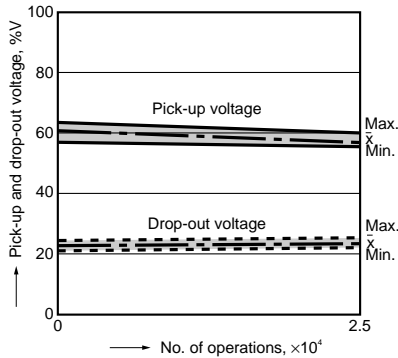

Change of contact resistance

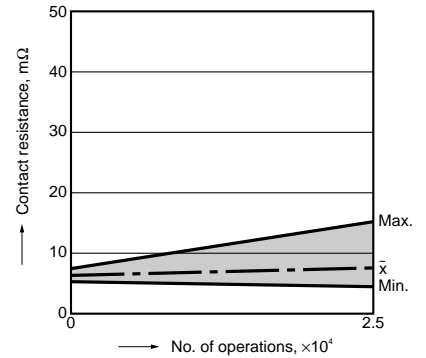

**For Cautions for Use, see Relay Technical Information (Page 48 to 76).**