

General Description

The AAT2805 is a dual charge pump designed to support both the white LED backlight and flash applications for systems operating with lithium-ion/polymer batteries. The backlight charge pump is capable of driving up to four LEDs at a total of 120mA. The current sinks may be operated individually or in parallel for driving higher current LEDs. To maximize power efficiency, the charge pump operates in 1X, 1.5X, or 2X mode, where the mode of operation is automatically selected by comparing the forward voltage of each LED with the input voltage. AnalogicTech's AS²Cwire™ (Advanced Simple Serial Control™) serial digital input is used to enable, disable, and set current for each LED with a 16-level logarithmic scale plus four low-current settings down to 50µA for optimized efficiency, with a typical operating quiescent current of less than 50µA.

The flash charge pump is a charge pump doubler with a regulated output voltage. It is designed to deliver 120mA of continuous current and up to 250mA of pulsed current. It has an independent enable pin for improved power savings.

The AAT2805 has thermal protection and built-in soft-start circuitry. A low-current shutdown feature disconnects the load from V_{IN} and reduces quiescent current to less than 1µA.

The AAT2805 is available in a space-saving, thermally-enhanced TDFN44-16 package and is rated over the -40°C to +85°C temperature range.

Features

- V_{IN} Range: 2.7V to 5.5V
- Dual Charge Pump to Support Backlight and Flash LEDs
- Backlight Charge Pump:
 - Regulated Current
 - Four Current Sink Inputs
 - AS²Cwire Brightness Control
 - Tri-Mode Charge Pump
 - Maximum 30mA of Current Per Input
 - Low I_Q (50µA) in Light Load Mode
- Flash Charge Pump:
 - Regulated Output Voltage
 - Up to 250mA of Pulsed Current
- Independent Backlight/Flash Control
- Low Noise 1MHz Constant Frequency Operation
- Automatic Soft-Start
- No Inductors
- Available in TDFN44-16 Package

Applications

- Color (RGB) Lighting
- White LED Backlighting
- White LED Photo Flash

Typical Application

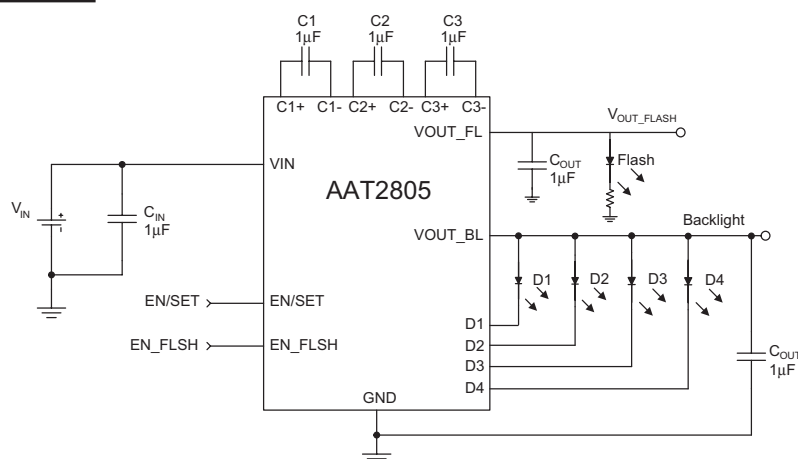

Pin Descriptions

Pin #	Symbol	Function
1	C3-	Flying capacitor 3 negative terminal.
2	C3+	Flying capacitor 3 positive terminal. Connect a 1 μ F capacitor between C3+ and C3-.
3	VOUT_FL	Regulated output voltage for flash LED. Requires 1 μ F capacitor connected between this pin and ground.
4	VIN	Input power supply. Requires 1 μ F capacitor connected between this pin and ground.
5	D4	Current sink input 4.
6	D3	Current sink input 3.
7	D2	Current sink input 2.
8	D1	Current sink input 1.
9	GND	Ground.
10	EN/SET	AS ² Cwire serial interface control pin. It is used to enable/disable the backlight charge pump and to control the brightness of the white LEDs.
11	C1+	Flying capacitor 1 positive terminal. Connect a 1 μ F capacitor between C1+ and C1-.
12	C1-	Flying capacitor 1 negative terminal.
13	VOUT_BL	Regulated output voltage for white LED. Requires 1 μ F capacitor connected between this pin and ground.
14	C2+	Flying capacitor 2 positive terminal. Connect a 1 μ F capacitor between C2+ and C2-.
15	C2-	Flying capacitor 2 negative terminal.
16	EN_FLSH	Enable/disable pin for the flash charge pump.
EP		Exposed paddle (bottom); connect to GND directly beneath package.

Pin Configuration

**TDFN44-16
(Top View)**

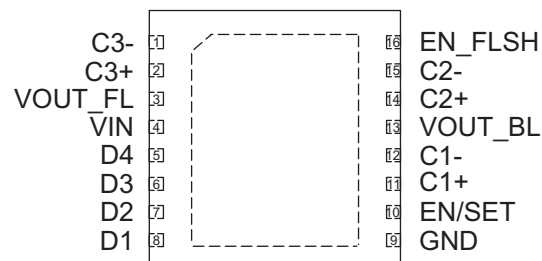

Absolute Maximum Ratings¹

Symbol	Description	Value	Units
V_{IN}	Input Voltage	-0.3 to 6.0	V
$V_{EN/SET}; EN_FL$	EN/SET; EN_FL to GND Voltage	-0.3 to $V_{IN} + 0.3$	V
T_{LEAD}	Maximum Soldering Temperature (at leads, 10 sec)	300	°C

Thermal Information

Symbol	Description	Value	Units
P_D	Maximum Power Dissipation ^{2, 3}	2.0	W
θ_{JA}	Maximum Thermal Resistance ²	50	°C/W

1. Stresses above those listed in Absolute Maximum Ratings may cause permanent damage to the device. Functional operation at conditions other than the operating conditions specified is not implied. Only one Absolute Maximum Rating should be applied at any one time.
2. Mounted on an FR4 board.
3. Derate 6.25mW/°C above 25°C.

Electrical Characteristics¹

$V_{IN} = 3.6V$; $C_{IN} = C_{OUT} = C_1 = C_2 = C_3 = 1.0\mu F$; $T_A = -40^\circ C$ to $85^\circ C$ unless otherwise noted.
Typical values are at $T_A = 25^\circ C$.

Symbol	Description	Conditions	Min	Typ	Max	Units
Input Power Supply						
V_{IN}	Operation Range		2.7		5.5	V
I_{CC}	Operating Current	1X Mode, $3.0 \leq V_{IN} \leq 5.5$, Active, No Load Current; EN_FLSH = GND, EN/SET = V_{IN}		0.3	1	mA
		1.5X Mode, $3.0 \leq V_{IN} \leq 5.5$, Active, No Load Current; EN_FLSH = GND, EN/SET = V_{IN}		1.0	3.0	
		2X Mode, $3.0 \leq V_{IN} \leq 5.5$, Active, No Load Current; EN_FLSH = GND, EN/SET = V_{IN}		1.0	3.0	
		EN_FLSH = GND, 50 μA Output Setting, 1X Mode		50		μA
		$3.0 \leq V_{IN} \leq 5.5$, No Load Current; EN_FLSH = V_{IN} , EN/SET = GND		2.0	4.5	mA
I_{SHDN}	Shutdown Current	EN_FLSH = EN/SET = 0			1.0	μA
I_{DX}	Input Current Accuracy ^{2,4}	$I_{SET} = 30mA$; $T_A = 25^\circ C$	-10		10	%
$I_{(D-Match)}$	Current Matching Between Any Two Current Sink Inputs ^{2,5}	VD1:D4 = 3.6, $V_{IN} = 3.5V$		0.5		%
R_{SINK}	Sink Switch Impedance (each) ²			7		Ω
V_{OUT_FL}	Flash Charge Pump Output Voltage	$3.0V < V_{IN} < 5V$, $I_{OUT} = 100mA$; EN_FLSH = V_{IN}	4.32	4.5	4.68	V
		$3.0V < V_{IN} < 5V$, $I_{OUT} = 150mA$; EN_FLSH = V_{IN}	4.3	4.5	4.7	
I_{OUT_FL}	Maximum Continuous I_{OUT}	$V_{IN} = 3.6V$; $V_{OUT} = 4.5V$; EN_FLSH = V_{IN}	120			mA
	Maximum Pulsed I_{OUT}	$V_{IN} = 3.6V$; $V_{OUT} = 4.5V$; $I_{PULSED} < 500mS$	250			
T_{SS}	Soft-Start Time			100		μs
F_{CLK}	Clock Frequency			1.0		MHz
$V_{EN(L)}$	Enable Threshold Low				0.4	V
$V_{EN(H)}$	Enable Threshold High		1.4			V
$T_{EN/SET LO}$	EN/SET Low Time	$V_{EN/SET} < 0.6V$	0.3		75	μs
$T_{EN/SET HI}$	Minimum EN/SET High Time	$V_{EN/SET} > 1.4V$		50		ns
T_{OFF}	EN/SET Off Timeout	$V_{EN/SET} < 0.6V$			500	μs
T_{LAT}	EN/SET Latch Timeout	$V_{EN/SET} > 1.4V$			500	μs
I_I	Enable and EN/SET Input Leakage	$V_{EN/SET} = V_{EN_FLSH} = V_{IN}$	-1.0		1.0	μA

1. The AAT2805 is guaranteed to meet performance specifications over the $-40^\circ C$ to $85^\circ C$ operating temperature range and is assured by design, characterization, and correlation with statistical process controls.
2. Specification applies only to the tri-mode charge pump.
3. Specification applies only to the charge pump doubler.
4. Determined by the sum of all active channels
5. Current matching is defined as the deviation of any sink current from the average of all active channels.

Typical Characteristics—Flash Driver Charge Pump Section

Output Voltage vs. Output Current
 $(V_{OUT_FL} = 4.5V; EN_FL = V_{IN}; EN/SET = GND)$

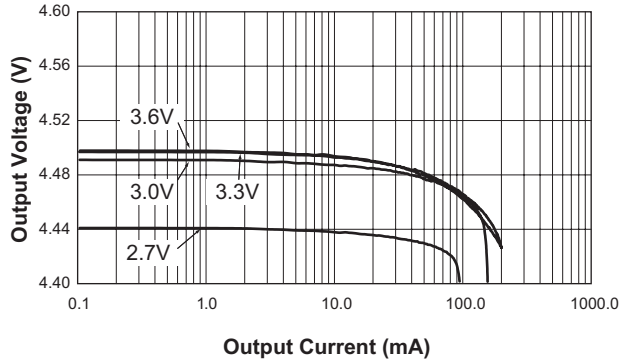

Maximum Current Pulse vs. Supply Voltage
 $(V_{OUT_FL} = 4.5V; EN_FL = V_{IN}; EN/SET = GND)$

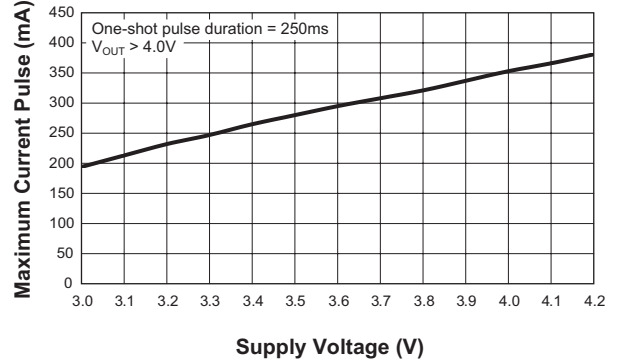

Startup Time
 (50mA Load)

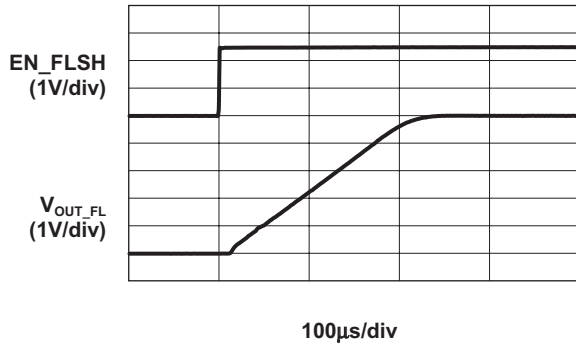

Startup Time
 (100mA Load)

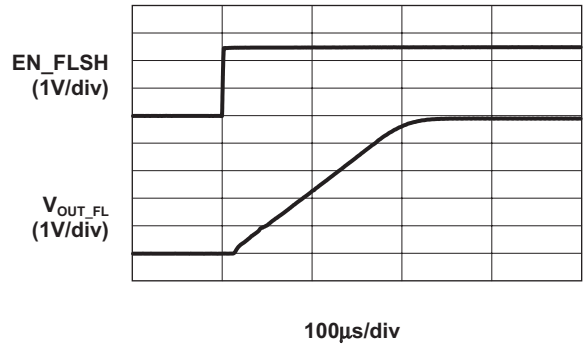

Load Response vs. Time
 (50mA Load)

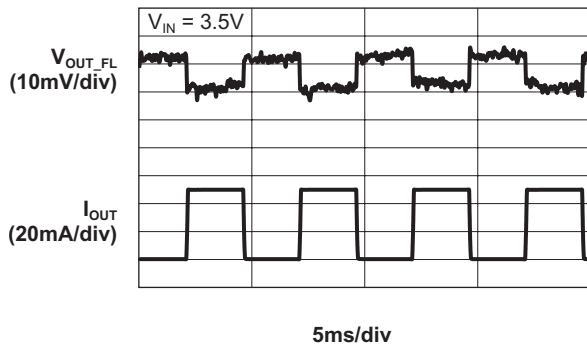

Load Response vs. Time
 (100mA Load)

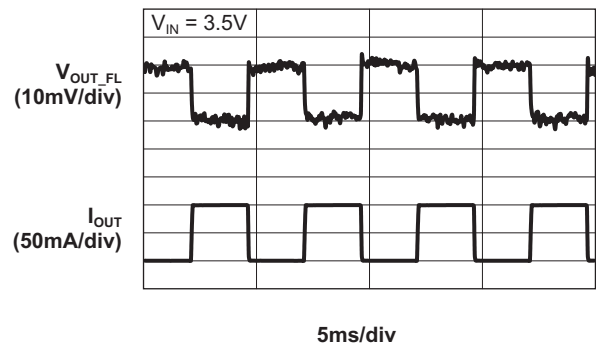

Typical Characteristics–Flash Driver Charge Pump Section

Output Ripple Voltage vs. Time
($I_{OUT} = 50\text{mA}$ @ $V_{IN} = 3.5\text{V}$)

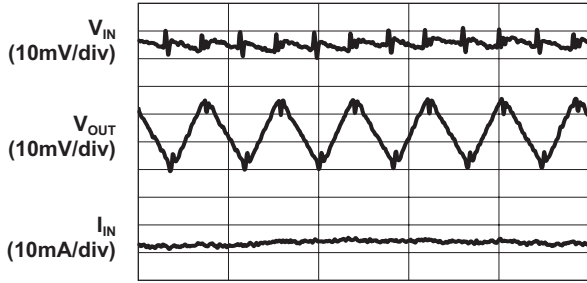

500ns/div

Output Ripple Voltage vs. Time
($I_{OUT} = 100\text{mA}$ @ $V_{IN} = 3.5\text{V}$)

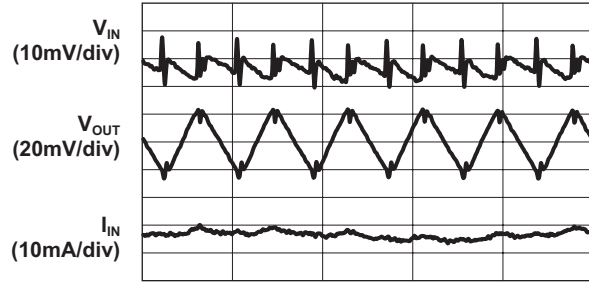

500ns/div

Supply Current vs. Supply Voltage

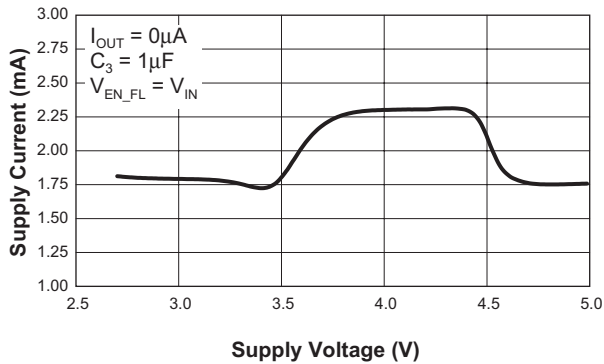

Oscillator Frequency vs. Supply Voltage

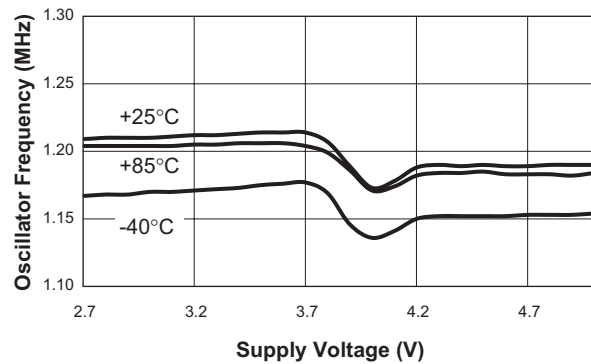

Typical Characteristics—White LED Backlight Driver Section

Turn-On to 1X Mode
($V_{IN} = 4.2V$; 20mA Load)

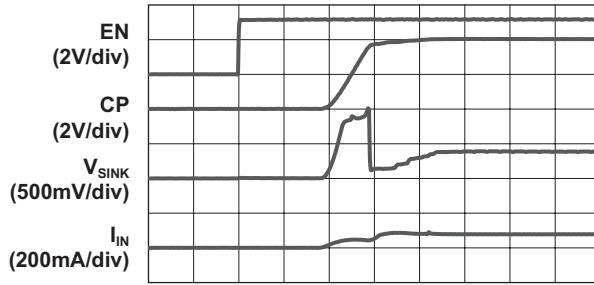

100 μ s/div

Turn-On to 1.5X Mode
($V_{IN} = 3.5V$; 20mA Load)

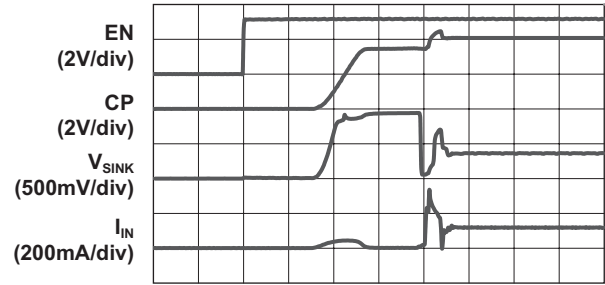

100 μ s/div

Turn-On to 2X Mode
($V_{IN} = 2.8V$; 20mA Load)

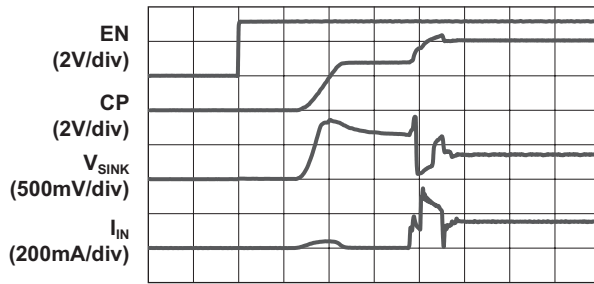

100 μ s/div

Turn-Off from 1.5X Mode
($V_{IN} = 3.5V$; 20mA Load)

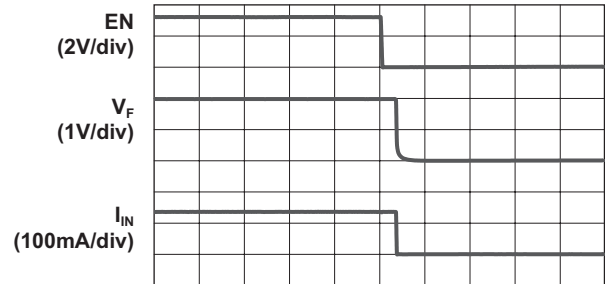

500 μ s/div

Efficiency vs. Supply Voltage

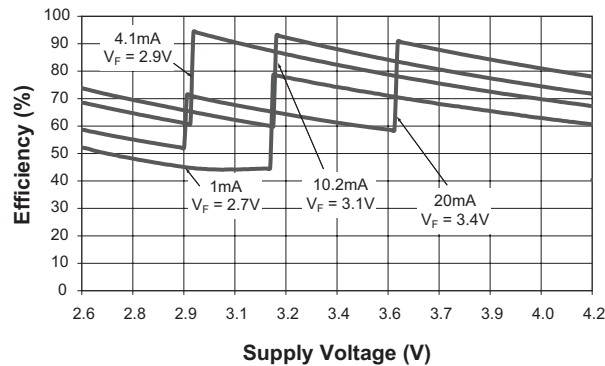

Current Matching vs. Temperature

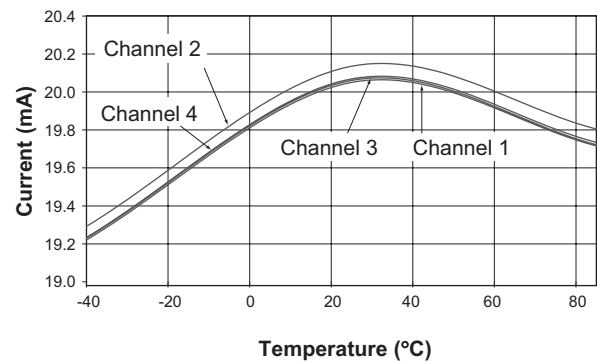

Typical Characteristics–White LED Backlight Driver Section

Load Characteristics
($V_{IN} = 3.7V$; 1.5X Mode; 15mA Load)

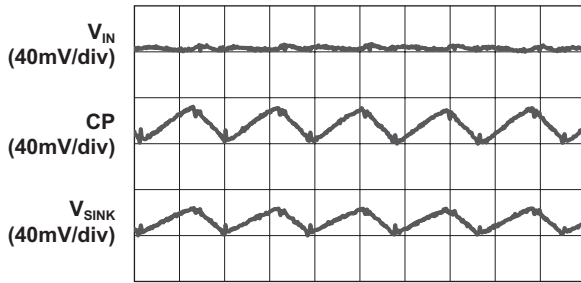

500ns/div

Load Characteristics
($V_{IN} = 2.7V$; 2X Mode; 15mA Load)

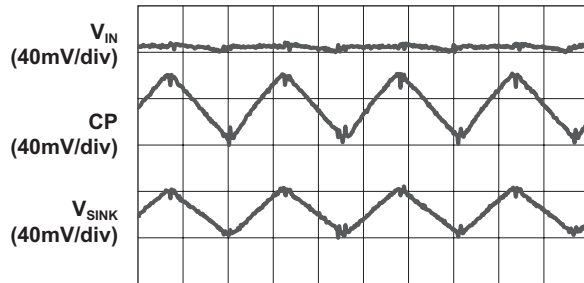

500ns/div

Load Characteristics
($V_{IN} = 3.9V$; 1.5X Mode; 20mA Load)

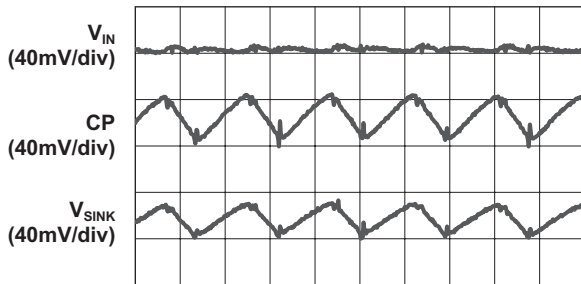

500ns/div

Load Characteristics
($V_{IN} = 2.9V$; 2X Mode; 20mA Load)

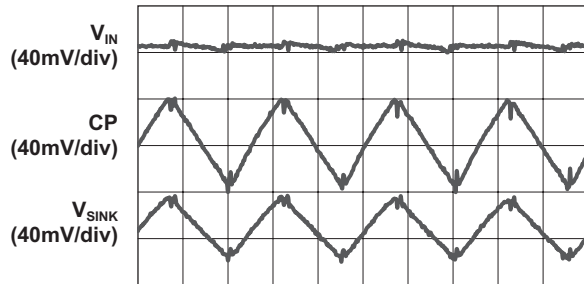

500ns/div

Load Characteristics
($V_{IN} = 4.2V$; 1.5X Mode; 30mA Load)

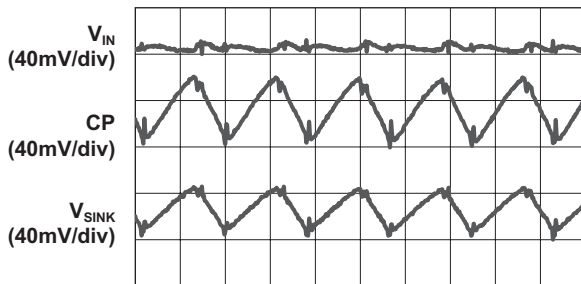

500ns/div

Load Characteristics
($V_{IN} = 3.2V$; 2X Mode; 30mA Load)

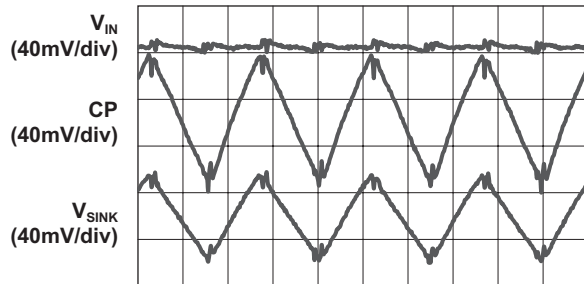

500ns/div

Typical Characteristics—White LED Backlight Driver Section

EN/SET Latch Timeout vs. Input Voltage

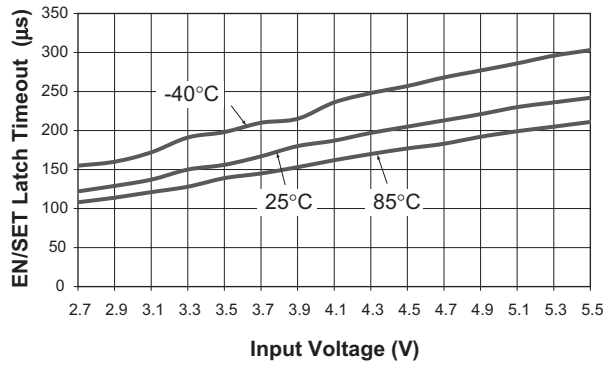

EN/SET Off Timeout vs. Input Voltage

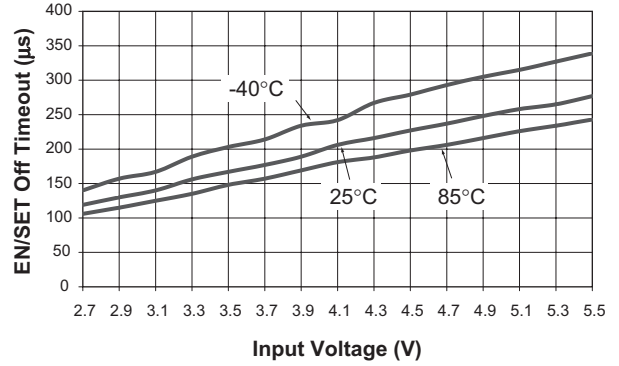

Input Ripple vs. Input Voltage

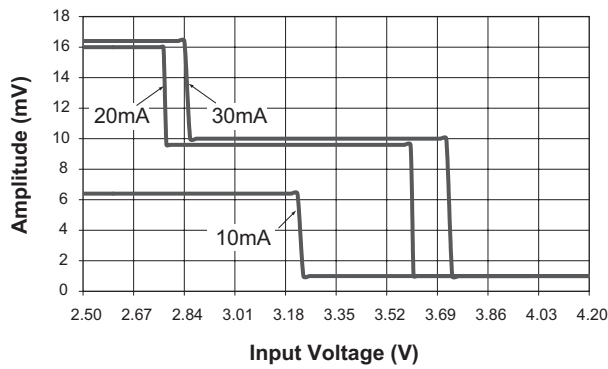

Enable Threshold High vs. Input Voltage

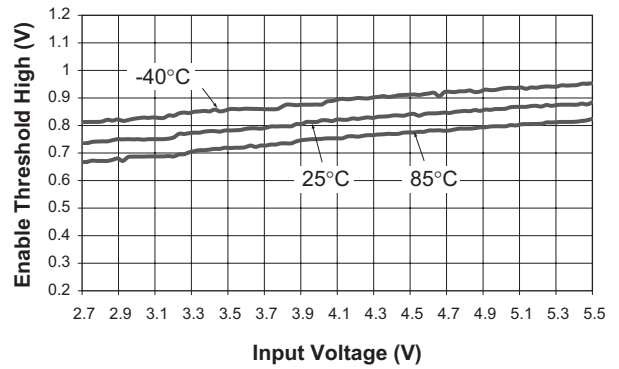

Enable Threshold Low vs. Input Voltage

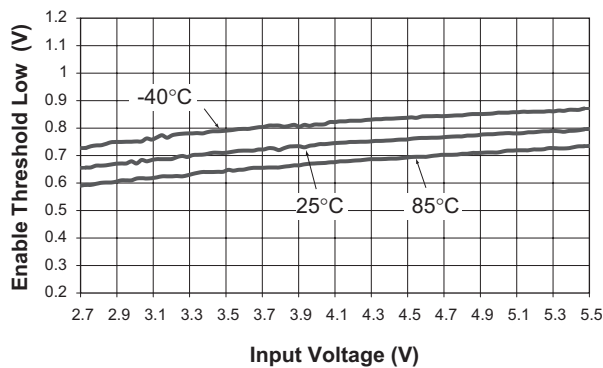

Functional Block Diagram

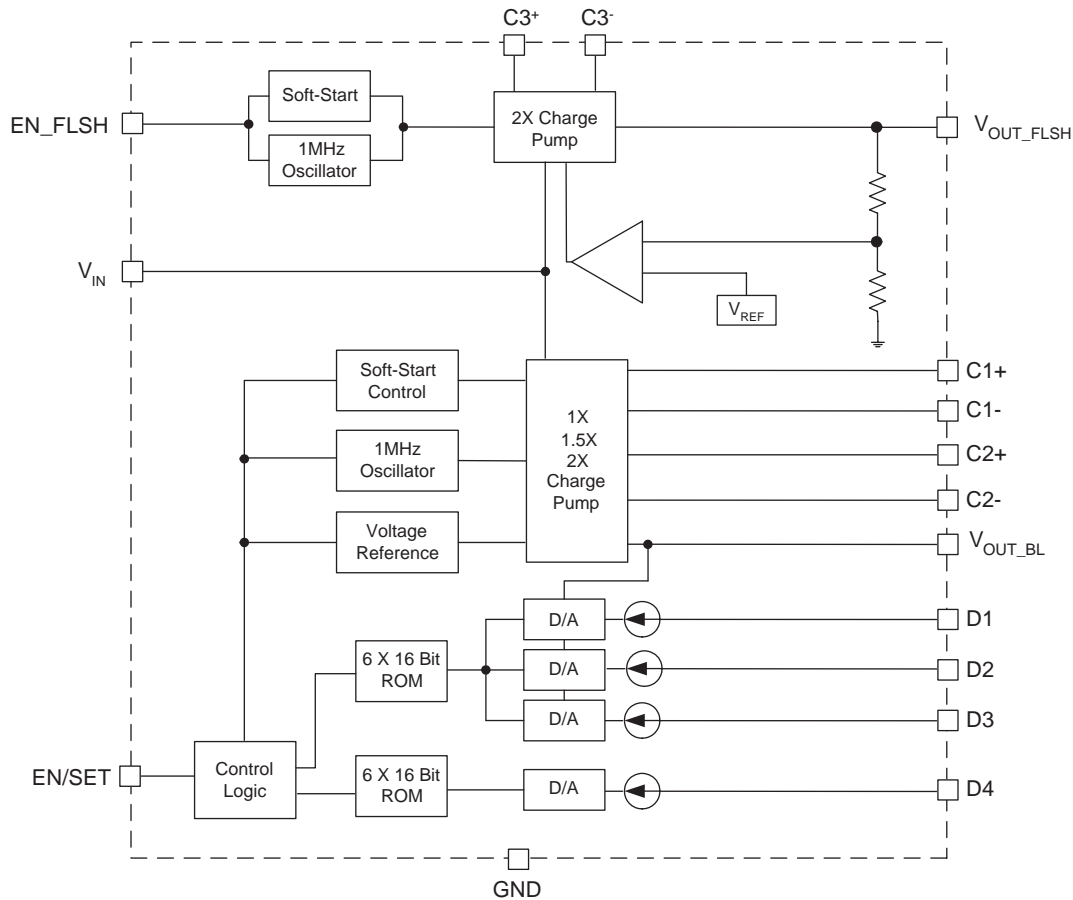

Functional Description

The AAT2805 is a dual charge pump designed for flash and white LED applications. The backlight charge pump is a tri-mode load switch (1X) and high efficiency (1.5X or 2X) charge pump device. To maximize power conversion efficiency, an internal sensing circuit monitors the voltage required on each constant current sink input and sets the load switch and charge pump modes based on the input battery voltage and the current sink input voltage. As the battery voltage discharges over time, the white LED charge pump is enabled when any of the four current sink inputs near dropout. The charge pump initially starts in 1.5X mode. If the charge pump output drops

enough for any current source output to become close to dropout, the charge pump will automatically transition to 2X mode. The four constant current sink inputs D1 to D4 can drive four individual LEDs with a maximum current of 30mA per LED. The unused sink inputs must be connected to V_{OUT_BL} ; otherwise, the part will operate only in 2X charge pump mode. The AS²Cwire serial interface enables and sets the constant current sink magnitudes. AS²Cwire addressing allows the LED main channels D1-D3 to be controlled independently from the LED sub-channel D4. The flash charge pump is a charge pump doubler with regulated output voltage. It is designed to deliver 120mA of continuous current and 250mA of pulsed current.

The AAT2805 requires six external components: three 1μF ceramic capacitors for the charge pump flying capacitors (C1, C2 and C3), one 1μF ceramic input capacitor (C_{IN}), one 0.33μF to 1μF ceramic capacitor for backlight charge pump output capacitor (C_{OUT}), and one 1μF ceramic capacitor for flash charge pump output capacitor (C_{OUT}).

Constant Current Output Level Settings

The constant current level for the LED channels is set via the AS²Cwire serial interface according to a logarithmic scale. The current level spacing is 1dB between adjacent constant current settings. In this manner, LED brightness appears to change linearly when the settings are traversed. Because the inputs D1 to D4 are true independent constant current sinks, the voltage observed on any single given input will be determined by the difference between V_{OUT} and the actual forward voltage (V_F) of the LED being driven.

Since the constant current levels are programmable, no PWM (pulse width modulation) or additional control circuitry is needed to control LED brightness. This feature greatly reduces the burden on a microcontroller or system IC to manage LED or display brightness, allowing the user to "set it and forget it." With its high-speed serial interface (>1MHz data rate), the LED current drive can be changed successively to brighten or dim LEDs, in smooth transitions (e.g., to fade-out) or in abrupt steps, giving the user complete programmability and real-time control of LED brightness.

For each Max Current scale (see Table 1), there are 16 current level settings separated from one another by approximately 1dB. Code 1 is full-scale current and Code 15 is full-scale current attenuated by roughly 14dB. Code 16 is reserved as a "no current" setting. When programming the charge pump, it will default to the 20mA maximum scale.

The AAT2805 offers an additional Low Current mode with reduced quiescent current (see Table 2). This mode is especially useful for low-current applications where a continuous, low current state is maintained. The reduction in quiescent current significantly reduces the impact due to maintaining a continuous backlighting state.

Data	Max I _{OUT} (mA)		
	20mA	30mA	15mA
1	20.0	30.0	15.0
2	17.8	26.7	13.3
3	15.9	23.8	11.9
4	14.3	21.4	10.7
5	12.7	19.0	9.5
6	11.1	16.7	8.3
7	10.2	15.2	7.6
8	8.9	13.3	6.7
9	7.9	11.9	6.0
10	7.0	10.5	5.2
11	6.3	9.5	4.8
12	5.7	8.6	4.3
13	5.1	7.6	3.8
14	4.4	6.7	3.3
15	4.1	6.2	3.1
16	0.0	0.0	0.0

Table 1: Constant Current Programming Levels.

Data	D1-D3 (mA)	D4 (mA)
1	0	0
2	0	0
3	0	0
4	0	0
5	0	0.05
6	0	0.5
7	0	1
8	0	2
9	0.05	0
10	0.5	0
11	1	0
12	2	0
13	0.05	0.05
14	0.5	0.5
15	1	1
16	2	2

Table 2: Low Current Register Settings.

AS²Cwire Serial Interface

The AS²Cwire single wire interface is used to set the possible combinations of current levels and LED channel states. AS²Cwire has addressing capability for multiple data registers. With multiple data registers, the main and sub-channel can be programmed together or independently from one another. AS²Cwire relies on the number of rising edges of the EN/SET pin to address and load the registers. AS²Cwire latches data or address after the EN/SET pin has been held high for time T_{LAT} . Address or data is differentiated by the number of EN/SET rising edges. Since the data registers are 4 bits each, the differentiating number of pulses is 2^4 or 16, so that Address 1 is signified by 17 rising edges, Address 2 by 18 rising edges, and so forth. Data is set to any number of rising edges between 1 and including 16. A typical write protocol is a burst of EN/SET rising edges, signifying a particular address, followed by a pause with EN/SET held high for the T_{LAT} timeout period, a burst of rising edges signifying data, and a T_{LAT} timeout for the data registers. Once an address is set, then multiple writes to the corresponding data register are allowed.

When EN/SET is held low for an amount of time greater than T_{OFF} , the charge pump enters into shutdown mode and draws less than $1\mu A$ from the supply. Address 1 is the default address on the first rising edge after the charge pump has been disabled. Whenever shutdown mode is entered, all registers are reset to 1.

AS²Cwire Addressing

Five addresses are available to enable all of the part's functionality (see Table 3). Two 4-bit registers control the main and sub-channel, giving 16 settings for each. The main and sub-channel are programmed to the same constant current level by using Address 1. Use Addresses 2 and 3 to program the main and sub-channel independently. Use Address 4 to program the Max Current register, which sets the Max Current scale. Lastly, Address 5 programs the Low Current register. The Low Current register controls the efficient Low Current mode.

When the Max Current register is programmed to 1, 2, or 3, changing the data for Addresses 1-3 will result in the corresponding values found in Table 1. When the Max Current register is programmed to 4,

the part is programmed to operate in Low Current mode and the Data for Addresses 1-3 is irrelevant. In Low Current mode, the Low Current register takes precedence. See the Low Current Register Settings table below for the current level settings and main/sub-configurations that result.

Address	EN/SET Edges	Addressed Register
1	17	1&2: D1-D4 Current
2	18	1: D1-D3 Current
3	19	2: D4 Current
4	20	3: Max Current
5	21	4: Low Current

Table 3: Address Settings.

Max Current and Low Current Registers

Use the Max Current and Low Current registers to program constant current settings outside of the 20mA Max scale. By default (without changing the Max Current register), the charge pump operates in the 20mA Max scale (see Table 1). For example, to change to the 30mA Max scale, address the Max Current register with 20 rising edges and pause for T_{LAT} . Program the Max Current register with 2 rising edges and pause for T_{LAT} . The part will next operate in the same Data row, but for the setting found in the 30mA Max column. Next, to change to a different setting on the 30mA Max scale, address the D1-D4 register with 17 rising edges. Program the new constant current level with 1-16 rising edges. The part will update to the new Data setting as shown in Table 1.

The charge pump has a distinct Low Current mode with ultra-low quiescent current. For drive currents of 2mA or less, the part operates with significantly reduced quiescent current. This is particularly useful for applications requiring an "always on" condition such as transmissive displays. For another example, to change to Low Current mode, address the Max Current register with 20 rising edges and pause for T_{LAT} . Program the Max Current register with 4 rising edges and pause for T_{LAT} . Address the Low Current register with 21 rising edges and pause for T_{LAT} . Program the Low Current register with 1-16 rising edges. The part will update to the new Low Current mode setting and operate with significantly reduced quiescent current.

AS²Cwire Serial Interface Timing Diagram

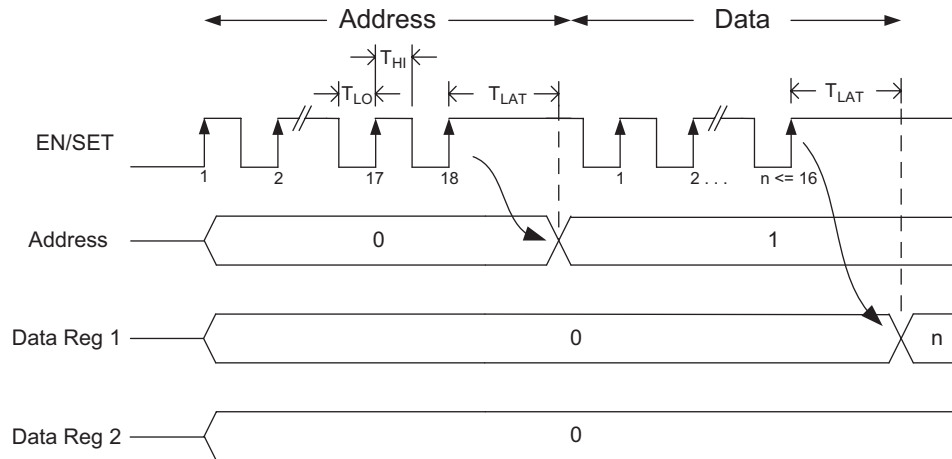

Data	Max Current
1	20mA Max scale
2	30mA Max scale
3	15mA Max scale
4	Low Current Mode

Table 4: Maximum Current Settings Address 4.

Disabled Current Sinks

The backlight charge pump is equipped with an "auto-disable" feature to protect against an LED failure condition. Current sink inputs that are not used should be disabled. To disable and properly terminate unused current sink inputs, they must be tied to V_{OUT} . If left unconnected or terminated to ground, the part will be forced to operate in 2X charge pump mode.

Properly terminating unused current sink inputs is important to prevent the charge pump modes from activating prematurely. When properly terminated, only a small sense current flows for each disabled channel. The sense current for each disabled channel is less than $10\mu A$.

Applications Information

LED Selection

The AAT2805 is specifically intended for driving white LEDs. However, the device design will allow the AAT2805 to drive most types of LEDs with forward voltage specifications ranging from 2.0V to 4.3V. LED applications may include main display backlighting, camera photo-flash applications, color (RGB) LEDs, infrared (IR) diodes for remotes, and other loads benefiting from a controlled output current generated from a varying input voltage. Since the D1 to D4 input current sinks are matched with negligible voltage dependence, the LED brightness will be matched regardless of the specific LED forward voltage (V_F) levels.

In some instances (e.g., in high-luminous-output applications such as photo-flash), it may be necessary to drive high- V_F type LEDs. The low-dropout current-sinks in the AAT2805 make it capable of driving LEDs with forward voltages as high as 4.3V at full current from an input supply as low as 3.0V. Outputs can be paralleled to drive high-current LEDs without complication.

Device Switching Noise Performance

The AAT2805 operates at a fixed frequency of approximately 1MHz to control noise and limit harmonics that can interfere with the RF operation of cellular telephone handsets or other communication devices. Back-injected noise appearing on the input pin of the charge pump is 20mV peak-to-peak, typically ten times less than inductor-based DC/DC boost converter white LED backlight solutions. The AAT2805 soft-start feature prevents noise transient effects associated with in-rush currents during start up of the charge pump circuit.

Capacitor Selection

Careful selection of the six external capacitors C_{IN} , C1, C2, C3 and C_{OUT} (for backlight and flash) is important because they will affect turn-on time, output ripple, and transient performance. Optimum performance will be obtained when low equivalent series resistance (ESR) (<100m Ω) ceramic capacitors are used. In general, low ESR may be defined as less than 100m Ω . A value of 1 μ F for all six capacitors is a good starting point when choosing capacitors.

Capacitor Characteristics

Ceramic composition capacitors are highly recommended over all other types of capacitors for use with the AAT2805. Ceramic capacitors offer many advantages over their tantalum and aluminum electrolytic counterparts. A ceramic capacitor typically has very low ESR, is lowest cost, has a smaller PCB footprint, and is non-polarized. Low ESR ceramic capacitors help maximize charge pump transient response. Since ceramic capacitors are non-polarized, they are not prone to incorrect connection damage.

Equivalent Series Resistance

ESR is an important characteristic to consider when selecting a capacitor. ESR is a resistance internal to a capacitor, which is caused by the leads, internal connections, size or area, material composition, and ambient temperature. Capacitor ESR is typically measured in milliohms for ceramic capacitors and can range to more than several ohms for tantalum or aluminum electrolytic capacitors.

Ceramic Capacitor Materials

Ceramic capacitors less than 0.1 μ F are typically made from NPO or COG materials. NPO and COG materials typically have tight tolerance and are stable over temperature. Larger capacitor values are typically composed of X7R, X5R, Z5U, or Y5V dielectric materials. Large ceramic capacitors, typically greater than 2.2 μ F, are often available in low-cost Y5V and Z5U dielectrics, but capacitors greater than 1 μ F are typically not required for AAT2805 applications.

Capacitor area is another contributor to ESR. Capacitors that are physically large will have a lower ESR when compared to an equivalent material smaller capacitor. These larger devices can improve circuit transient response when compared to an equal value capacitor in a smaller package size.

Thermal Protection

The AAT2805 has a thermal protection circuit that will shut down the two charge pumps if the die temperature rises above the thermal limit.

Charge Pump Power Efficiency

Backlight Charge Pump: The charge pump efficiency discussion in the following sections only accounts for the efficiency of the charge pump section itself. Due to the unique circuit architecture, it is very difficult to measure efficiency in terms of a percent value comparing input power over output power. Since the outputs are pure constant current sinks and typically drive individual loads, it is difficult to measure the output voltage for a given output (D1 to D4) to derive an overall output power measurement. For any given application, white LED forward voltage levels can differ, yet the output drive current will be maintained as a constant.

This makes quantifying output power a difficult task when taken in the context of comparing to other white LED driver circuit topologies. A better way to quantify total device efficiency is to observe the total input power to the device for a given LED current drive level. The best white LED driver for a given application should be based on trade-offs of size, external component count, reliability, operating range, and total energy usage...*not just "% efficiency."*

Efficiency of the AAT2805 may be quantified under very specific conditions and is dependent upon the input voltage versus the output voltage seen across the loads applied to outputs D1 through D4 for a given constant current setting. Depending on the combination of V_{IN} and voltages sensed at the current sinks, the device will operate in load switch mode. When any one of the voltages sensed at the current sinks nears dropout, the device will operate in 1.5X or 2X charge pump mode. Each of these modes will yield different efficiency values. Refer to the following two sections for explanations for each operational mode.

Load Switch Mode Efficiency: The load switch mode is operational at all times and functions alone to enhance device power conversion efficiency when V_{IN} is greater than the voltage across the load. When in load switch mode, the voltage conversion efficiency is defined as output power divided by input power:

$$\eta = \frac{P_{OUT}}{P_{IN}}$$

The expression to define the ideal efficiency (η) can be rewritten as:

$$\eta = \frac{P_{OUT}}{P_{IN}} = \frac{V_{OUT} \times I_{OUT}}{V_{IN} \times I_{OUT}} = \frac{V_{OUT}}{V_{IN}}$$

-or-

$$\eta(\%) = 100 \left(\frac{V_{OUT}}{V_{IN}} \right)$$

Charge Pump Mode Efficiency: Fractional charge pumps will boost the input supply voltage in the event where V_{IN} is less than the voltage required on the constant current source outputs. The efficiency (η) can be simply defined as a linear voltage regulator with an effective output voltage that is equal to one and a half or two times the input voltage. Efficiency (η) for an ideal 1.5X charge pump can typically be expressed as the output power divided by the input power:

$$\eta = \frac{P_{OUT}}{P_{IN}}$$

In addition, with an ideal 1.5X charge pump, the output current may be expressed as 2/3 of the input current. The expression to define the ideal efficiency (η) can be rewritten as:

$$\eta = \frac{P_{OUT}}{P_{IN}} = \frac{V_{OUT} \times I_{OUT}}{V_{IN} \times 1.5I_{OUT}} = \frac{V_{OUT}}{1.5V_{IN}}$$

-or-

$$\eta(\%) = 100 \left(\frac{V_{OUT}}{1.5V_{IN}} \right)$$

For a charge pump with an output of 5 volts and a nominal input of 3.5 volts, the theoretical efficiency is 95%. Due to internal switching losses and IC quiescent current consumption, the actual efficiency can be measured at 93%. These figures are in close agreement for output load conditions from 1mA to 100mA. Efficiency will decrease as load current drops below 0.05mA or when level of V_{IN} approaches V_{OUT} .

Flash Charge Pump: The flash charge pump is a regulated output voltage doubling charge pump. The efficiency is defined as a linear voltage regulator with an effective output voltage that is equal to two times the input voltage. The expression to define the ideal efficiency can be written as:

$$\eta = \frac{P_{OUT}}{P_{IN}} = \frac{V_{OUT} \times I_{OUT}}{V_{IN} \times 2.0I_{OUT}} = \frac{V_{OUT}}{2.0V_{IN}}$$

-or-

$$\eta(\%) = 100 \left(\frac{V_{OUT}}{2.0V_{IN}} \right)$$

For a charge pump with an output of 5 volts and a nominal input of 3.0 volts, the theoretical efficiency is 83.3%. Due to internal switching losses and IC quiescent current consumption, the actual efficiency can be measured at approximately 82%. Efficiency will decrease as the level of V_{IN} approaches that of the regulated V_{OUT} . Refer to the device typical characteristics curves for expected actual efficiency based on either input voltage or load current.

Ordering Information

Package	Marking ¹	Part Number (Tape and Reel) ²
TDFN44-16	NIXYY	AAT2805IXN-4.5-T1

Package Information

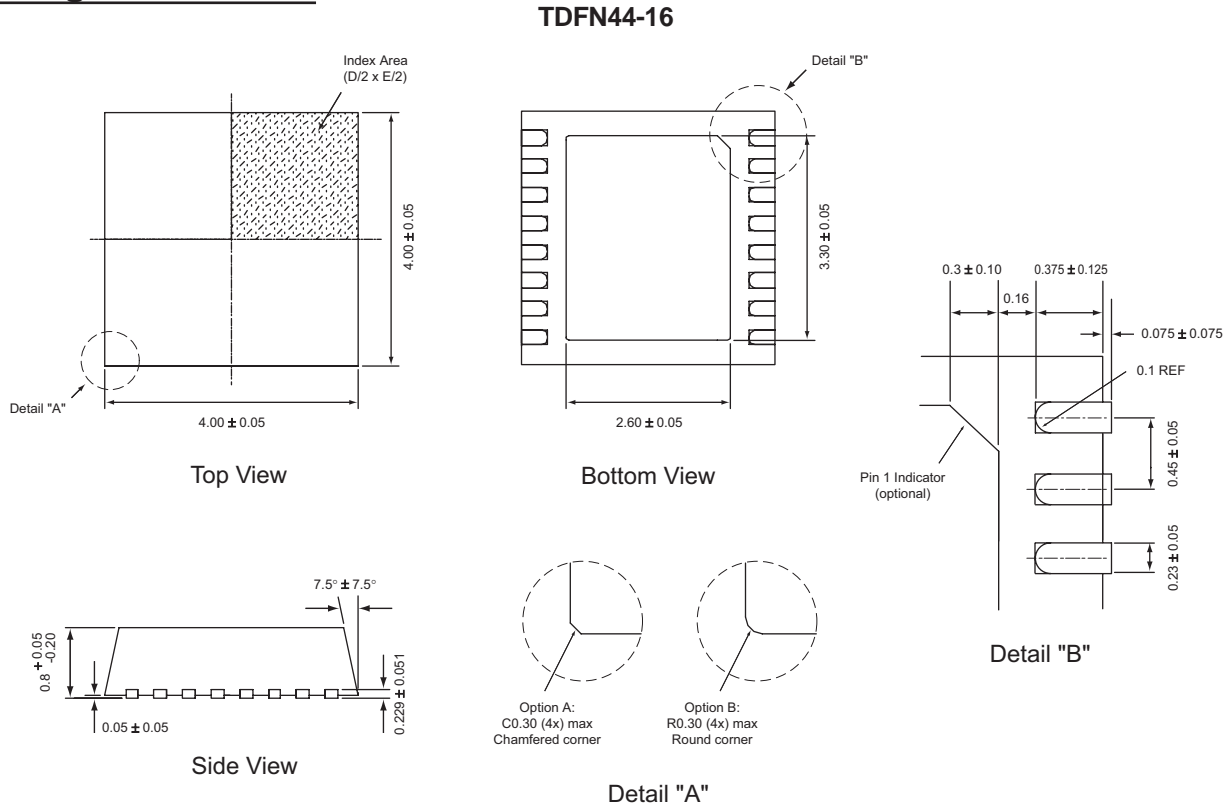

All dimensions in millimeters.

1. XYY = assembly and date code.
2. Sample stock is generally held on part numbers listed in **BOLD**.

AnalogicTech cannot assume responsibility for use of any circuitry other than circuitry entirely embodied in an AnalogicTech product. No circuit patent licenses, copyrights, mask work rights, or other intellectual property rights are implied.

AnalogicTech reserves the right to make changes to their products or specifications or to discontinue any product or service without notice, and advise customers to obtain the latest version of relevant information to verify, before placing orders, that information being relied on is current and complete. All products are sold subject to the terms and conditions of sale supplied at the time of order acknowledgement, including those pertaining to warranty, patent infringement, and limitation of liability.

AnalogicTech warrants performance of its semiconductor products to the specifications applicable at the time of sale in accordance with AnalogicTech's standard warranty. Testing and other quality control techniques are utilized to the extent AnalogicTech deems necessary to support this warranty. Specific testing of all parameters of each device is not necessarily performed.

Advanced Analogic Technologies, Inc.
 830 E. Arques Avenue, Sunnyvale, CA 94085
 Phone (408) 737-4600
 Fax (408) 737-4611

