

OH023

GaAs hall element

Magnetic sensor

■ Features

- Hall voltage : typ. 90mV($V_C=3V, B=0.1T$)
- Input resistance : typ. 2k Ω (min. 1.5k Ω)
- Output resistance : typ. 7k Ω (max. 10k Ω)
- Sealed in the Mini type (4-pin) package. Automatic insertion through taping and magazine.

■ Applications

- Various hall motor
(Applicable to CD, VD, VCR, FDD, and other portable equipment)
- Applicable to wide-varying field (OA equipment, etc.)

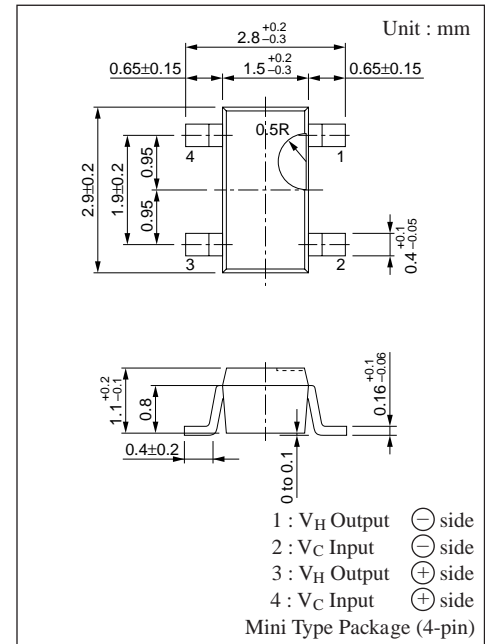

Marking Symbol : OT

■ Absolute Maximum Ratings ($T_a=25^\circ C$)

Parameter	Symbol	Rating	Unit
Control voltage	V_C	6	V
Power dissipation	P_D	150	mW
Operating ambient temperature	T_{opr}	-10 to +125	$^\circ C$
Storage temperature	T_{stg}	-55 to +125	$^\circ C$

■ Electrical Characteristics ($T_a=25^\circ C$)

Parameter	Symbol	Condition	min	typ	max	Unit
Hall voltage	V_H^{*1}	$V_C=3V, B=0.1T$	70	90	110	mV
Unbalance voltage	V_{HO}	$V_C=3V, B=0T$			± 9.5	mV
Input Resistance	R_{IN}	$I_C=0.1mA, B=0T$	1.5	2	3	k Ω
Output resistance	R_{OUT}	$I_C=0.1mA, B=0T$	5	7	10	k Ω
Temperature coefficient of hall voltage	β	$I_C=1.5mA, B=0.1T$			-0.06	%/ $^\circ C$
Temperature coefficient of input resistance	α	$I_C=0.1mA, B=0T$			0.3	%/ $^\circ C$
Linearity of hall voltage	γ^{*2}	$I_C=1mA, B=0.05T/0.1T$			2	%

$$*1 V_H = \frac{|V_H^+| + |V_H^-|}{2}$$

*2 The linearity γ of V_H is a percentage of the cumulative sensitivity of $K_{H0.05}$ and $K_{H0.1}$ measured at $B=0.05T$ and $0.1T$ for the average value.

$$\gamma = \frac{K_{H0.1} - K_{H0.05}}{1/2 (K_{H0.05} + K_{H0.1})} \quad \left(\text{Percentage of the cumulative sensitivity } K_H = \frac{V_H}{I_C \cdot B} \right)$$

$P_D - T_a$

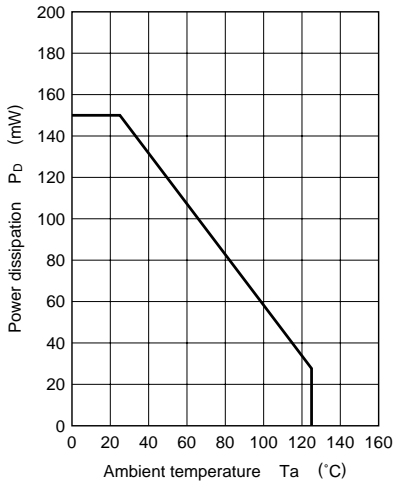

$V_H - T_a$

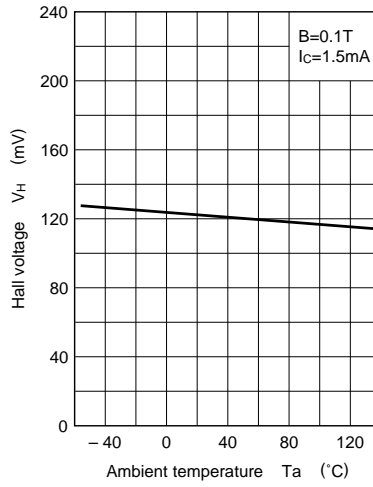

$R_{IN} - T_a$

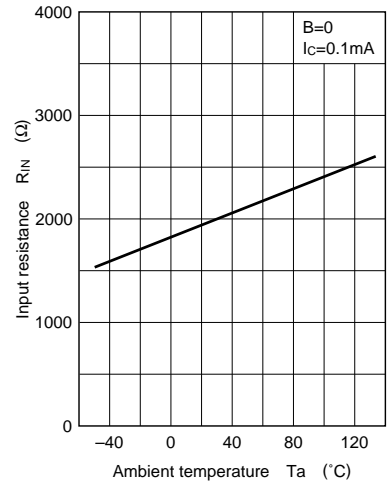

$V_H - B$

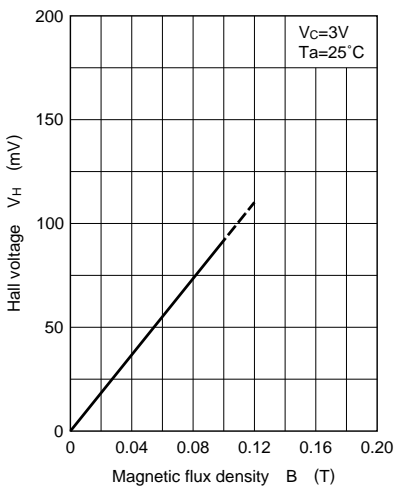

$V_H - I_c$

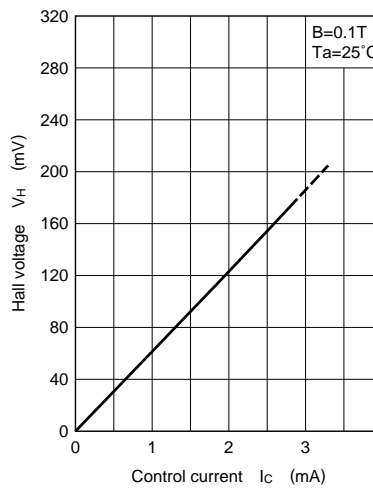

$V_H - V_c$

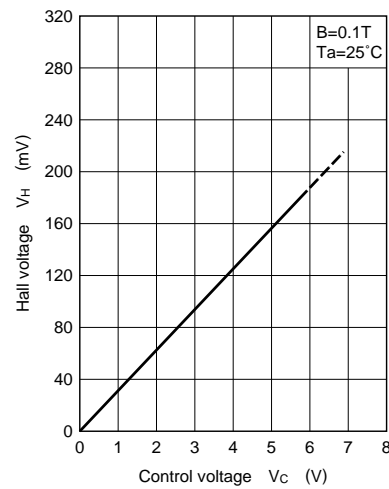

■ Typical Drive Circuit

