

### Mechanical Keypad with Sealed Construction for Automatic Soldering

- Available in two sizes:  
6 mm square and 12 mm square
- Snap-action contact mechanism assures short key stroking and a sharp click to confirm input
- Ground terminal available to protect against static electricity
- Ideal for applications such as audio, office and communications equipment, measuring instruments, industrial robots, VCRs, TVs, and vending machines
- Stick (magazine) packaging style available: contact OMRON for details
- Sealed for CFC (Freon) cleaning

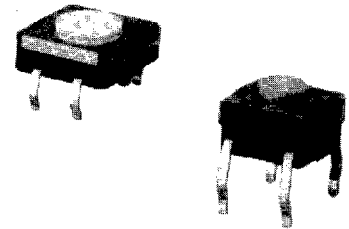

### Ordering Information

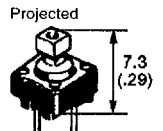
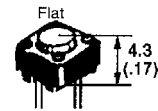

Type	Plunger	Switch height x pitch	Operating Force	Part Number			
				Without ground terminal		With ground terminal	
				Bags	Sticks*	Bags	Sticks*
SPST-NO	Flat	6 x 6 mm	General-purpose: 160 g	<b>B3W-1000</b>	<b>B3W-1000S</b>	<b>B3W-1100</b>	<b>B3W-1100S</b>
			High-force: 230 g	<b>B3W-1002</b>	<b>B3W-1002S</b>	<b>B3W-1102</b>	<b>B3W-1102S</b>
	Projected	6 x 6 mm	General-purpose: 160 g	<b>B3W-1050</b>	<b>B3W-1050S</b>	<b>B3W-1150</b>	<b>B3W-1150S</b>
			High-force: 230 g	<b>B3W-1052</b>	<b>B3W-1052S</b>	<b>B3W-1152</b>	<b>B3W-1152S</b>
	Flat	12 x 12 mm	General-purpose: 200 g	<b>B3W-4000</b>	<b>B3W-4000S</b>	<b>B3W-4100</b>	<b>B3W-4100S</b>
			High-force: 350 g	<b>B3W-4005</b>	<b>B3W-4005S</b>	<b>B3W-4105</b>	<b>B3W-4105S</b>
	Projected	12 x 12 mm	General-purpose: 200 g	<b>B3W-4050</b>	<b>B3W-4050S</b>	<b>B3W-4150</b>	<b>B3W-4150S</b>
			High-force: 350 g	<b>B3W-4055</b>	<b>B3W-4055S</b>	<b>B3W-4155</b>	<b>B3W-4155S</b>

\* Number of switches per stick: **6 x 6 mm** Without ground terminal ... 80/stick  
 With ground terminal ..... 75/stick  
**12 x 12 mm** Without ground terminal ... 45/stick  
 With ground terminal ..... 40/stick

Note: Switches cannot be water-washed.

## ■ ACCESSORIES

### Keycaps

Keycap color	Applicable type:	Part Number		
		6 x 6 mm	12 x 12 mm	
	Size:	4 x 4 mm	9 x 9 mm	12 x 12 mm
Light gray		<b>B32-1000</b>	<b>B32-1200</b>	<b>B32-1300</b>
Black		<b>B32-1010</b>	<b>B32-1210</b>	<b>B32-1310</b>
Orange		<b>B32-1020</b>	<b>B32-1220</b>	<b>B32-1320</b>
Yellow		<b>B32-1030</b>	<b>B32-1230</b>	<b>B32-1330</b>
Blue		<b>B32-1040</b>	<b>B32-1240</b>	<b>B32-1340</b>
Green		<b>B32-1050</b>	<b>B32-1250</b>	<b>B32-1350</b>
White		<b>B32-1060</b>	<b>B32-1260</b>	<b>B32-1360</b>
Light green		<b>B32-1070</b>	<b>B32-1270</b>	<b>B32-1370</b>
Red		<b>B32-1080</b>	<b>B32-1280</b>	<b>B32-1380</b>

Note: Keycaps are available in different sizes and colors for exclusive use with the 6 x 6 mm and 12 x 12 mm projected plunger version of Model B3W.

### Plunger Identification Table

Use this table to determine keyswitch type by plunger color.

Plunger color	Operating force	Type
White	160 g	B3W-1000, 1050, 1100, 1150
White	200 g	B3W-4000, 4050, 4100, 4150
Yellow	230 g	B3W-1002, 1052, 1102, 1152
Yellow	350 g	B3W-4005, 4055, 4105, 4155

## ■ CONSTRUCTION

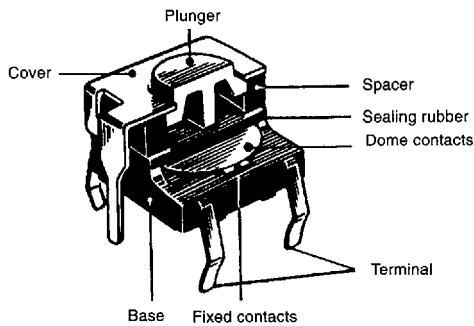

# Characteristics

Switching capacity		50 mA 24 VDC (resistive load)	
Permissible load		1 mA 5 VDC min. (resistive load)	
Contact resistance		100 MΩ max.	
Insulation resistance		100 MΩ min. (at 250 VDC)	
Dielectric strength		500 VAC, 50/60 Hz for 1 minute	
Bounce time		5 ms max.	
Vibration	Malfunction durability	10 to 55 Hz, 1.5 mm double amplitude	
Shock	Mechanical durability	1,000 m/s <sup>2</sup> (approx. 100 G)	
	Malfunction durability	100 m/s <sup>2</sup> (approx. 10 G)	
Ambient temperature	Operating	-25° to 70°C	
Humidity		35% to 85% RH	
Service life [mechanical/electrical]		B3W-1□□□	B3W-4□□□
	General-purpose type	1,000,000 operations min.	3,000,000 operations min.
	High-load type	300,000 operations min.	1,000,000 operations min.
Weight		B3W-1□□□	B3W-4□□□
		Approx. 0.30 g	Approx. 1.00 g

## CHARACTERISTIC DATA

Operating force vs. stroke  
(typical example)

B3W-1□□□ series

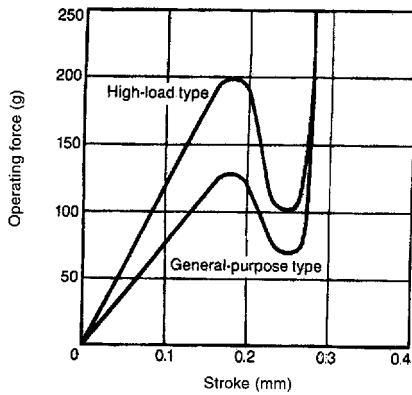

B3W-4□□□ series

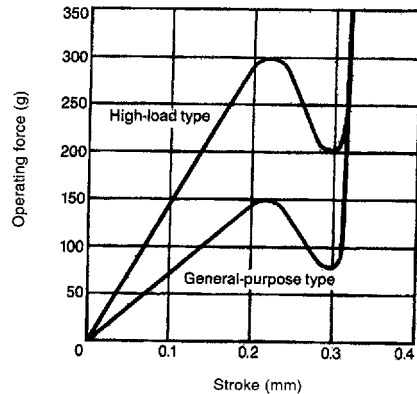

## OPERATING CHARACTERISTICS

	B3W-1□□□		B3W-4□□□	
	General-purpose	High-force	General-purpose	High-force
Operating force (OF) max.	160 g	230 g	200 g	350 g
Release force (RF) min.	20 g	50 g	30 g	50 g
Pretravel (PT)	0.25 <sup>+0.2</sup> / <sub>-0.1</sub> mm	0.25 <sup>+0.2</sup> / <sub>-0.1</sub> mm	0.3 <sup>+0.2</sup> / <sub>-0.1</sub> mm	0.3 <sup>+0.2</sup> / <sub>-0.1</sub> mm

# Dimensions

Unit: mm (inch)

## ■ 6 MM SQUARE TYPES

### B3W-1000, B3W-1002

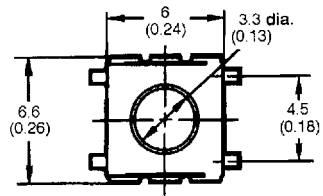

### B3W-1100, B3W-1102

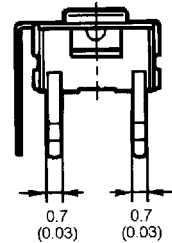
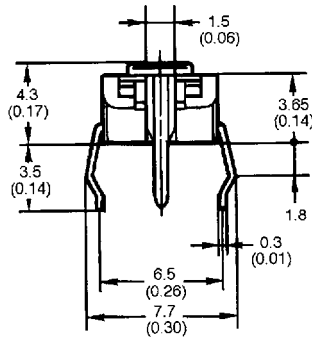
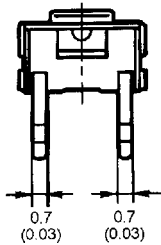
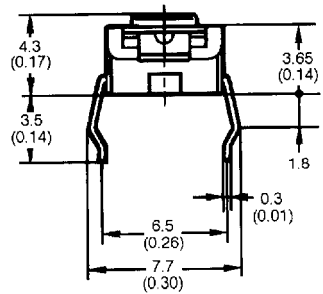
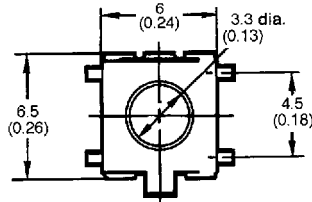

Mounting holes in PCB (top view)

Terminal arrangement/ Internal connection (top view)

Mounting holes in PCB (top view)

Terminal arrangement/ Internal connection (top view)

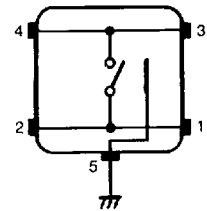
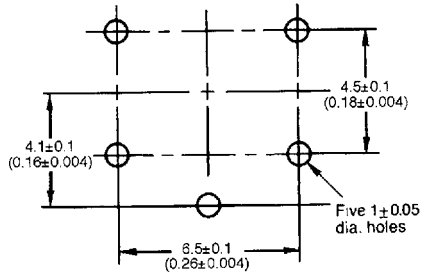
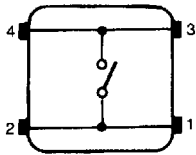
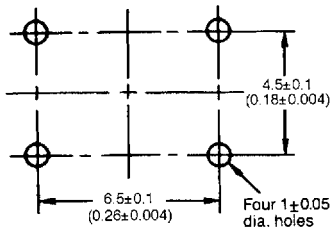

Note: Unless otherwise specified, a tolerance of  $\pm 0.2$  mm applies to all dimensions.

■ 6 MM SQUARE TYPES

B3W-1050, B3W-1052

B3W-1150, B3W-1152

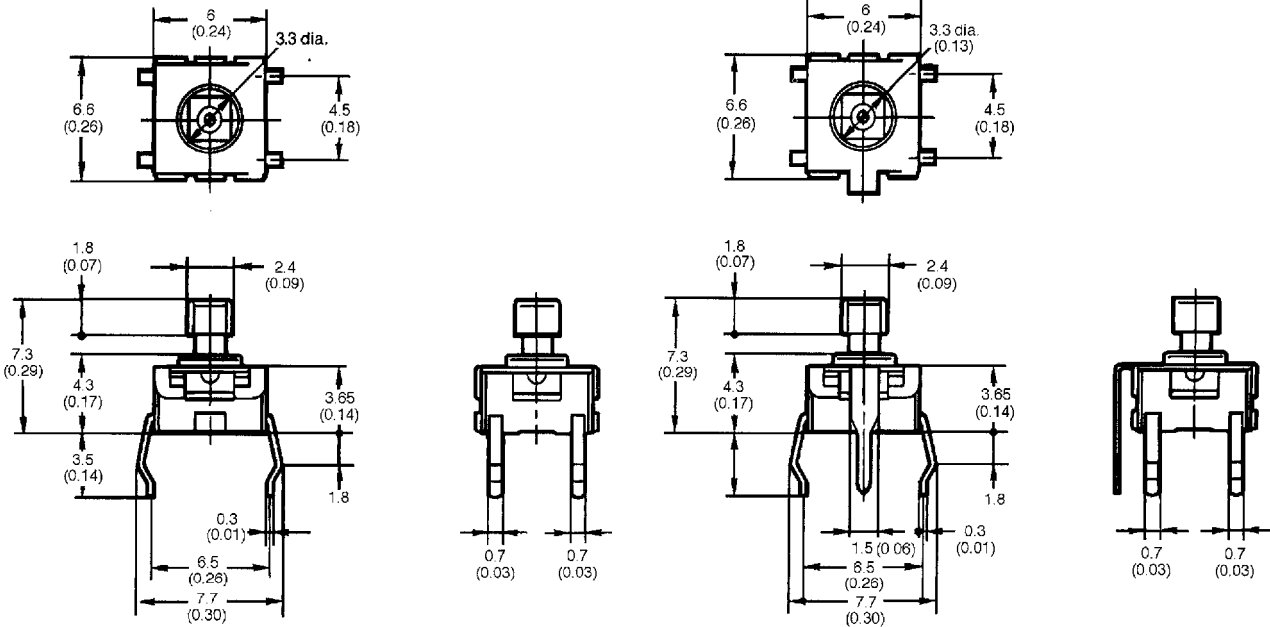

Mounting holes in PCB (top view)

Terminal arrangement/ Internal connection (top view)

Mounting holes in PCB (top view)

Terminal arrangement/ Internal connection (top view)

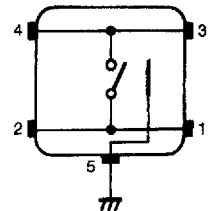
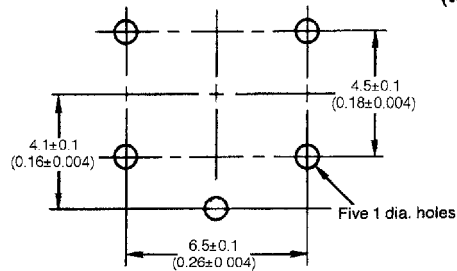
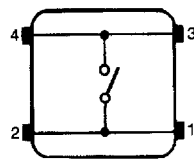
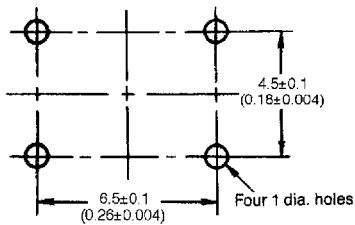

Note: Unless otherwise specified, a tolerance of  $\pm 0.2$  mm applies to all dimensions.

Unit: mm (inch)

■ 12 MM SQUARE TYPES

B3W-4000, B3W-4005

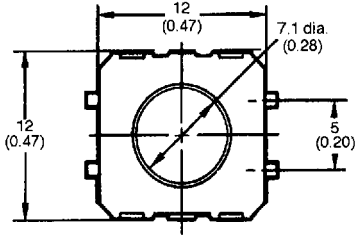

B3W-4100, B3W-4105

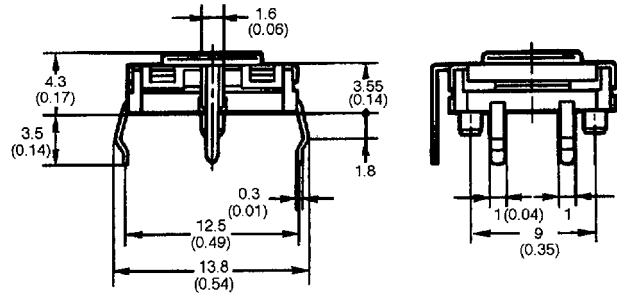
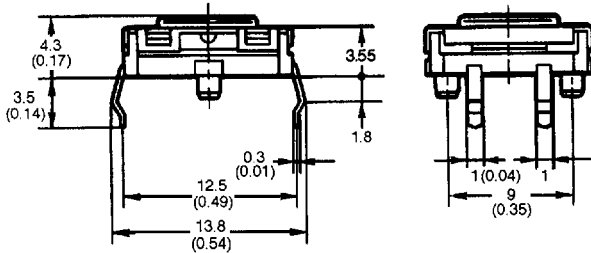
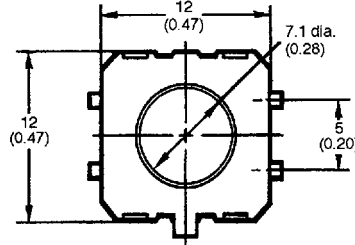

Mounting holes in PCB (top view)

Terminal arrangement/ Internal connection (top view)

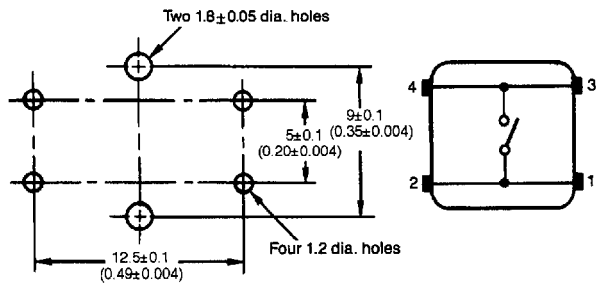

Mounting holes in PCB (top view)

Terminal arrangement/ Internal connection (top view)

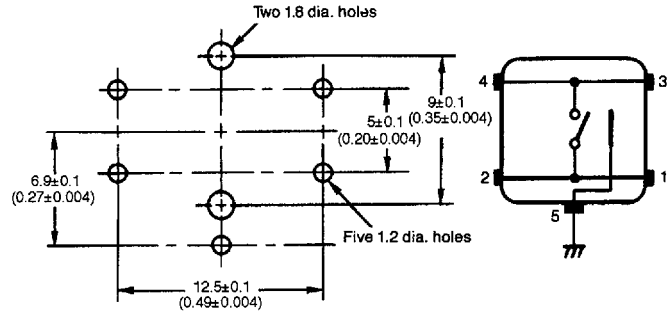

Note: Unless otherwise specified, a tolerance of ± 0.2 mm applies to all dimensions.

■ 12 MM SQUARE TYPES

B3W-4050, B3W-4055

B3W-4150, B3W-4155

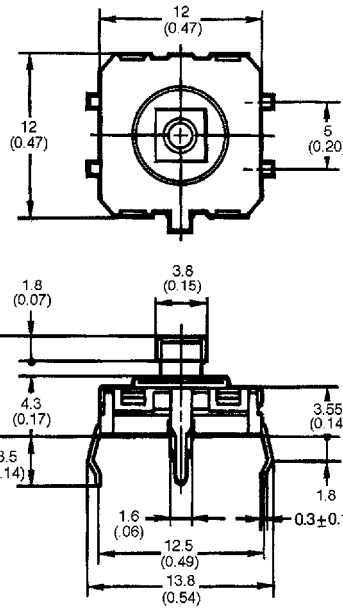
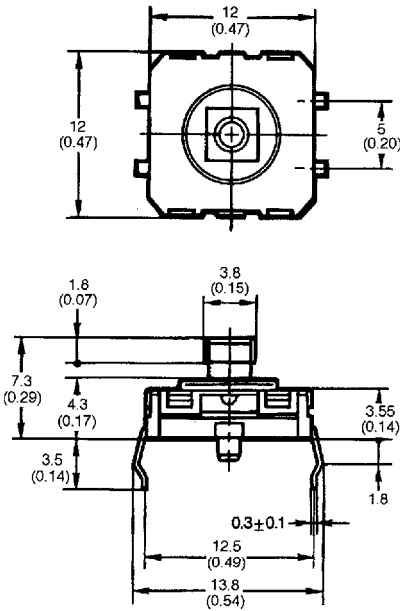

Mounting holes in PCB (top view)

Terminal arrangement/ Internal connection (top view)

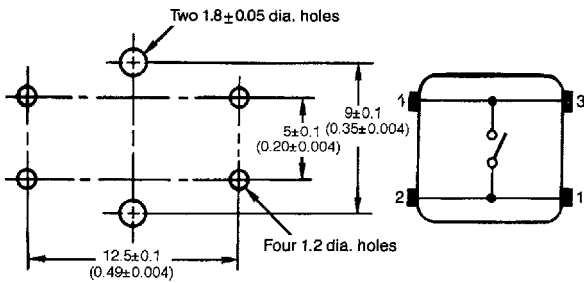

Mounting holes in PCB (top view)

Terminal arrangement/ Internal connection (top view)

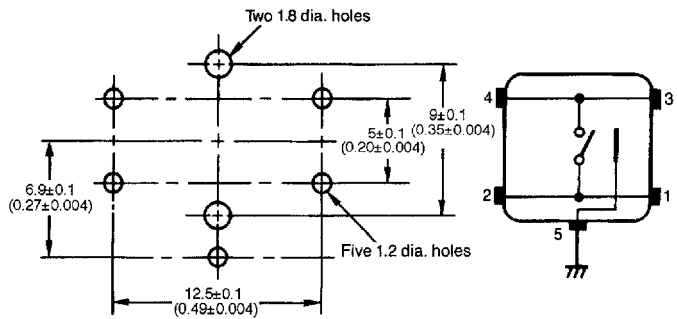

Note: Unless otherwise specified, a tolerance of  $\pm 0.2$  mm applies to all dimensions.

Unit: mm (inch)

■ KEYCAPS

B32-10 0

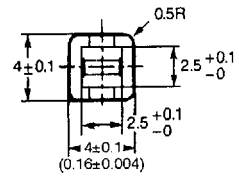
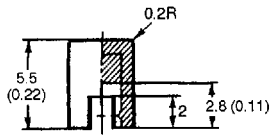

B32-12 0

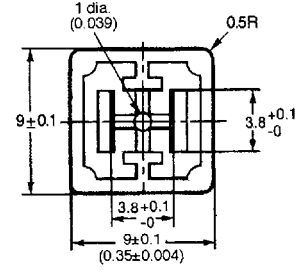
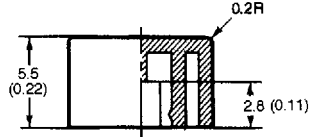

B32-13 0

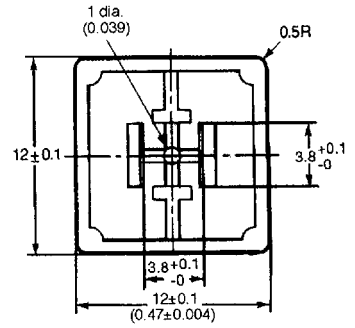
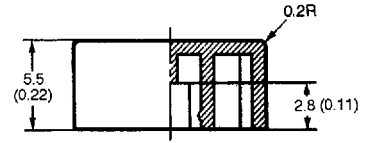

Note: Unless otherwise specified, a tolerance of ± 0.2 mm applies to all dimensions.