



8K x 8 Power-Switched and Reprogrammable PROM

Features

- CMOS for optimum speed/power
- Windowed for reprogrammability
- High speed
 - 20 ns (commercial)
 - 25 ns (military)
- Low power
 - 660 mW (commercial)
 - 770 mW (military)
- Super low standby power (7C261)
 - Less than 220 mW when deselected
 - Fast access: 20 ns
- EPROM technology 100% programmable
- Slim 300-mil or standard 600-mil packaging available
- $5V \pm 10\% V_{CC}$, commercial and military

- Capable of withstanding greater than 2001V static discharge
- TTL-compatible I/O
- Direct replacement for bipolar PROMs

Functional Description

The CY7C261, CY7C263, and CY7C264 are high-performance 8192-word by 8-bit CMOS PROMs. When deselected, the 7C261 automatically powers down into a low-power standby mode. It is packaged in a 300-mil-wide package. The 7C263 and 7C264 are packaged in 300-mil-wide and 600-mil-wide packages respectively, and do not power down when deselected. The reprogrammable packages are equipped with an erasure window; when exposed to UV light, these PROMs are erased and can then be reprogrammed. The memory cells utilize proven EPROM

floating-gate technology and byte-wide intelligent programming algorithms.

The CY7C261, CY7C263, and CY7C264 are plug-in replacements for bipolar devices and offer the advantages of lower power, superior performance and programming yield. The EPROM cell requires only 12.5V for the supervoltage and low current requirements allow for gang programming. The EPROM cells allow for each memory location to be tested 100%, as each location is written into, erased, and repeatedly exercised prior to encapsulation. Each PROM is also tested for AC performance to guarantee that after customer programming the product will meet DC and AC specification limits.

Read is accomplished by placing an active LOW signal on CS. The contents of the memory location addressed by the address line ($A_0 - A_{12}$) will become available on the output lines ($O_0 - O_7$).

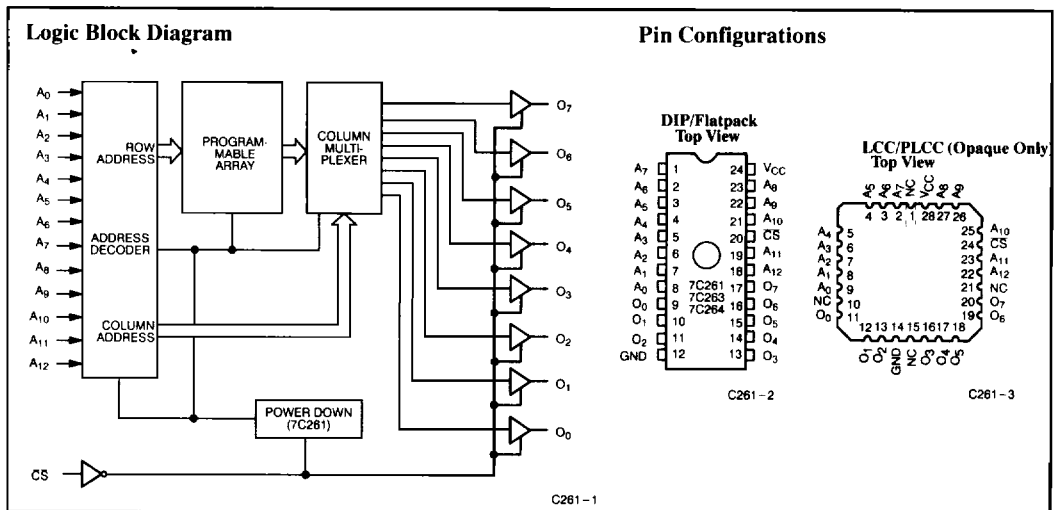

Selection Guide

		7C261-20 7C263-20 7C264-20	7C261-25 7C263-25 7C264-25	7C261-35 7C263-35 7C264-35	7C261-45 7C263-45 7C264-45	7C261-55 7C263-55 7C264-55
Maximum Access Time (ns)		20	25	35	45	55
Maximum Operating Current (mA)	Commercial	120	120	100	100	100
	Military		140	120	120	120
Maximum Standby Current (mA) (7C261 only)	Commercial	40	40	30	30	30
	Military		40	30	30	30

For an 8K x 8 Registered PROM, see the CY7C265.



Maximum Ratings

(Above which the useful life may be impaired. For user guidelines, not tested.)

Storage Temperature	-65°C to +150°C
Ambient Temperature with Power Applied	-55°C to +125°C
Supply Voltage to Ground Potential (Pin 24 to Pin 12)	-0.5V to +7.0V
DC Voltage Applied to Outputs in High Z State	-0.5V to +7.0V
DC Input Voltage	-3.0V to +7.0V
DC Program Voltage (Pin 19 DIP, Pin 23 LCC)	13.0V

Static Discharge Voltage	>2001V (per MIL-STD-883, Method 3015)
Latch-Up Current	>200 mA
UV Exposure	7258 Wsec/cm ²

Operating Range

Range	Ambient Temperature	V _{CC}
Commercial	0°C to +70°C	5V ± 10%
Industrial ^[1]	-40°C to +85°C	5V ± 10%
Military ^[2]	-55°C to +125°C	5V ± 10%

Electrical Characteristics Over the Operating Range^{3, 4}

Parameter	Description	Test Conditions	7C261-20, 25 7C263-20, 25 7C264-20, 25		7C261-35, 45, 55 7C263-35, 45, 55 7C264-35, 45, 55		Unit	
			Min.	Max.	Min.	Max.		
V _{OH}	Output HIGH Voltage	V _{CC} = Min., I _{OH} = -2.0 mA	2.4				V	
V _{OH}	Output HIGH Voltage	V _{CC} = Min., I _{OH} = -4.0 mA			2.4		V	
V _{OL}	Output LOW Voltage	V _{CC} = Min., I _{OL} = 8 mA (6 mA Mil)		0.4			V	
V _{OL}	Output LOW Voltage	V _{CC} = Min., I _{OL} = 16 mA				0.4	V	
V _{IH}	Input HIGH Level		2.0		2.0		V	
V _{IL}	Input LOW Level			0.8		0.8	V	
I _{IX}	Input Current	GND ≤ V _{IN} ≤ V _{CC}	-10	+10	-10	+10	µA	
V _{CD}	Input Diode Clamp Voltage		Note 4		Note 4			
I _{OZ}	Output Leakage Current	GND ≤ V _{OUT} ≤ V _{CC} Output Disabled	Com'l	-10	+10	-10	+10	µA
			Mil	-40	+40	-40	+40	
I _{OS}	Output Short Circuit Current ^[5]	V _{CC} = Max., V _{OUT} = GND	-20	-90	-20	-90	mA	
I _{CC}	Power Supply Current	V _{CC} = Max., f = Max., I _{OUT} = 0 mA	Com'l		120		100	mA
			Mil		140		120	
I _{SB}	Standby Supply Current (7C261)	V _{CC} = Max., CS ≥ V _{IH}	Com'l		40		30	mA
			Mil		40		30	
V _{PP}	Programming Supply Voltage		12	13	12	13	V	
I _{PP}	Programming Supply Current			50		50	mA	
V _{IHP}	Input HIGH Programming Voltage		4.75		4.75		V	
V _{ILP}	Input LOW Programming Voltage			0.4		0.4	V	

Capacitance^[4]

Parameter	Description	Test Conditions	Max.	Unit
C _{IN}	Input Capacitance	T _A = 25°C, f = 1 MHz, V _{CC} = 5.0V	10	pF
C _{OUT}	Output Capacitance		10	pF

Notes:

- See the Ordering Information section regarding industrial temperature range specification.
- T_A is the "instant on" case temperature.
- See the last page of this specification for Group A subgroup testing information.
- See the "Introduction to CMOS PROMs" section of the Cypress Data Book for general information on testing.
- For test purposes, not more than one output at a time should be shorted. Short circuit test duration should not exceed 30 seconds.

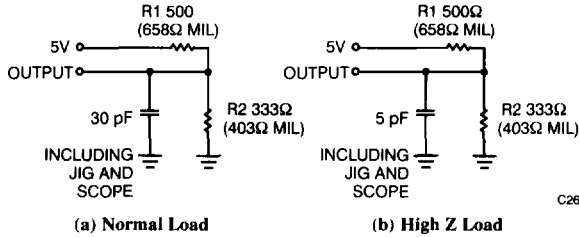
AC Test Loads and Waveforms^[4]
Test Load for -20 through -30 speeds

C261-4

C261-5

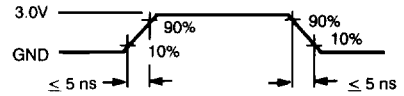

Equivalent to: THÉVENIN EQUIVALENT

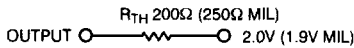
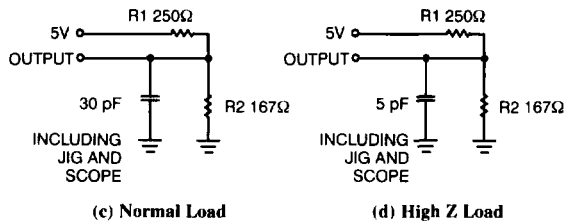

Test Load for -35 through -55 speeds

C261-6

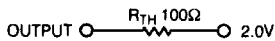
Equivalent to: THÉVENIN EQUIVALENT

Switching Characteristics Over the Operating Range^[2, 3, 4]

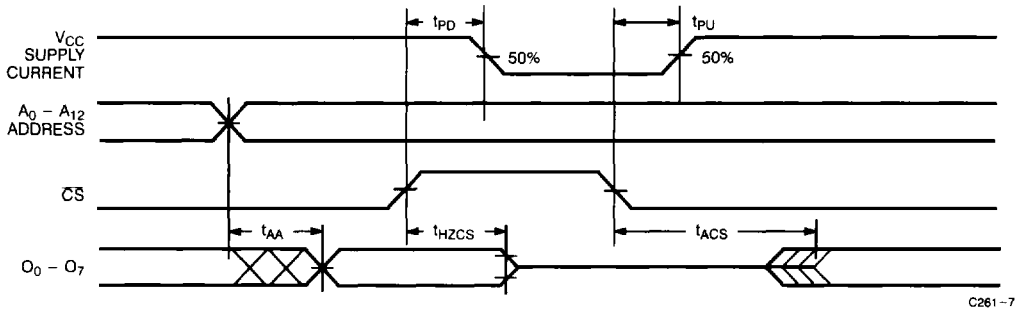
Parameter	Description	7C261-20		7C261-25		7C261-35		7C261-45		7C261-55		Unit
		7C263-20		7C263-25		7C263-35		7C263-45		7C263-55		
		Min.	Max.	Min.	Max.	Min.	Max.	Min.	Max.	Min.	Max.	
t _{AA}	Address to Output Valid		20		25		35		45		55	ns
t _{HZCS1}	Chip Select Inactive to High Z (7C263 and 7C264)		12		12		20		30		35	ns
t _{HZCS2}	Chip Select Inactive to High Z (7C261)		20		25		35		45		55	ns
t _{ACS1}	Chip Select Active to Output Valid (7C263 and 7C264)		12		12		20		30		35	ns
t _{ACS2}	Chip Select Active to Output Valid (7C261)		20		25		35		45		55	ns
t _{PU}	Chip Select Active to Power-Up (7C261)	0		0		0		0		0		ns
t _{PD}	Chip Select Inactive to Power-Down (7C261)		20		25		35		45		55	ns

Switching Waveforms^[4]

C261-7

Erase Characteristics

Wavelengths of light less than 4000 Å begin to erase the devices in the windowed package. For this reason, an opaque label should be placed over the window if the PROM is exposed to sunlight or fluorescent lighting for extended periods of time.

The recommended dose of ultraviolet light for erasure is a wavelength of 2537 Å for a minimum dose (UV intensity multiplied by exposure time) of 25 Wsec/cm². For an ultraviolet lamp with a 12 mW/cm² power rating, the exposure time would be approximately 35 minutes. The 7C261 or 7C263 needs to be within 1 inch of the lamp during erasure. Permanent damage may result if the PROM is exposed to high-intensity UV light for an extended period of time. 7258 Wsec/cm² is the recommended maximum dosage.

Operating Modes
Read

Read is the normal operating mode for a programmed device. In this mode, all signals are normal TTL levels. The PROM is addressed with a 13-bit field, a chip select, (active LOW), is applied to the CS pin, and the contents of the addressed location appear on the data out pins.

Program, Program Inhibit, Program Verify

These modes are entered by placing a high voltage V_{PP} on pin 19, with pins 18 and 20 set to V_{ILP} . In this state, pin 21 becomes a latch signal, allowing the upper 5 address bits to be latched into an onboard register, pin 22 becomes an active LOW program (PGM) signal and pin 23 becomes an active LOW verify (VFY) signal. Pins 22 and 23 should never be active LOW at the same time. The PROGRAM mode exists when PGM is LOW, and VFY is HIGH. The verify mode exists when the reverse is true, PGM HIGH and VFY LOW and the program inhibit mode is entered with both PGM and VFY HIGH. Program inhibit is specifically provided to allow data to be placed on and removed from the data pins without conflict.

Programming Information

Programming support is available from Cypress as well as from a number of third-party software vendors. For detailed programming information, including a listing of software packages, please see the PROM Programming Information located at the end of this section. Programming algorithms can be obtained from any Cypress representative.

Table 1. Mode Selection

Mode	Pin Function ^[6, 7]							
	Read or Output Disable	A ₁₂	A ₁₁	A ₁₀	A ₉	A ₈	CS	O ₇ - O ₀
Program	Program	NA	V _{PP}	LATCH	PGM	VFY	CS	D ₇ - D ₀
Read		A ₁₂	A ₁₁	A ₁₀	A ₉	A ₈	V _{IL}	O ₇ - O ₀
Output Disable		A ₁₂	A ₁₁	A ₁₀	A ₉	A ₈	V _{IH}	High Z
Program		V _{ILP}	V _{PP}	V _{ILP}	V _{ILP}	V _{IHP}	V _{ILP}	D ₇ - D ₀
Program Inhibit		V _{IHP}	V _{PP}	V _{ILP}	V _{IHP}	V _{IHP}	V _{ILP}	High Z
Program Verify		V _{ILP}	V _{PP}	V _{ILP}	V _{IHP}	V _{ILP}	V _{ILP}	O ₇ - O ₀
Blank Check		V _{ILP}	V _{PP}	V _{ILP}	V _{IHP}	V _{ILP}	V _{ILP}	O ₇ - O ₀

Notes:

 6. "X" = "don't care" but not to exceed $V_{CC} \pm 5\%$.

 7. Addresses A₈ - A₁₂ must be latched through lines A₀ - A₄ in programming modes.

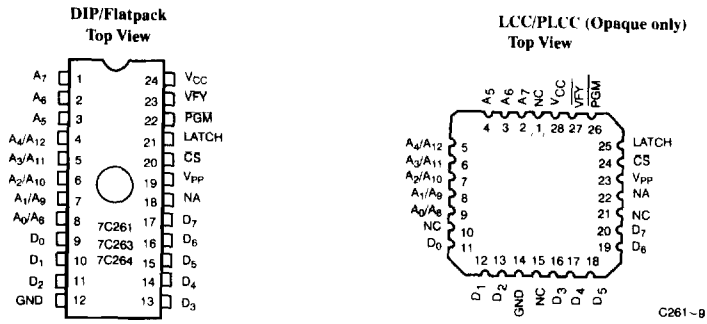

C261-8

C261-9

Figure 1. Programming Pinouts

Typical DC and AC Characteristics

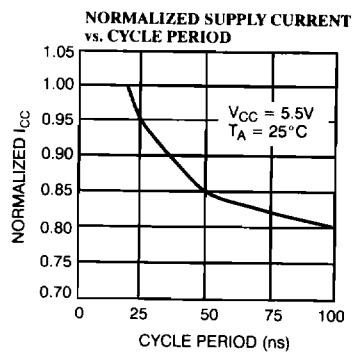
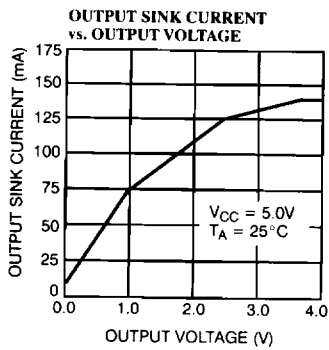
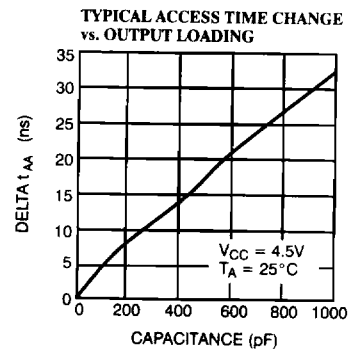
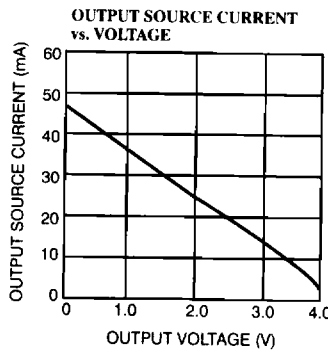
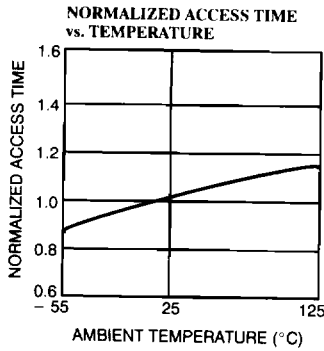
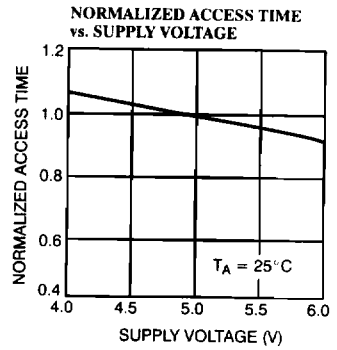
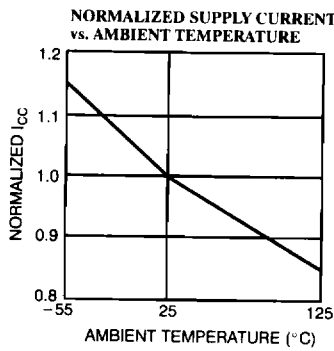
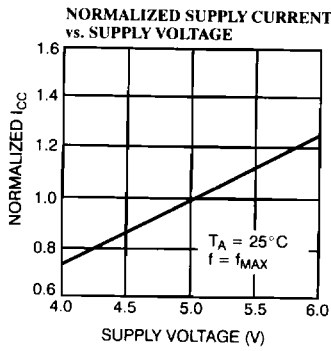



Ordering Information^[8]

Speed (ns)	Ordering Code	Package Name	Package Type	Operating Range
20	CY7C261-20JC	J64	28-Lead Plastic Leaded Chip Carrier	Commercial
	CY7C261-20PC	P13	24-Lead (300-Mil) Molded DIP	
	CY7C261-20WC	W14	24-Lead (300-Mil) Windowed CerDIP	
25	CY7C261-25JC	J64	28-Lead Plastic Leaded Chip Carrier	Commercial
	CY7C261-25PC	P13	24-Lead (300-Mil) Molded DIP	
	CY7C261-25WC	W14	24-Lead (300-Mil) Windowed CerDIP	
	CY7C261-25DMB	D14	24-Lead (300-Mil) CerDIP	Military
	CY7C261-25LMB	L64	28-Square Leadless Chip Carrier	
	CY7C261-25QMB	Q64	28-Pin Windowed Leadless Chip Carrier	
	CY7C261-25TMB	T73	24-Lead Windowed Cerpack	
	CY7C261-25WMB	W14	24-Lead (300-Mil) Windowed CerDIP	
35	CY7C261-35JC	J64	28-Lead Plastic Leaded Chip Carrier	Commercial
	CY7C261-35PC	P13	24-Lead (300-Mil) Molded DIP	
	CY7C261-35WC	W14	24-Lead (300-Mil) Windowed CerDIP	
	CY7C261-35DMB	D14	24-Lead (300-Mil) CerDIP	Military
	CY7C261-35LMB	L64	28-Square Leadless Chip Carrier	
	CY7C261-35QMB	Q64	28-Pin Windowed Leadless Chip Carrier	
	CY7C261-35TMB	T73	24-Lead Windowed Cerpack	
	CY7C261-35WMB	W14	24-Lead (300-Mil) Windowed CerDIP	
45	CY7C261-45JC	J64	28-Lead Plastic Leaded Chip Carrier	Commercial
	CY7C261-45PC	P13	24-Lead (300-Mil) Molded DIP	
	CY7C261-45WC	W14	24-Lead (300-Mil) Windowed CerDIP	
	CY7C261-45DMB	D14	24-Lead (300-Mil) CerDIP	Military
	CY7C261-45LMB	L64	28-Square Leadless Chip Carrier	
	CY7C261-45QMB	Q64	28-Pin Windowed Leadless Chip Carrier	
	CY7C261-45TMB	T73	24-Lead Windowed Cerpack	
	CY7C261-45WMB	W14	24-Lead (300-Mil) Windowed CerDIP	
55	CY7C261-55JC	J64	28-Lead Plastic Leaded Chip Carrier	Commercial
	CY7C261-55PC	P13	24-Lead (300-Mil) Molded DIP	
	CY7C261-55WC	W14	24-Lead (300-Mil) Windowed CerDIP	
	CY7C261-55DMB	D14	24-Lead (300-Mil) CerDIP	Military
	CY7C261-55LMB	L64	28-Square Leadless Chip Carrier	
	CY7C261-55QMB	Q64	28-Pin Windowed Leadless Chip Carrier	
	CY7C261-55TMB	T73	24-Lead Windowed Cerpack	
	CY7C261-55WMB	W14	24-Lead (300-Mil) Windowed CerDIP	

Note:

8. Most of these products are available in industrial temperature range. Contact a Cypress representative for specifications and product availability.



Ordering Information⁽⁸⁾ (continued)

Speed (ns)	Ordering Code	Package Name	Package Type	Operating Range
20	CY7C263-20JC	J64	28-Lead Plastic Leaded Chip Carrier	Commercial
	CY7C263-20PC	P13	24-Lead (300-Mil) Molded DIP	
	CY7C263-20WC	W14	24-Lead (300-Mil) Windowed CerDIP	
25	CY7C263-25JC	J64	28-Lead Plastic Leaded Chip Carrier	Commercial
	CY7C263-25PC	P13	24-Lead (300-Mil) Molded DIP	
	CY7C263-25WC	W14	24-Lead (300-Mil) Windowed CerDIP	
	CY7C263-25DMB	D14	24-Lead (300-Mil) CerDIP	Military
	CY7C263-25LMB	L64	28-Square Leadless Chip Carrier	
	CY7C263-25QMB	Q64	28-Pin Windowed Leadless Chip Carrier	
	CY7C263-25TMB	T73	24-Lead Windowed Cerpack	
	CY7C263-25WMB	W14	24-Lead (300-Mil) Windowed CerDIP	
35	CY7C263-35JC	J64	28-Lead Plastic Leaded Chip Carrier	Commercial
	CY7C263-35PC	P13	24-Lead (300-Mil) Molded DIP	
	CY7C263-35WC	W14	24-Lead (300-Mil) Windowed CerDIP	
	CY7C263-35DMB	D14	24-Lead (300-Mil) CerDIP	Military
	CY7C263-35LMB	L64	28-Square Leadless Chip Carrier	
	CY7C263-35QMB	Q64	28-Pin Windowed Leadless Chip Carrier	
	CY7C263-35TMB	T73	24-Lead Windowed Cerpack	
	CY7C263-35WMB	W14	24-Lead (300-Mil) Windowed CerDIP	
45	CY7C263-45JC	J64	28-Lead Plastic Leaded Chip Carrier	Commercial
	CY7C263-45PC	P13	24-Lead (300-Mil) Molded DIP	
	CY7C263-45WC	W14	24-Lead (300-Mil) Windowed CerDIP	
	CY7C263-45DMB	D14	24-Lead (300-Mil) CerDIP	Military
	CY7C263-45LMB	L64	28-Square Leadless Chip Carrier	
	CY7C263-45QMB	Q64	28-Pin Windowed Leadless Chip Carrier	
	CY7C263-45TMB	T73	24-Lead Windowed Cerpack	
55	CY7C263-55JC	J64	28-Lead Plastic Leaded Chip Carrier	Commercial
	CY7C263-55PC	P13	24-Lead (300-Mil) Molded DIP	
	CY7C263-55WC	W14	24-Lead (300-Mil) Windowed CerDIP	
	CY7C263-55DMB	D14	24-Lead (300-Mil) CerDIP	Military
	CY7C263-55LMB	L64	28-Square Leadless Chip Carrier	
	CY7C263-55QMB	Q64	28-Pin Windowed Leadless Chip Carrier	
	CY7C263-55TMB	T73	24-Lead Windowed Cerpack	
	CY7C263-55WMB	W14	24-Lead (300-Mil) Windowed CerDIP	

4



Ordering Information (continued)^[8]

Speed (ns)	Ordering Code	Package Name	Package Type	Operating Range
20	CY7C264-20DC	D12	24-Lead (600-Mil) CerDIP	Commercial
	CY7C264-20PC	P11	24-Lead (600-Mil) Molded DIP	
	CY7C264-20WC	W12	24-Lead (600-Mil) Windowed CerDIP	
25	CY7C264-25DC	D12	24-Lead (600-Mil) CerDIP	Commercial
	CY7C264-25PC	P11	24-Lead (600-Mil) Molded DIP	
	CY7C264-25WC	W12	24-Lead (600-Mil) Windowed CerDIP	Military
	CY7C264-25DMB	D12	24-Lead (600-Mil) CerDIP	
35	CY7C264-35DC	D12	24-Lead (600-Mil) CerDIP	Commercial
	CY7C264-35PC	P11	24-Lead (600-Mil) Molded DIP	
	CY7C264-35WC	W12	24-Lead (600-Mil) Windowed CerDIP	
	CY7C264-35DMB	D12	24-Lead (600-Mil) CerDIP	Military
	CY7C264-35WMB	W12	24-Lead (600-Mil) Windowed CerDIP	
45	CY7C264-45DC	D12	24-Lead (600-Mil) CerDIP	Commercial
	CY7C264-45PC	P11	24-Lead (600-Mil) Molded DIP	
	CY7C264-45WC	W12	24-Lead (600-Mil) Windowed CerDIP	
	CY7C264-45DMB	D12	24-Lead (600-Mil) CerDIP	Military
	CY7C264-45WMB	W12	24-Lead (600-Mil) Windowed CerDIP	
55	CY7C264-55DC	D12	24-Lead (600-Mil) CerDIP	Commercial
	CY7C264-55PC	P11	24-Lead (600-Mil) Molded DIP	
	CY7C264-55WC	W12	24-Lead (600-Mil) Windowed CerDIP	
	CY7C264-55DMB	D12	24-Lead (600-Mil) CerDIP	Military
	CY7C264-55WMB	W12	24-Lead (600-Mil) Windowed CerDIP	

MILITARY SPECIFICATIONS
Group A Subgroup Testing

DC Characteristics

Parameter	Subgroups
V _{OH}	1, 2, 3
V _{OL}	1, 2, 3
V _{IH}	1, 2, 3
V _{IL}	1, 2, 3
I _{Ix}	1, 2, 3
I _{OZ}	1, 2, 3
I _{CC}	1, 2, 3
I _{SB} ^[9]	1, 2, 3

Switching Characteristics

Parameter	Subgroups
t _{AA}	7, 8, 9, 10, 11
t _{ACS1} ^[10]	7, 8, 9, 10, 11
t _{ACS2} ^[9]	7, 8, 9, 10, 11

Notes:

- 9. 7C261 only.
- 10. 7C263 and 7C264 only.

Document #: 38-00005-J