

A1180/81/82/83

Sensitive Two-Wire Field-Programmable Chopper-Stabilized Unipolar Hall-Effect Switches

Package LH, 3-pin SOT

1. VCC
2. No connection
3. GND

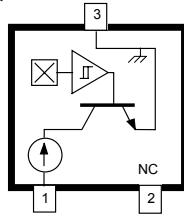

Package UA, 3-pin SIP

1. VCC
2. GND
3. GND

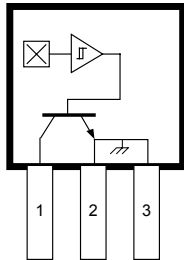

ABSOLUTE MAXIMUM RATINGS

Supply Voltage, V_{CC}	28 V
Reverse-Supply Voltage, V_{RCC}	-18 V
Magnetic Flux Density, B	Unlimited
Operating Temperature	
Ambient, T_A , Range E	-40°C to 85°C
Ambient, T_A , Range L	-40°C to 150°C
Maximum Junction, $T_{J(max)}$	165°C
Storage Temperature, T_S	-65°C to 170°C



The A1180, A1181, A1182, and A1183 devices are sensitive, two-wire, unipolar, Hall effect switches. The operate point, B_{OP} , can be field-programmed, after final packaging of the sensor and placement into the application. This advanced feature allows the optimization of the sensor switching performance, by effectively accounting for variations caused by mounting tolerances for the device and the target magnet.

This family of devices are produced on the Allegro MicroSystems advanced BiCMOS wafer fabrication process, which implements a patented, high-frequency, chopper-stabilization technique that achieves magnetic stability and eliminates the offsets that are inherent in single-element devices exposed to harsh application environments. Commonly found in a number of automotive applications, the A1180-83 family of devices are utilized to sense: seat track position, seat belt buckle presence, hood/trunk latching, and shift selector position.

Two-wire unipolar switches are particularly advantageous in price-sensitive applications, because they require one less wire than the more traditional open-collector output switches. Additionally, the system designer gains inherent diagnostics because output current normally flows in either of two narrowly-specified ranges. Any output current level outside of these two ranges is a fault condition. The A1180-83 family of devices also features on-chip transient protection, and a Zener clamp to protect against overvoltage conditions on the supply line.

The output currents of the A1181 and A1183 switch HIGH in the presence of a south polarity magnetic field of sufficient strength; and switch LOW otherwise, including when there is no significant magnetic field present. The A1180 and A1182 have inverted output current levels: switching LOW in the presence of a south polarity magnetic field of sufficient strength, and HIGH otherwise. The devices also differ in their specified LOW current supply levels.

Both devices are offered in two package styles: LH, a SOT-23W miniature low-profile package for surface-mount applications, and UA, a three-lead ultramini Single Inline Package (SIP) for through-hole mounting. Each package is available in a lead (Pb) free version (suffix, $-T$) with 100% matte tin plated leadframe.

Factory-programmed versions are also available. Refer to: A1140, A1141, A1142, A1143, A1145, and A1146.

Features and Benefits

- Chopper stabilization
- On-chip protection
- Low switchpoint drift over operating temperature range
- Supply transient protection
- Low stress sensitivity
- Reverse-battery protection
- Field-programmable for optimized switchpoints
- On-board voltage regulator
- 3.5 V to 24 V operation

A1180/81/82/83

Sensitive Two-Wire Field-Programmable Chopper-Stabilized Unipolar Hall Effect Switches

Product Selection Guide

Part Number	Pb-free	Packing ¹	Mounting	Ambient, T _A (°C)	Output South (+) Field ²	Supply Current at Low Output, I _{CC(L)} (mA)
A1180ELHLT	–	7-in. reel, 3000 pieces/reel	Surface mount	–40 to 85	Low	2 to 5
A1180ELHLT-T	Yes					
A1180EUA	–	Bulk, 500 pieces/bag	4-pin SIP through hole			
A1180EUA-T	Yes					
A1180LLHLT	–	7-in. reel, 3000 pieces/reel	Surface mount	–40 to 150		
A1180LLHLT-T	Yes					
A1180LUA	–	Bulk, 500 pieces/bag	4-pin SIP through hole			
A1180LUA-T	Yes					
A1181ELHLT	–	7-in. reel, 3000 pieces/reel	Surface mount	–40 to 85	High	
A1181ELHLT-T	Yes					
A1181EUA	–	Bulk, 500 pieces/bag	4-pin SIP through hole			
A1181EUA-T	Yes					
A1181LLHLT	–	7-in. reel, 3000 pieces/reel	Surface mount	–40 to 150		
A1181LLHLT-T	Yes					
A1181LUA	–	Bulk, 500 pieces/bag	4-pin SIP through hole			
A1181LUA-T	Yes					
A1182ELHLT³	–	7-in. reel, 3000 pieces/reel	Surface mount	–40 to 85	Low	5 to 6.9
A1182ELHLT-T	Yes					
A1182EUA	–	Bulk, 500 pieces/bag	4-pin SIP through hole			
A1182EUA-T	Yes					
A1182LLHLT	–	7-in. reel, 3000 pieces/reel	Surface mount	–40 to 150		
A1182LLHLT-T	Yes					
A1182LUA	–	Bulk, 500 pieces/bag	4-pin SIP through hole			
A1182LUA-T	Yes					
A1183ELHLT³	–	7-in. reel, 3000 pieces/reel	Surface mount	–40 to 85	High	
A1183ELHLT-T	Yes					
A1183EUA	–	Bulk, 500 pieces/bag	4-pin SIP through hole			
A1183EUA-T	Yes					
A1183LLHLT	–	7-in. reel, 3000 pieces/reel	Surface mount	–40 to 150		
A1183LLHLT-T	Yes					
A1183LUA	–	Bulk, 500 pieces/bag	4-pin SIP through hole			
A1183LUA-T	Yes					

¹Contact Allegro for additional packing options.

²South (+) magnetic fields must be of sufficient strength.

³These variants are in production but have been determined to be NOT FOR NEW DESIGN. This classification indicates that sale of this device is currently restricted to existing customer applications. The device should not be purchased for new design applications because obsolescence in the near future is probable. Samples are no longer available. Status date change May 2, 2005.

A1180/81/82/83

Sensitive Two-Wire Field-Programmable Chopper-Stabilized Unipolar Hall Effect Switches

ELECTRICAL CHARACTERISTICS over the operating voltage and temperature range, unless otherwise specified

Characteristic	Symbol	Test Conditions	Min.	Typ.	Max.	Units
Supply Voltage ¹	V_{CC}	Device powered on	3.5	–	24	V
Supply Current ²	$I_{CC(L)}$	$B > B_{OP}$ for A1180; $B < B_{RP}$ for A1181	2	–	5	mA
		$B > B_{OP}$ for A1182; $B < B_{RP}$ for A1183	5	–	6.9	mA
	$I_{CC(H)}$	$B > B_{OP}$ for A1181, A1183 $B < B_{RP}$ for A1180, A1182	12	–	17	mA
Supply Zener Clamp Voltage	$V_{Z(supply)}$	$I_{CC} = I_{CC(L)(max)} + 3 \text{ mA}$; $T_A = 25^\circ\text{C}$	28	–	40	V
Supply Zener Clamp Current	$I_{Z(supply)}$	$V_{Z(supply)} = 28 \text{ V}$	–	–	$I_{CC(L)(max)} + 3 \text{ mA}$	mA
Reverse Supply Current	I_{RCC}	$V_{RCC} = -18 \text{ V}$	–	–	-1.6	mA
Output Slew Rate ³	di/dt	No bypass capacitor; capacitance of the oscilloscope performing the measurement = 20 pF	–	36	–	mA/μs
Chopping Frequency	f_C		–	200	–	kHz
Power-On Time ⁴	t_{on}	After factory trimming; with and without bypass capacitor ($C_{BYP} = 0.01 \mu\text{F}$)	–	–	25	μs
Power-On State ^{5,6}	POS	$t_{on} \leq t_{on(max)}$; V_{CC} slew rate $\geq 25 \text{ mV}/\mu\text{s}$	–	HIGH	–	–

¹ V_{CC} represents the generated voltage between the VCC pin and the GND pin.

²Relative values of B use the algebraic convention, where positive values indicate south magnetic polarity, and negative values indicate north magnetic polarity; therefore greater B values indicate a stronger south polarity field (or a weaker north polarity field, if present).

³Measured without bypass capacitor between VCC and GND. Use of a bypass capacitor results in slower current change.

⁴Measured with and without bypass capacitor of 0.01 μF. Adding a larger bypass capacitor causes longer Power-On Time.

⁵POS is defined as true only with a V_{CC} slew rate of 25 mV/μs or greater. Operation with a V_{CC} slew rate less than 25 mV/μs can permanently harm device performance.

⁶POS is undefined for $t > t_{on}$ or $B_{RP} < B < B_{OP}$.

MAGNETIC CHARACTERISTICS¹ over the operating voltage and temperature range, unless otherwise specified

Characteristic	Symbol	Test Conditions	Min.	Typ.	Max.	Units
Programmable Operate Point Range	$B_{OPrange}$	$I_{CC} = I_{CC(H)}$ for A1180 and A1182 $I_{CC} = I_{CC(L)}$ for A1181 and A1183	60	–	200	G
Initial Operate Point Range	B_{OPinit}	$V_{CC} = 12 \text{ V}$	–	33	60	G
Switchpoint Step Size ²	B_{RES}	$V_{CC} = 5 \text{ V}$, $T_A = 25^\circ\text{C}$	4	8	12	G
Number of Programming Bits	–	Switchpoint setting	–	5	–	Bit
		Programming locking	–	1	–	Bit
Temperature Drift of B_{OP}	ΔB_{OP}		–	–	±20	G
Hysteresis	B_{HYS}	$B_{HYS} = B_{OP} - B_{RP}$	5	15	30	G

¹Relative values of B use the algebraic convention, where positive values indicate south magnetic polarity, and negative values indicate north magnetic polarity; therefore greater B values indicate a stronger south polarity field (or a weaker north polarity field, if present).

²The range of values specified for B_{RES} is a maximum, derived from the cumulative programming bit errors.

A1180/81/82/83

Sensitive Two-Wire Field-Programmable Chopper-Stabilized Unipolar Hall Effect Switches

Characteristic Data

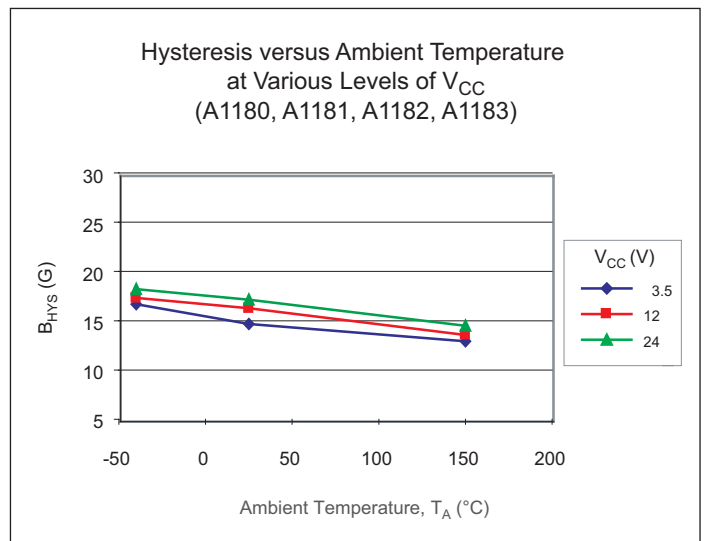
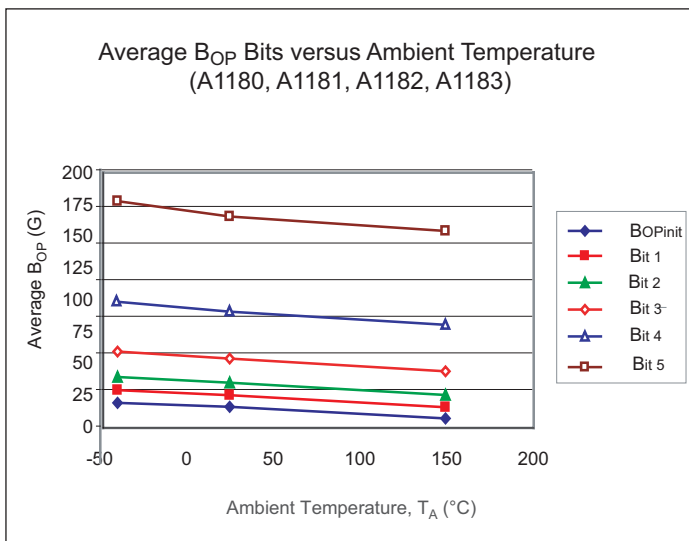
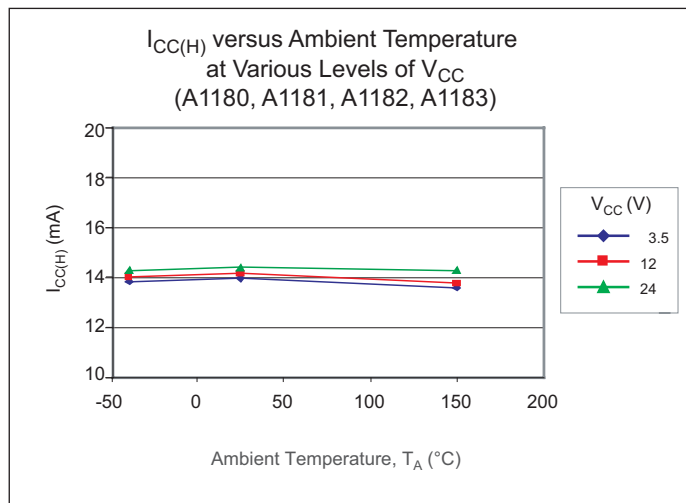
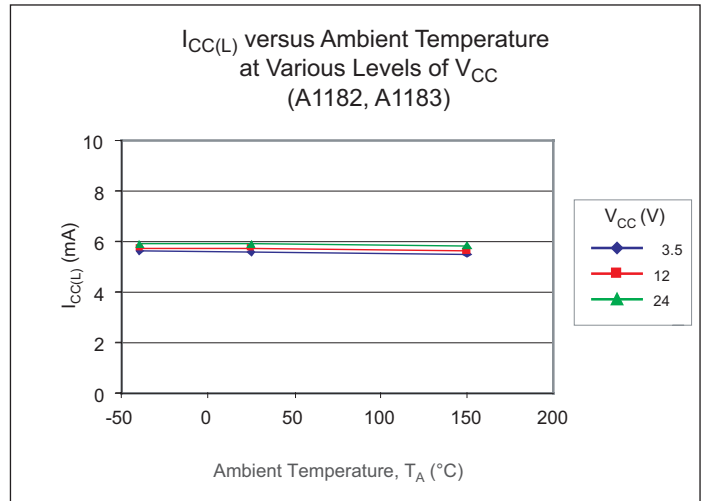
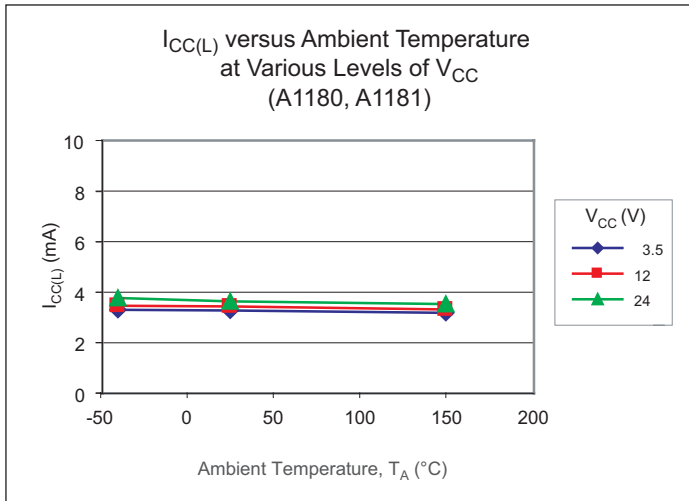

A1180/81/82/83

Sensitive Two-Wire Field-Programmable Chopper-Stabilized Unipolar Hall Effect Switches

Device Qualification Program

Contact Allegro for information.

EMC (Electromagnetic Compatibility) Requirements

Contact your local representative for EMC results.

Test Name	Reference Specification
ESD – Human Body Model	AEC-Q100-002
ESD – Machine Model	AEC-Q100-003
Conducted Transients	ISO 7637-1
Direct RF Injection	ISO 11452-7
Bulk Current Injection	ISO 11452-4
TEM Cell	ISO 11452-3

A1180/81/82/83

Sensitive Two-Wire Field-Programmable Chopper-Stabilized Unipolar Hall Effect Switches

THERMAL CHARACTERISTICS may require derating at maximum conditions, see application information

Characteristic	Symbol	Test Conditions*	Value	Units
Package Thermal Resistance	$R_{\theta JA}$	Package LH, 1-layer PCB with copper limited to solder pads	228	$^{\circ}\text{C}/\text{W}$
		Package LH, 2-layer PCB with 0.463 in. ² of copper area each side connected by thermal vias	110	$^{\circ}\text{C}/\text{W}$
		Package UA, 1-layer PCB with copper limited to solder pads	165	$^{\circ}\text{C}/\text{W}$

*Additional thermal information available on Allegro Web site.

Power Derating Curve

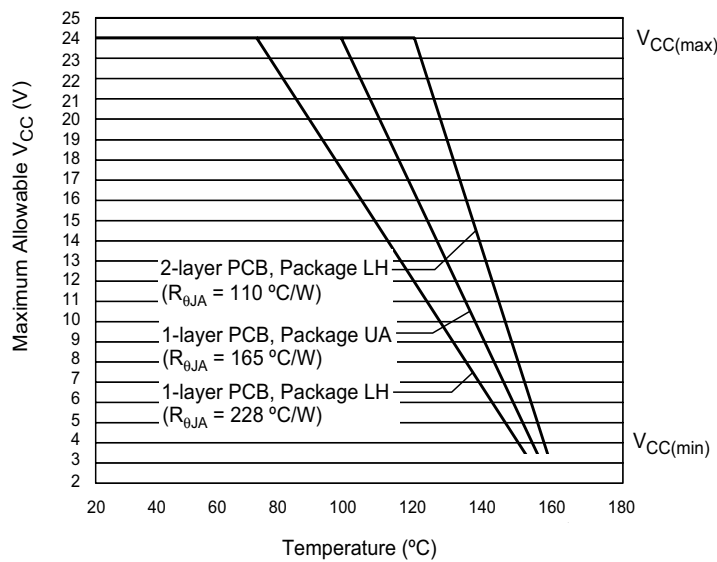

Power Dissipation versus Ambient Temperature

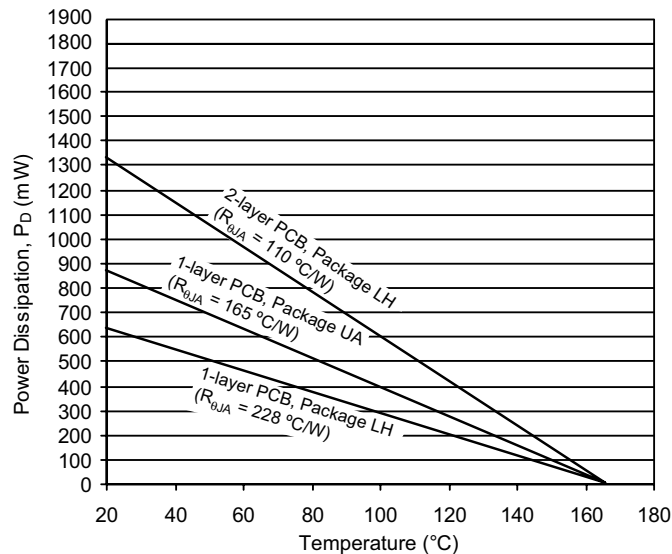

A1180/81/82/83

Sensitive Two-Wire Field-Programmable Chopper-Stabilized Unipolar Hall Effect Switches

Functional Description

Operation

The output, I_{CC} , of the A1180 and A1182 devices switch low after the magnetic field at the Hall sensor exceeds the operate point threshold, B_{OP} . When the magnetic field is reduced to below the release point threshold, B_{RP} , the device output goes high. The differences between the magnetic operate and release point is called the hysteresis of the device, B_{HYS} . This built-

in hysteresis allows clean switching of the output even in the presence of external mechanical vibration and electrical noise. The A1181 and A1183 devices switch with opposite polarity for similar B_{OP} and B_{RP} values, in comparison to the A1180 and A1183 (see figure 1).

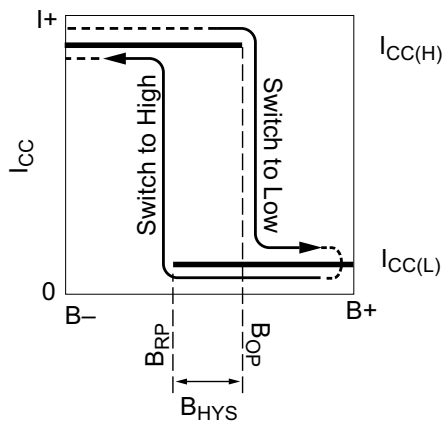

(A) A1180 and A1182

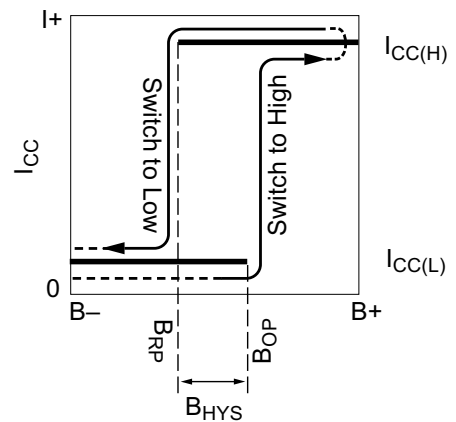

(B) A1181 and A1183

Figure 1. Alternative switching behaviors are available in the A118x device family. On the horizontal axis, the B+ direction indicates increasing south polarity magnetic field strength, and the B- direction indicates decreasing south polarity field strength (including the case of increasing north polarity).

A1180/81/82/83

Sensitive Two-Wire Field-Programmable Chopper-Stabilized Unipolar Hall Effect Switches

Chopper Stabilization Technique

A limiting factor for switchpoint accuracy when using Hall effect technology is the small signal voltage developed across the Hall element. This voltage is proportionally small relative to the offset that can be produced at the output of the Hall sensor device. This makes it difficult to process the signal and maintain an accurate, reliable output over the specified temperature and voltage range.

Chopper stabilization is a unique approach used to minimize Hall offset on the chip. The Allegro patented technique, dynamic quadrature offset cancellation, removes key sources of the output drift induced by temperature and package stress. This offset reduction technique is based on a signal modulation-demodulation process. The undesired offset signal is separated from the magnetically induced signal in the frequency domain through modulation. The subsequent demodulation acts as a modulation process for the offset causing the magnetically induced signal to recover its original spectrum at base band while the dc offset becomes a high frequency signal. Then, using a low-pass filter, the signal passes while the modulated dc offset is suppressed.

The chopper stabilization technique uses a 200 kHz high frequency clock. For demodulation process, a sample-and-hold

technique is used, where the sampling is performed at twice the chopper frequency (400KHz). The sampling demodulation process produces higher accuracy and faster signal processing capability. Using this chopper stabilization approach, the chip is desensitized to the effects of temperature and stress. This technique produces devices that have an extremely stable quiescent Hall output voltage, is immune to thermal stress, and has precise recoverability after temperature cycling. This technique is made possible through the use of a BiCMOS process which allows the use of low-offset and low-noise amplifiers in combination with high-density logic integration and sample-and-hold circuits.

The repeatability of switching with a magnetic field is slightly affected using a chopper technique. The Allegro high frequency chopping approach minimizes the affect of jitter and makes it imperceptible in most applications. Applications that may notice the degradation are those that require the precise sensing of alternating magnetic fields such as ring magnet speed sensing. For those applications, Allegro recommends the “low jitter” family of digital sensors.

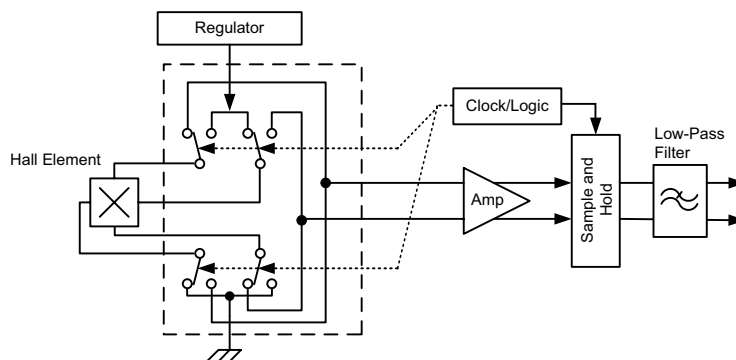

Figure 2. Chopper stabilization circuit (dynamic quadrature offset cancellation)

A1180/81/82/83

Sensitive Two-Wire Field-Programmable Chopper-Stabilized Unipolar Hall Effect Switches

Application Information

For additional general application information, visit the Allegro MicroSystems Web site at www.allegromicro.com.

Typical Application Circuit

The A118x family of devices must be protected by an external bypass capacitor, C_{BYP} , connected between the supply, V_{CC} , and the ground, GND , of the device. C_{BYP} reduces both external noise and the noise generated by the chopper-stabilization function. As shown in figure 3, a 0.01 μF capacitor is typical.

Installation of C_{BYP} must ensure that the traces that connect it to the A118x pins are no greater than 5 mm in length.

All high-frequency interferences conducted along the supply lines are passed directly to the load through C_{BYP} , and it serves only to protect the A118x internal circuitry. As a result, the load ECU (electronic control unit) must have sufficient protection, other than C_{BYP} , installed in parallel with the A118x.

A series resistor on the supply side, R_S (not shown), in combination with C_{BYP} , creates a filter for EMI pulses. (Additional information on EMC is provided on the Allegro MicroSystems Web site.)

When determining the minimum V_{CC} requirement of the A118x device, the voltage drops across R_S and the ECU sense resistor, R_{SENSE} , must be taken into consideration. The typical value for R_{SENSE} is approximately 100 Ω .

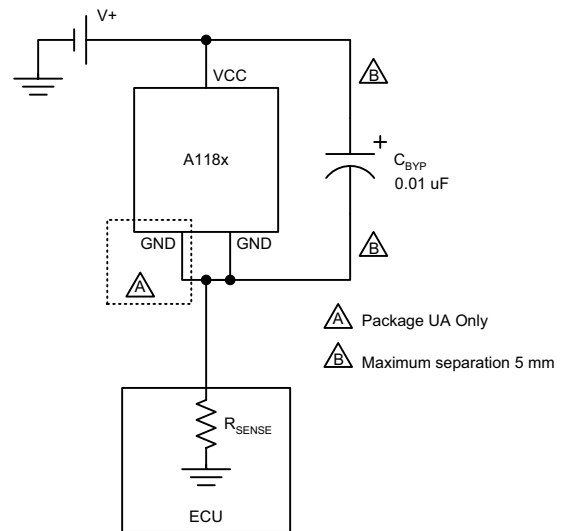

Figure 3. Typical application circuit

Power Derating

The device must be operated below the maximum junction temperature of the device, $T_{J(max)}$. Under certain combinations of peak conditions, reliable operation may require derating supplied power or improving the heat dissipation properties of the application. This section presents a procedure for correlating factors affecting operating T_J . (Thermal data is also available on the Allegro MicroSystems Web site.)

The Package Thermal Resistance, $R_{\theta JA}$, is a figure of merit summarizing the ability of the application and the device to dissipate heat from the junction (die), through all paths to the ambient air. Its primary component is the Effective Thermal Conductivity, K , of the printed circuit board, including adjacent devices and traces. Radiation from the die through the device case, $R_{\theta JC}$, is relatively small component of $R_{\theta JA}$. Ambient air temperature, T_A , and air motion are significant external factors, damped by overmolding.

The effect of varying power levels (Power Dissipation, P_D), can be estimated. The following formulas represent the fundamental relationships used to estimate T_J , at P_D .

$$P_D = V_{IN} \times I_{IN} \quad (1)$$

$$\Delta T = P_D \times R_{\theta JA} \quad (2)$$

$$T_J = T_A + \Delta T \quad (3)$$

For example, given common conditions such as: $T_A = 25^\circ\text{C}$, $V_{CC} = 12\text{ V}$, $I_{CC} = 4\text{ mA}$, and $R_{\theta JA} = 140\text{ }^\circ\text{C/W}$, then:

$$P_D = V_{CC} \times I_{CC} = 12\text{ V} \times 4\text{ mA} = 48\text{ mW}$$

$$\Delta T = P_D \times R_{\theta JA} = 48\text{ mW} \times 140\text{ }^\circ\text{C/W} = 7^\circ\text{C}$$

$$T_J = T_A + \Delta T = 25^\circ\text{C} + 7^\circ\text{C} = 32^\circ\text{C}$$

A worst-case estimate, $P_{D(max)}$, represents the maximum allowable power level ($V_{CC(max)}$, $I_{CC(max)}$), without exceeding $T_{J(max)}$, at a selected $R_{\theta JA}$ and T_A .

Example: Reliability for V_{CC} at $T_A = 150^\circ\text{C}$, package UA, using minimum-K PCB.

Observe the worst-case ratings for the device, specifically: $R_{\theta JA} = 165^\circ\text{C/W}$, $T_{J(max)} = 165^\circ\text{C}$, $V_{CC(max)} = 24\text{ V}$, and $I_{CC(max)} = 17\text{ mA}$.

Calculate the maximum allowable power level, $P_{D(max)}$. First, invert equation 3:

$$\Delta T_{max} = T_{J(max)} - T_A = 165^\circ\text{C} - 150^\circ\text{C} = 15^\circ\text{C}$$

This provides the allowable increase to T_J resulting from internal power dissipation. Then, invert equation 2:

$$P_{D(max)} = \Delta T_{max} \div R_{\theta JA} = 15^\circ\text{C} \div 165\text{ }^\circ\text{C/W} = 91\text{ mW}$$

Finally, invert equation 1 with respect to voltage:

$$V_{CC(est)} = P_{D(max)} \div I_{CC(max)} = 91\text{ mW} \div 17\text{ mA} = 5\text{ V}$$

The result indicates that, at T_A , the application and device can dissipate adequate amounts of heat at voltages $\leq V_{CC(est)}$.

Compare $V_{CC(est)}$ to $V_{CC(max)}$. If $V_{CC(est)} \leq V_{CC(max)}$, then reliable operation between $V_{CC(est)}$ and $V_{CC(max)}$ requires enhanced $R_{\theta JA}$. If $V_{CC(est)} \geq V_{CC(max)}$, then operation between $V_{CC(est)}$ and $V_{CC(max)}$ is reliable under these conditions.

A1180/81/82/83

Sensitive Two-Wire Field-Programmable Chopper-Stabilized Unipolar Hall Effect Switches

Programming Protocol

The operate switchpoint, B_{OP} , can be field-programmed. To do so, a coded series of voltage pulses through the VCC pin is used to set bitfields in onboard registers. The effect on the device output can be monitored, and the registers can be cleared and set repeatedly until the required B_{OP} is achieved. To make the setting permanent, bitfield-level solid state fuses are blown, and finally, a device-level fuse is blown, blocking any further coding. It is not necessary to program the release switchpoint, B_{RP} , because the difference between B_{OP} and B_{RP} , referred to as the hysteresis, B_{HYS} , is fixed.

The range of values between $B_{OP(min)}$ and $B_{OP(max)}$ is scaled to 31 increments. The actual change in magnetic flux (G) represented by each increment is indicated by B_{RES} (see the Operating Characteristics table; however, testing is the only method for verifying the resulting B_{OP}). For programming, the 31 increments are individually identified using 5 data bits, which are physically represented by 5 bitfields in the onboard registers. By setting these bitfields, the corresponding calibration value is programmed into the device.

Three voltage levels are used in programming the device: a low voltage, V_{PL} , a minimum required to sustain register settings; a mid-level voltage, V_{PM} , used to increment the address counter in the device; and a high voltage, V_{PH} , used to separate sets of V_{PM} pulses (when short in duration) and to blow fuses (when long in duration). A fourth voltage level, essentially 0 V, is used to clear the registers between pulse sequences. The pulse values are shown in the Programming Protocol Characteristics table and in figure 4.

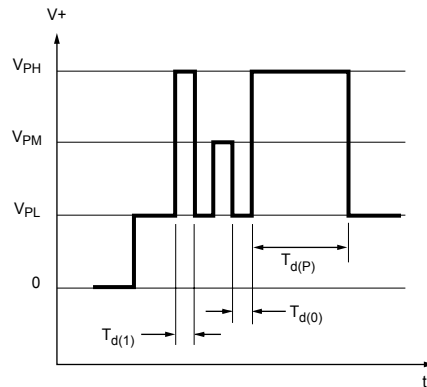

Figure 4. Pulse amplitudes and durations

Additional information on device programming and programming products is available on www.allegromicro.com. Programming hardware is available for purchase, and programming software is available free of charge.

Code Programming. Each bitfield must be individually set. To do so, a pulse sequence must be transmitted for each bitfield that is being set to 1. If more than one bitfield is being set to 1, all pulse sequences must be sent, one after the other, without allowing V_{CC} to fall to zero (which clears the registers).

The same pulse sequence is used to provisionally set bitfields as is used to permanently set bitfield-level fuses. The only difference is that when provisionally setting bitfields, no fuse-blowing pulse is sent at the end of the pulse sequence.

PROGRAMMING PROTOCOL CHARACTERISTICS, over operating temperature range, unless otherwise noted

Characteristic	Symbol	Test Conditions	Min.	Typ.	Max.	Units
Programming Voltage ¹	V_{PL}	Minimum voltage range during programming	4.5	5.0	5.5	V
	V_{PM}		11.5	12.5	13.5	V
	V_{PH}		25.0	26.0	27.0	V
Programming Current ²	I_{PP}	$t_r = 11 \mu s$; $5 V \rightarrow 26 V$; $C_{BY P} = 0.1 \mu F$	-	190	-	mA
Pulse Width	$t_{d(0)}$	OFF time between programming bits	20	-	-	μs
	$t_{d(1)}$	Pulse duration for enable and addressing sequences	20	-	-	μs
	$t_{d(P)}$	Pulse duration for fuse blowing	100	300	-	μs
Pulse Rise Time	t_r	V_{PL} to V_{PM} ; V_{PL} to V_{PH}	5	-	20	μs
Pulse Fall Time	t_f	V_{PM} to V_{PL} ; V_{PH} to V_{PL}	5	-	100	μs

¹Programming voltages are measured at the VCC pin.

²A bypass capacitor with a minimum capacitance of 0.1 μF must be connected from VCC to the GND pin of the A118x device in order to provide the current necessary to blow the fuse.

A1180/81/82/83

Sensitive Two-Wire Field-Programmable Chopper-Stabilized Unipolar Hall Effect Switches

The pulse sequences consist of the following groups of pulses:

1. An enable sequence.
2. A bitfield address sequence.
3. When permanently setting the bitfield, a long V_{PH} fuse-blowing pulse. (Note: Blown bit fuses cannot be reset.)
4. When permanently setting the bitfield, the level of V_{CC} must be allowed to drop to zero between each pulse sequence, in order to clear all registers. However, when provisionally setting bitfields, V_{CC} must be maintained at V_{PL} between pulse sequences, in order to maintain the prior bitfield settings while preparing to set additional bitfields.

Bitfields that are not set are evaluated as zeros. The bitfield-level fuses for 0 value bitfields are never blown. This prevents inad-

vertently setting the bitfield to 1. Instead, blowing the device-level fuse protects the 0 bitfields from being accidentally set in the future.

When provisionally trying the calibration value, one pulse sequence is used, using decimal values. The sequence for setting the value 5_{10} is shown in figure 5.

When permanently setting values, the bitfields must be set individually, and 5_{10} must be programmed as binary 101. Bit 3 is set to 1 (000100_2 , which is 4_{10}), then bit 1 is set to 1 (000001_2 , which is 1_{10}). Bit 2 is ignored, and so remains 0. Two pulse sequences for permanently setting the calibration value 5 are shown in figure 6. The final V_{PH} pulse is maintained for a longer period, enough to blow the corresponding bitfield-level fuse.

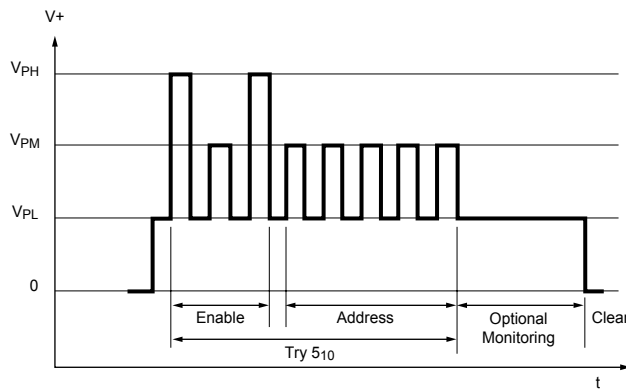

Figure 5. Pulse sequence to provisionally try calibration value 5.

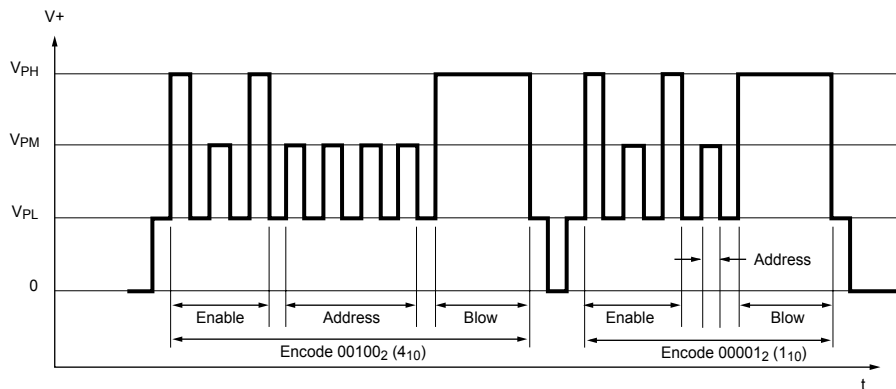

Figure 6. Pulse sequence to permanently encode calibration value 5 (101 binary, or bitfield address 3 and bitfield address 1).

A1180/81/82/83

Sensitive Two-Wire Field-Programmable Chopper-Stabilized Unipolar Hall Effect Switches

Enabling Addressing Mode. The first segment of code is a keying sequence used to enable the bitfield addressing mode. As shown in figure 7, this segment consists of one short V_{PH} pulse, one V_{PM} pulse, and one short V_{PH} pulse, with no supply interruptions. This sequence is designed to prevent the device from being programmed accidentally, such as by noise on the supply line.

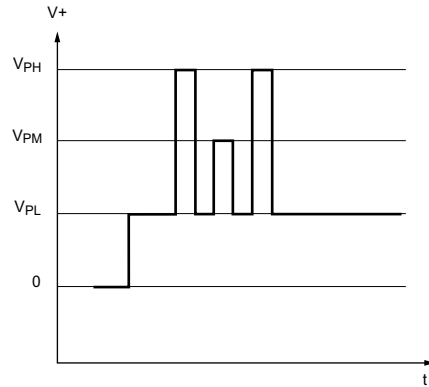

Figure 7. Addressing mode enable pulse sequence

Address Selection. After addressing mode is enabled, the target bitfield address, is indicated by a series of V_{PM} pulses, as shown in figure 8.

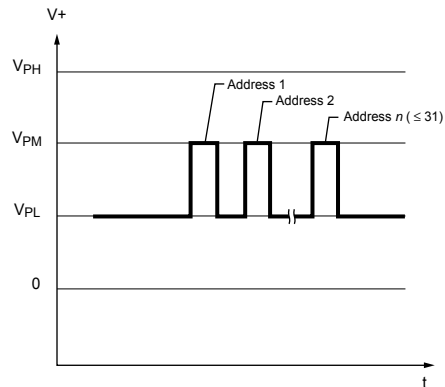

Figure 8. Pulse sequence to select addresses

Lock Bit Programming. After the desired B_{OP} calibration value is programmed, and all of the corresponding bitfield-level fuses are blown, the device-level fuse should be blown. To do so, the lock bit (bitfield address 32) should be encoded as 1 and have its fuse blown. This is done in the same manner as permanently setting the other bitfields, as shown in figure 9.

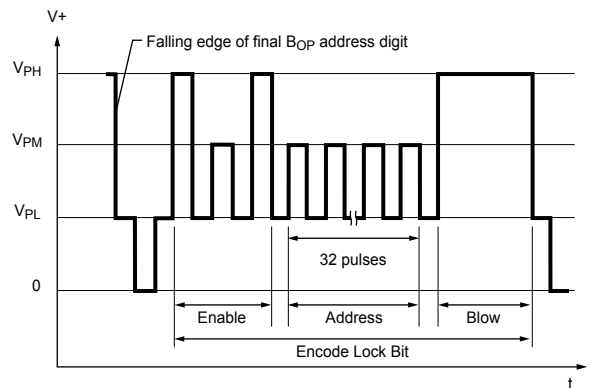
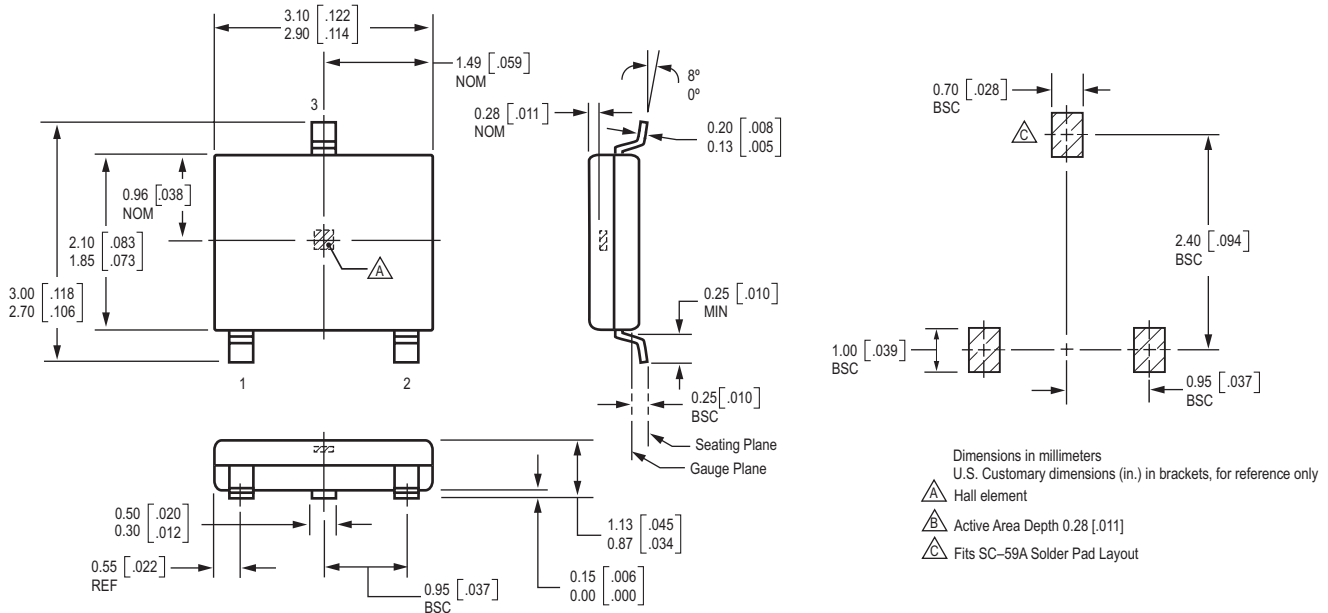

Figure 9. Pulse sequence to encode lock bit

A1180/81/82/83

Sensitive Two-Wire Field-Programmable Chopper-Stabilized Unipolar Hall Effect Switches

Package LH, 3-Pin (SOT-23W)



Package UA, 3-Pin

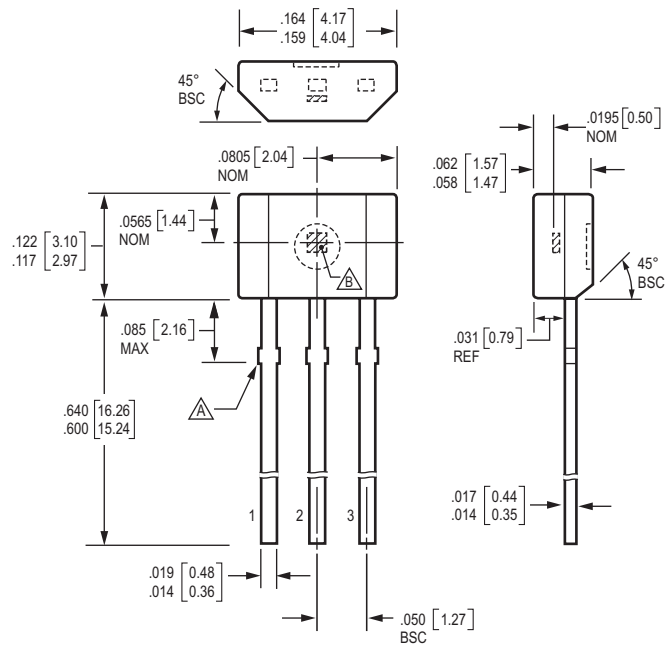

A1180/81/82/83

Sensitive Two-Wire Field-Programmable Chopper-Stabilized Unipolar Hall Effect Switches

The products described herein are manufactured under one or more of the following U.S. patents: 5,045,920; 5,264,783; 5,442,283; 5,389,889; 5,581,179; 5,517,112; 5,619,137; 5,621,319; 5,650,719; 5,686,894; 5,694,038; 5,729,130; 5,917,320; and other patents pending.

Allegro MicroSystems, Inc. reserves the right to make, from time to time, such departures from the detail specifications as may be required to permit improvements in the performance, reliability, or manufacturability of its products. Before placing an order, the user is cautioned to verify that the information being relied upon is current.

Allegro products are not authorized for use as critical components in life-support devices or systems without express written approval.

The information included herein is believed to be accurate and reliable. However, Allegro MicroSystems, Inc. assumes no responsibility for its use; nor for any infringement of patents or other rights of third parties which may result from its use.

Copyright © 2004, 2005 Allegro MicroSystems, Inc.