

SANYO	No.1022A	2SB904/2SD1213
		PNP/NPN Epitaxial Planar Silicon Transistors
30V/20A High-Speed Switching Applications		

Use

- Large current switching of relay drivers, high-speed inverters, converters

Features

- Low collector-to-emitter saturation voltage: $V_{CE(sat)} = -0.5V$ (PNP), 0.4 (NPN) max.
- Large current capacity

(): 2SB904

Absolute Maximum Ratings/ $T_a=25^\circ C$

			unit
Collector-to-Base Voltage	V_{CBO}	(-)60	V
Collector-to-Emitter Voltage	V_{CEO}	(-)30	V
Emitter-to-Base Voltage	V_{EBO}	(-)6	V
Collector Current	I_C	(-)20	A
Collector Current (Pulse)	I_{CP}	(-)30	A
Collector Dissipation	P_C	2.5	W
		$T_c=25^\circ C$	60
Junction Temperature	T_j	150	$^\circ C$
Storage Temperature	T_{stg}	-55 to +150	$^\circ C$

Electrical Characteristics/ $T_a=25^\circ C$

			min	typ	max	unit
Collector Cutoff Current	I_{CBO}	$V_{CB} = (-)40V, I_E = 0$			(-)0.1	mA
Emitter Cutoff Current	I_{EBO}	$V_{EB} = (-)4V, I_C = 0$			(-)0.1	mA
Common emitter DC Current Gain	$h_{FE(1)}$	$V_{CE} = (-)2V, I_C = (-)1A$	70*		280*	
	$h_{FE(2)}$	$V_{CE} = (-)2V, I_C = (-)10A$	30			
Collector to Emitter Saturation Voltage	$V_{CE(sat)}$	$I_C = (-)8A, I_B = (-)0.4A$		(-0.25)	(-0.5)	V
				0.2	0.4	
Gain Band-width Product	f_T	$V_{CE} = (-)5V, I_C = (-)1A$		120		MHz
Collector-to-Base Breakdown Voltage	$V_{(BR)CBO}$	$I_C = (-)1mA, I_E = 0$	(-)60			V
Collector-to-Emitter Breakdown Voltage	$V_{(BR)CEO}$	$I_C = (-)1mA, R_{BE} = \infty$	(-)30			V
Emitter-to-Base Breakdown Voltage	$V_{(BR)EBO}$	$I_E = (-)1mA, I_C = 0$	(-)6			V
Turn-on Time	t_{on}	See specified Test Circuit		300		ns
Storage Time	t_{stg}	"		(300)600		ns
Fall Time	t_f	"		20		ns

*The 2SB904/2SD1213 are classified as follows according to h_{FE} at 1A.

70	Q	140	100	R	200	140	S	280
----	---	-----	-----	---	-----	-----	---	-----

Switching Time Test Circuit (For PNP, the polarity is reversed)

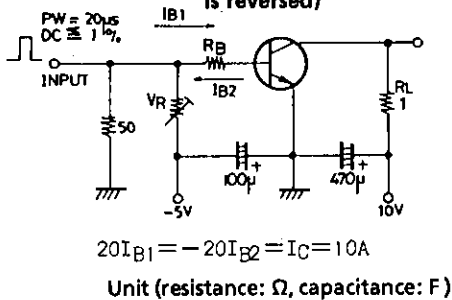

Package Dimensions 2022

(unit: mm)

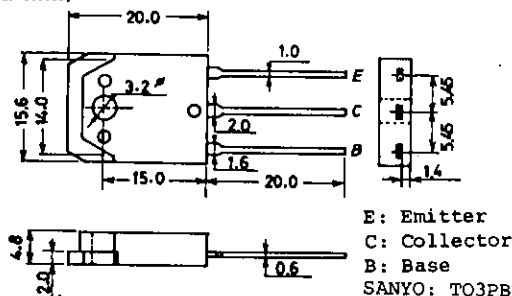

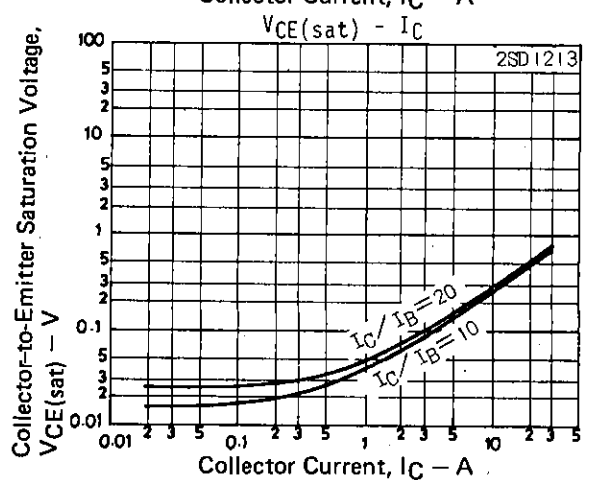
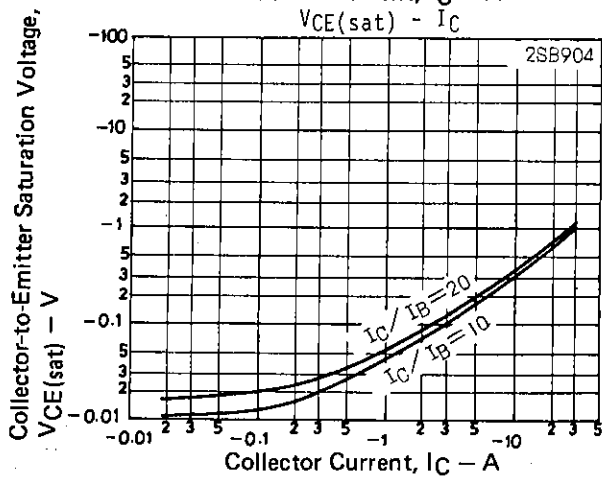
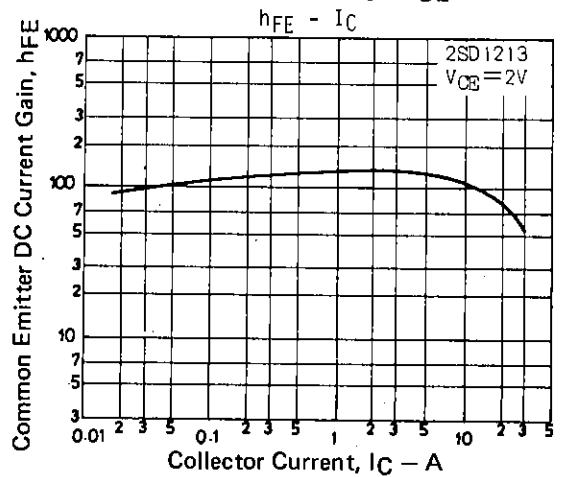
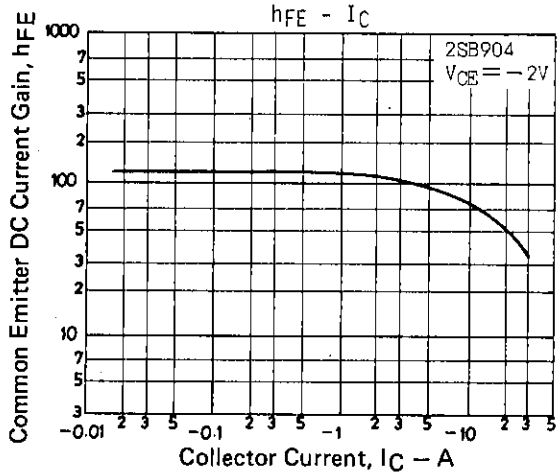
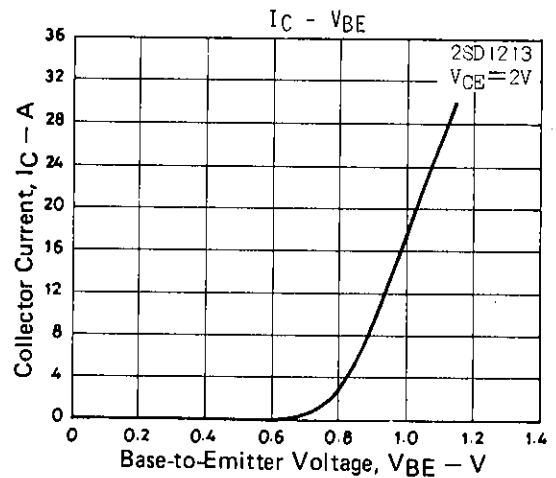
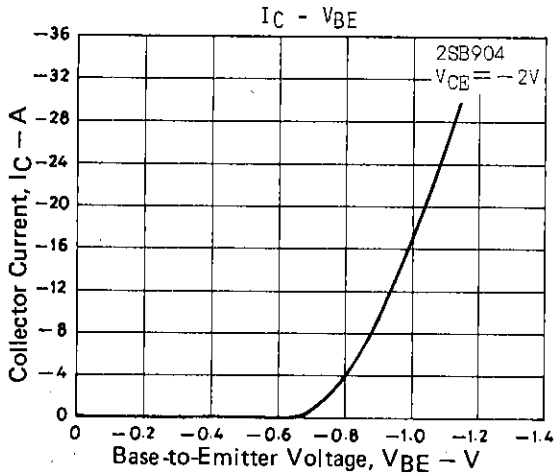
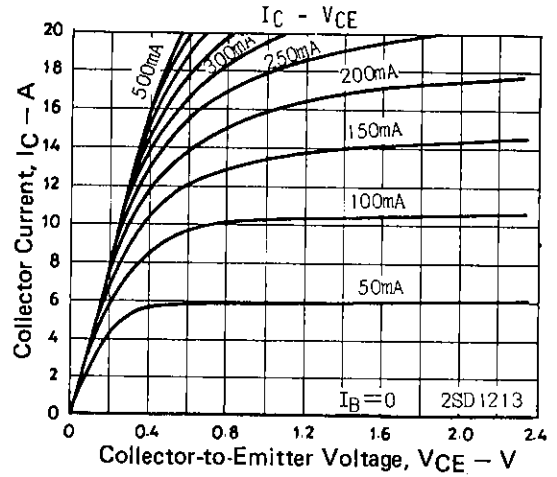
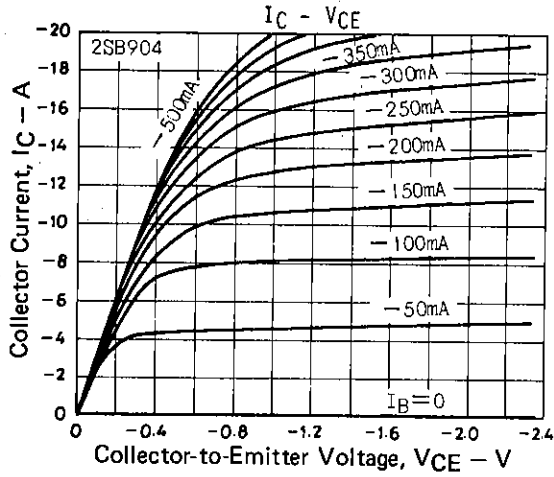

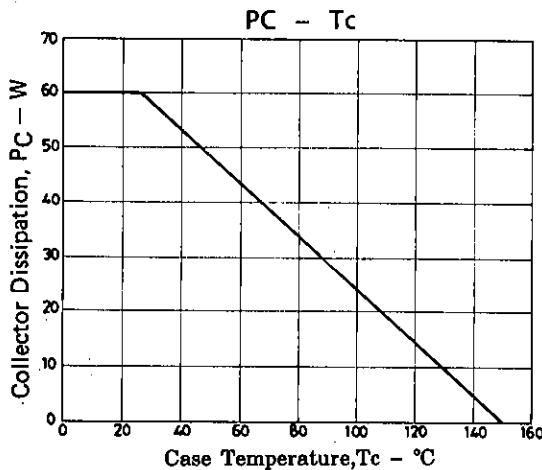
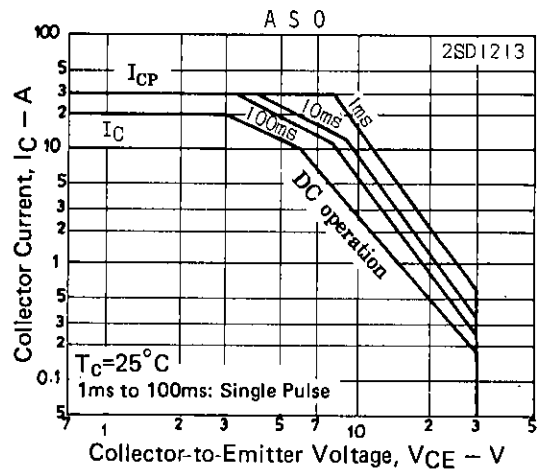
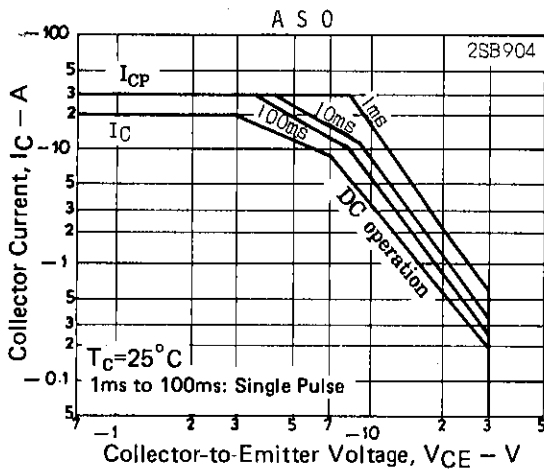
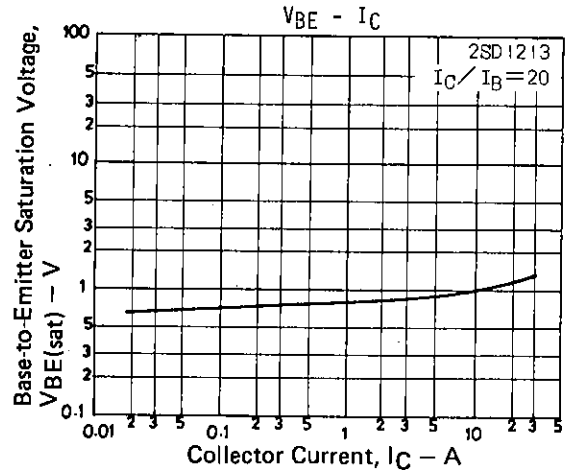
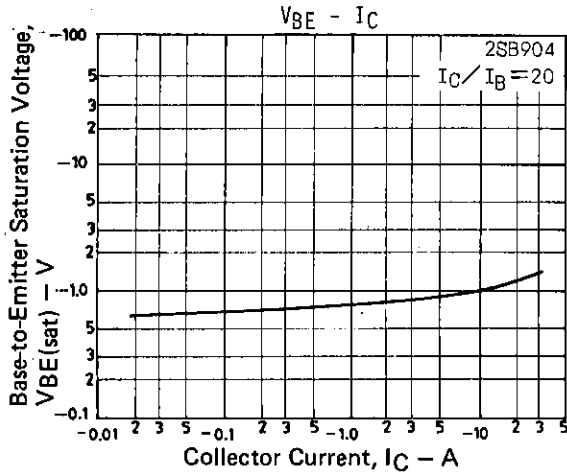

- No products described or contained herein are intended for use in surgical implants, life-support systems, aerospace equipment, nuclear power control systems, vehicles, disaster/crime-prevention equipment and the like, the failure of which may directly or indirectly cause injury, death or property loss.
- Anyone purchasing any products described or contained herein for an above-mentioned use shall:
 - ① Accept full responsibility and indemnify and defend SANYO ELECTRIC CO., LTD., its affiliates, subsidiaries and distributors and all their officers and employees, jointly and severally, against any and all claims and litigation and all damages, cost and expenses associated with such use:
 - ② Not impose any responsibility for any fault or negligence which may be cited in any such claim or litigation on SANYO ELECTRIC CO., LTD., its affiliates, subsidiaries and distributors or any of their officers and employees jointly or severally.
- Information (including circuit diagrams and circuit parameters) herein is for example only; it is not guaranteed for volume production. SANYO believes information herein is accurate and reliable, but no guarantees are made or implied regarding its use or any infringements of intellectual property rights or other rights of third parties.