

1015MP

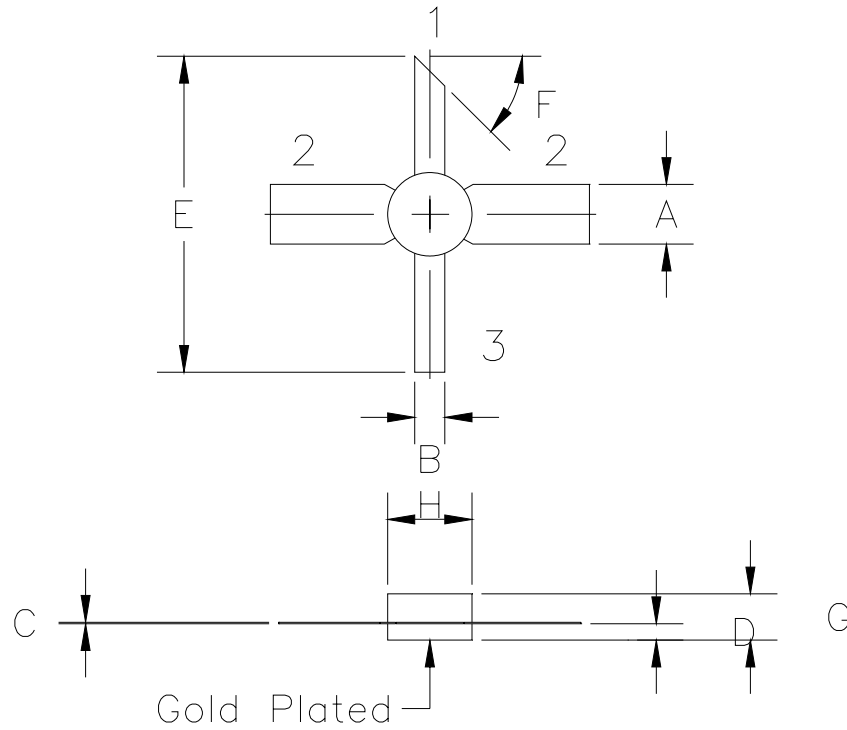

STYLE 1:
 PIN1 = COLLECTOR
 2 = BASE (2X)
 3 = EMITTER

STYLE 2:
 PIN1 = COLLECTOR
 2 = EMITTER (2X)
 3 = BASE

DIM	MILLIMETER	±TOL	INCHES	±TOL
A	5.08	.13	.200	.005
B	7.11 DIA	.13	.280 DIA	.005
C	0.13	.02	.005	.001
D	1.40	.13	.055	.005
E	26.92	.64	1.060	.025
F	45°	5°	45°	5°
G	3.94	REF	.155	REF
H	2.54	.13	.100	.005

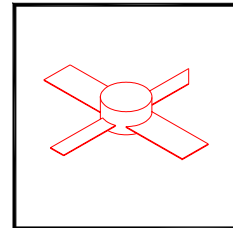

GHz TECHNOLOGY
 RF - MICROWAVE SILICON POWER TRANSISTORS

DWG NO.

55FW