

Infrared LED

L1939 series

$\phi 300 \mu\text{m}$ emission spot, no electrode in emission area



Features

- Small emission spot: $\phi 300 \mu\text{m}$
- Wide directivity
- High reliability, long life

Applications

- Auto-focus
- Optical switches
- Mark sensors

■ Absolute maximum ratings ($T_a=25^\circ\text{C}$)

Parameter	Symbol	Condition	Value	Unit
Forward current	I_F		100	mA
Reverse voltage	V_R		5	V
Pulse forward current	I_{FP}	Pulse width=10 μs Duty ratio=1 %	1.5	A
Operating temperature	T_{opr}		-30 to +85	$^\circ\text{C}$
Storage temperature	T_{stg}		-40 to +100 *	$^\circ\text{C}$

* L1939 is guaranteed to resist temperature cycle test of up to 5 cycles.

■ Electrical and optical characteristics ($T_a=25^\circ\text{C}$)

Parameter	Symbol	Condition	L1939			L1939-04			Unit
			Min.	Typ.	Max.	Min.	Typ.	Max.	
Peak emission wavelength	λ_p	$I_F=50 \text{ mA}$	870	890	920	870	890	920	nm
Spectral half width	$\Delta\lambda$	$I_F=50 \text{ mA}$	-	50	-	-	50	-	nm
Forward voltage	V_F	$I_F=50 \text{ mA}$	-	1.4	1.5	-	1.4	1.5	V
Pulse forward voltage	V_{FP}	$I_F=1.5 \text{ A}$	-	2.7	3.4	-	2.7	3.4	V
Reverse current	I_R	$V_R=5 \text{ V}$	-	-	5	-	-	5	μA
Radiant flux	ϕ_e	$I_F=50 \text{ mA}$	8.0	10.0	-	2.0	2.8	-	mW
Radiant illuminance	P_E	$I_F=50 \text{ mA}$	-	0.4	-	-	0.35	-	mW/cm^2
Rise time	t_r	$I_F=50 \text{ mA}$, 10 to 90 %	-	0.45	0.7	-	0.45	0.7	μs
Fall time	t_f	$I_F=50 \text{ mA}$, 90 to 10 %	-	0.45	0.7	-	0.45	0.7	μs

Emission spectrum

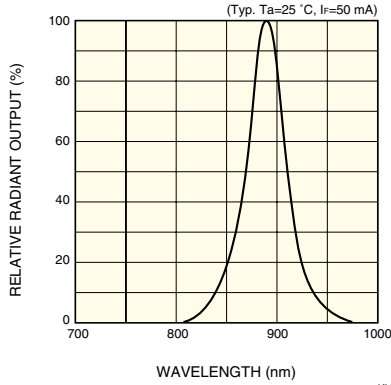

Radiant flux vs. forward current

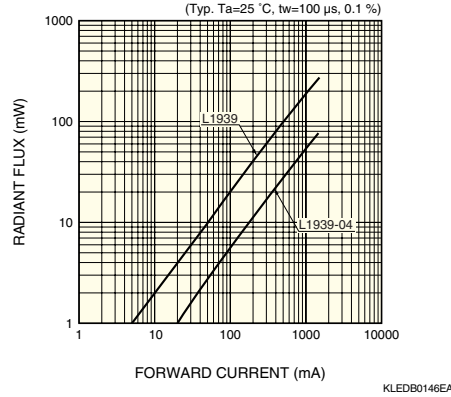

Forward current vs. forward voltage

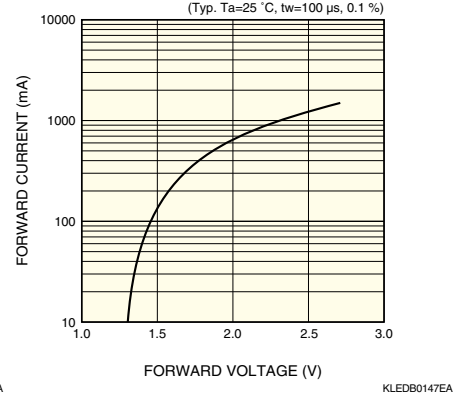

Directivity

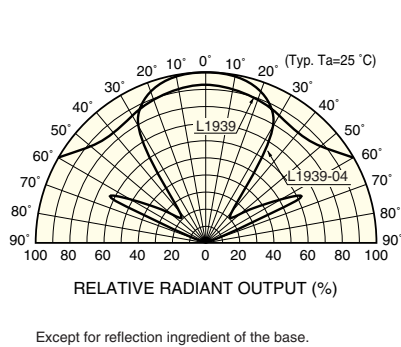

Radiant output vs. ambient temperature

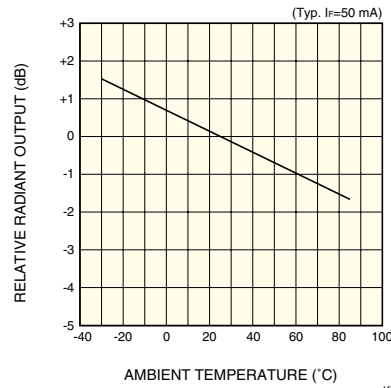

Allowable forward current vs. ambient temperature

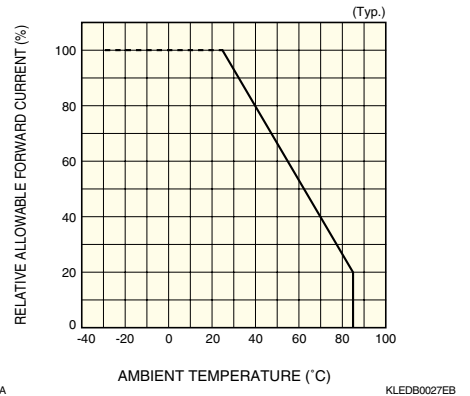

Allowable forward current vs. duty ratio

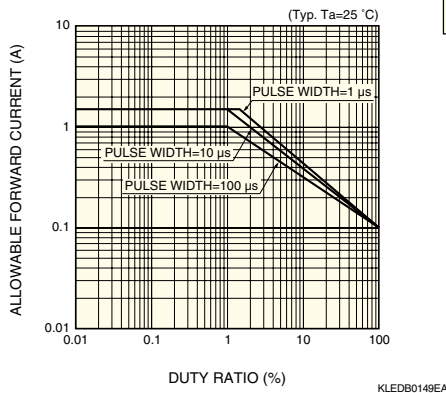

Dimensional outlines (unit: mm)

① L1939

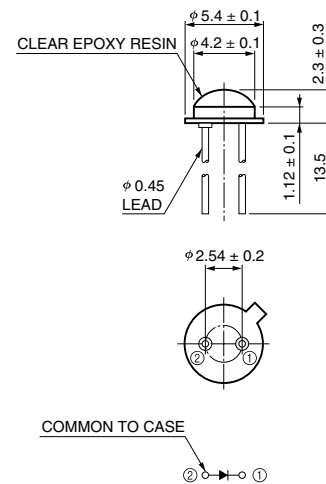

② L1939-04

