

OUTLINE

The R1100D Series are CMOS-based voltage regulator ICs with high accuracy output voltage and ultra-low supply current developed. Each of these ICs consists of a driver transistor, a voltage reference unit, an error amplifier, resistors for setting output voltage and a current limit circuit.

The output voltage of these ICs is fixed with high accuracy.

Even if V_{OUT} is shorted to the GND, the included current limit circuit protects the ICs from the destruction.

Since the package for these ICs is SON1408-3, high density mounting of the ICs on boards is possible.

FEATURES

- Ultra-low supply current Typ. $0.8\mu\text{A}$ ($V_{OUT}=1.0\text{V}, V_{DD}=3.0\text{V}$)
- Dropout Voltage Typ. 20mV ($I_{OUT}=1\text{mA}, V_{OUT}=3.0\text{V}$)
- Low Temperature-Drift Coefficient of Detector Threshold Typ. $\pm 100\text{ppm}/^\circ\text{C}$
- Excellent Line Regulation Typ. $0.05\%/V$
- High Accuracy Output Voltage $\pm 2.0\%$ ($1.2\text{V} \leq V_{OUT} \leq 4.0\text{V}$),
 $\pm 24\text{mV}$ ($V_{OUT} < 1.2\text{V}$)
- Ultra-Small Package SON1408-3
- Built-in Current Limit Circuit

APPLICATIONS

- Power source for battery-powered equipment.
- Power source for cameras, VCRs, camcorders, hand-held audio instruments and hand-held communication equipment.
- Precision voltage references.

BLOCK DIAGRAMS

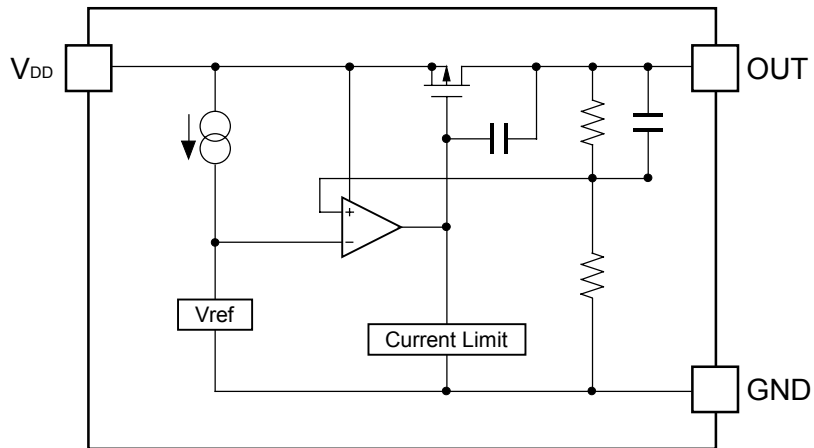

SELECTION GUIDE

The output voltage, the active type, and the packing type for the ICs can be selected at the user's request. The selection can be made with designating the part number as shown below:

R1100xxx1C-xx ←Part Number
 ↑ ↑ ↑ ↑ ↑
 a b cd e

Code	Contents
a	Designation of Package Type D: SON1408-3
b	Setting Output Voltage (V_{OUT}): Stepwise setting with a step of 0.1V in the range of 0.9V to 4.0V is possible.
c	1 : Fixed
d	C : Fixed
e	Designation of Taping Type: TR (Refer to Taping Specifications)

PIN CONFIGURATION

● SON1408-3

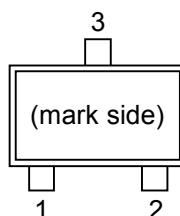

PIN DESCRIPTION

● SON1408-3

Pin No.	Symbol	Description
1	V_{OUT}	Output Pin
2	V_{DD}	Input Pin
3	GND	Ground Pin

ABSOLUTE MAXIMUM RATINGS

Symbol	Item	Rating	Unit
V_{IN}	Supply Voltage	6.5	V
V_{OUT}	Output Voltage	$V_{SS}-0.3$ to $V_{IN}+0.3$	V
I_{OUT}	Output Current	180	mA
P_D	Power Dissipation (SON1408-3) ^{*Note1}	250	mW
T_{opt}	Operating Temperature	-40 to +85	°C
T_{stg}	Storage Temperature	-55 to +125	°C
T_{solder}	Soldering Temperature	260°C, 10s	

*Note 1: This specification is at mounted on board.

P_D depends on conditions of mounting on board. This specification is based on the measurement at the condition below:

*Measurement Conditions

Environment: Mounted on board (Wind velocity 0m/s)

Board Material: FR-4 (2-layer)

Board dimensions : 40mm × 40mm × t1.6mm

Copper Area : 50%

Tab (3pin) pattern width is same as lead width and connected to GND plane.

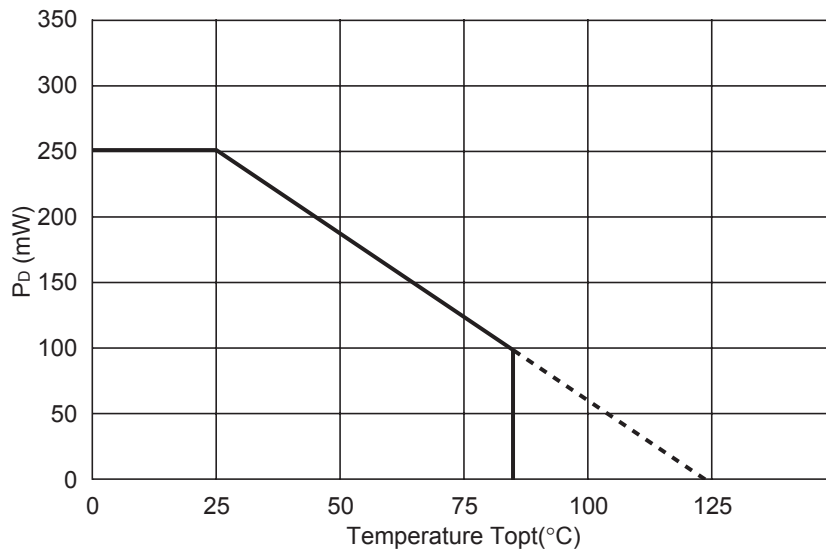

ELECTRICAL CHARACTERISTICS

- R1100D301C

Topt=25°C

Symbol	Item	Test Conditions	Min.	Typ.	Max.	Unit
V_{OUT}	Output Voltage	$V_{IN}=5.0V$ $10\mu A \leq I_{OUT} \leq 10mA$	2.940	3.000	3.060	V
I_{OUT}	Output Current	$V_{IN}=5.0V$	100			mA
$\Delta V_{OUT}/\Delta I_{OUT}$	Load Regulation	$V_{IN}=5.0V, 1mA \leq I_{OUT} \leq 50mA$		35	60	mV
V_{DIF}	Dropout Voltage	$I_{OUT}=1mA$		20	30	mV
I_{SS}	Supply Current	$V_{IN}=5.0V$		1.5	3.0	μA
$\Delta V_{OUT}/\Delta V_{IN}$	Line Regulation	$I_{OUT}=1mA$ $V_{OUT}+0.5V \leq V_{IN} \leq 6.0V$	-0.20		0.20	%/V
V_{IN}	Input Voltage				6.0	V
$\Delta V_{OUT}/\Delta T$	Output Voltage Temperature Coefficient	$I_{OUT}=10mA$ $-40^{\circ}C \leq T_{opt} \leq 85^{\circ}C$		± 100		ppm/ °C
I_{LIM}	Short Current Limit	$V_{OUT}=0V$		40		mA

ELECTRICAL CHARACTERISTICS BY OUTPUT VOLTAGE

T_{opt}=25°C

Part Number	Output Voltage				Output Current			Load Regulation			Dropout Voltage					
	V _{OUT} [V]				I _{OUT} [mA]			ΔV _{OUT} /ΔI _{OUT} [mV]			V _{DIF} [mV]					
	Condi- tions	MIN.	TYP.	MAX.	Condi- tions	MIN.	TYP.	Condi- tions	TYP.	MAX.	Condi- tions	TYP.	MAX.			
R1100D091C	V _{IN} -V _{OUT} =2.0V 10μA ≧ I _{OUT} ≧ 10mA	0.876	0.900	0.924	V _{IN} - V _{OUT} =2.0V	35		V _{IN} -V _{OUT} =2.0V 1mA ≧ I _{OUT} ≧ 20mA	7.5	20	I _{OUT} =1mA	380	750			
R1100D101C		0.976	1.000	1.024								280	700			
R1100D111C		1.076	1.100	1.124								200	600			
R1100D121C		1.176	1.200	1.224								100	400			
R1100D131C		1.274	1.300	1.326												
R1100D141C		1.372	1.400	1.428								50	100			
R1100D151C		1.470	1.500	1.530												
R1100D161C		1.568	1.600	1.632								65		V _{IN} -V _{OUT} =2.0V 1mA ≧ I _{OUT} ≧ 35mA	20	40
R1100D171C		1.666	1.700	1.734												
R1100D181C		1.764	1.800	1.836												
R1100D191C		1.862	1.900	1.938												
R1100D201C		1.960	2.000	2.040												
R1100D211C		2.058	2.100	2.142												
R1100D221C		2.156	2.200	2.244												
R1100D231C		2.254	2.300	2.346												
R1100D241C		2.352	2.400	2.448												
R1100D251C		2.450	2.500	2.550												
R1100D261C		2.548	2.600	2.652		100		V _{IN} -V _{OUT} =2.0V 1mA ≧ I _{OUT} ≧ 50mA	35	60						
R1100D271C		2.646	2.700	2.754												
R1100D281C		2.744	2.800	2.856												
R1100D291C	2.842	2.900	2.958													
R1100D301C	2.940	3.000	3.060													
R1100D311C	3.038	3.100	3.162													
R1100D321C	3.136	3.200	3.264													
R1100D331C	3.234	3.300	3.366													
R1100D341C	3.332	3.400	3.468													
R1100D351C	3.430	3.500	2.570													
R1100D361C	3.528	3.600	3.672													
R1100D371C	3.626	3.700	3.774													
R1100D381C	3.724	3.800	3.876													
R1100D391C	3.822	3.900	3.978													
R1100D401C	3.920	4.000	4.080													

ELECTRICAL CHARACTERISTICS

(Common characteristics)

Symbol	Item	Test Conditions	Min.	Typ.	Max.	Unit
$\Delta V_{OUT}/\Delta V_{IN}$	Line Regulation	$I_{OUT}=1\text{mA}$ $\text{SET } V_{OUT}+0.5\text{V} \leq V_{IN} \leq 6\text{V}$	-0.20		0.20	%/V
V_{IN}	Input Voltage		(1.2)		6.0	V
$\Delta V_{OUT}/\Delta T_{opt}$	Output Voltage Temperature Coefficient	$I_{OUT}=10\text{mA}$ $-40^{\circ}\text{C} \leq T_{opt} \leq 85^{\circ}\text{C}$		± 100		ppm/ $^{\circ}\text{C}$
I_{LIM}	Short Current Limit	$V_{OUT}=0\text{V}$		40		mA

ELECTRICAL CHARACTERISTICS BY OUTPUT VOLTAGE

Symbol	Item	Output Voltage	Conditions	Min.	Typ.	Max.	Unit
I_{SS}	Supply Current	$0.9\text{V} \leq V_{OUT} \leq 1.0\text{V}$	$V_{IN}=\text{SET } V_{OUT}+2.0\text{V}$		0.8	1.8	μA
		$1.1\text{V} \leq V_{OUT} \leq 1.4\text{V}$			1.0	2.4	
		$1.5\text{V} \leq V_{OUT} \leq 2.0\text{V}$			1.2	2.7	
		$2.1\text{V} \leq V_{OUT} \leq 4.0\text{V}$			1.5	3.0	

OPERATION

these ICs, the output voltage V_{OUT} is detected by Feedback Registers, and the detected output voltage is compare with a reference voltage by the error amplifier, so that a constant voltage is output.

A current limit circuit against short protection and a chip enable circuit are included.

TEST CIRCUITS

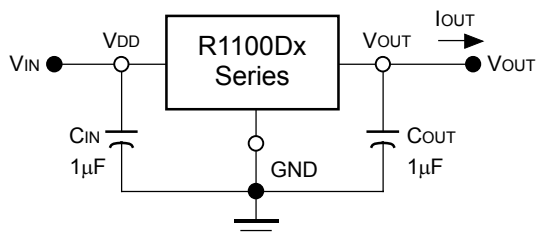

Standard Test Circuit

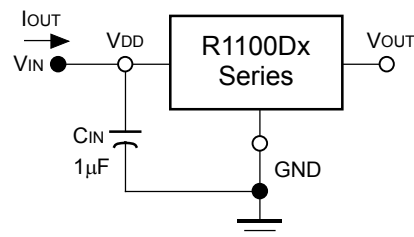

Test Circuit for Supply Current

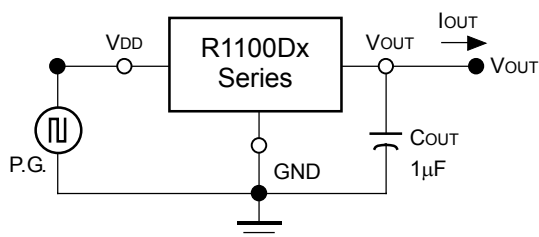

Test Circuit for Line Transient Response

TYPICAL CHARACTERISTICS

1) Output Voltage vs. Output Current

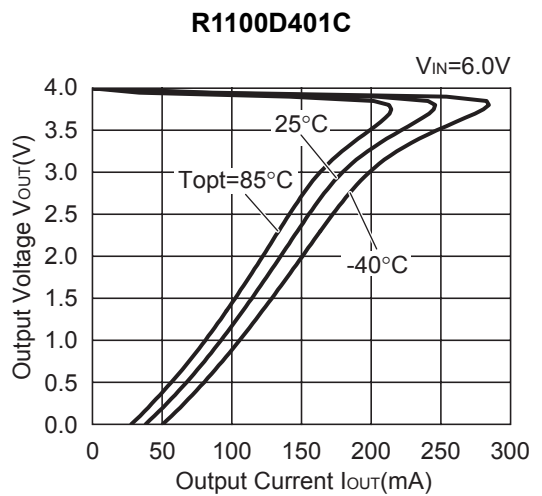
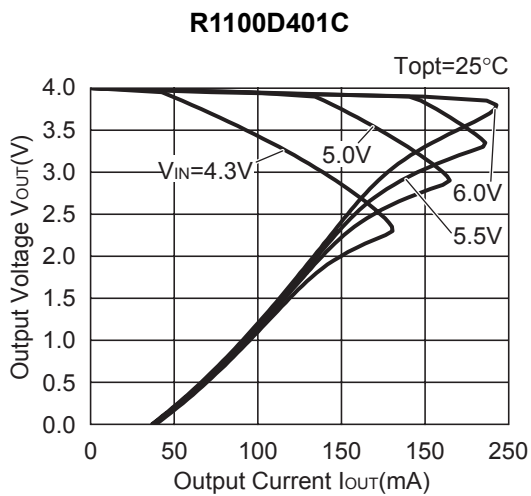
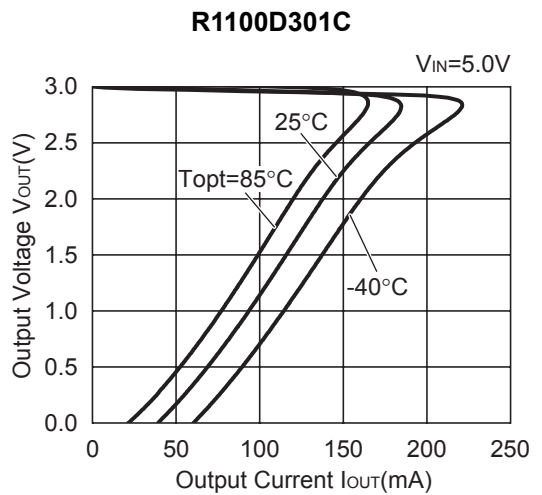
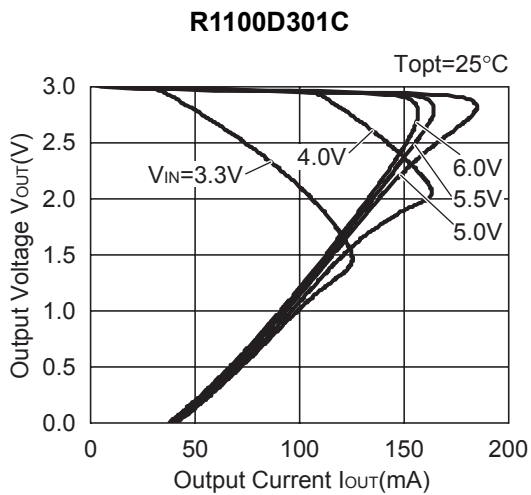
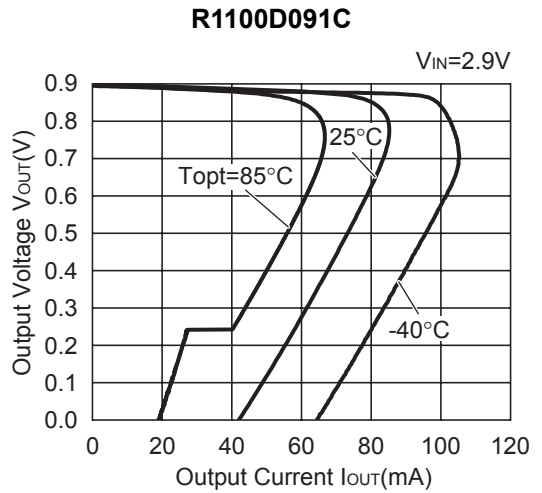
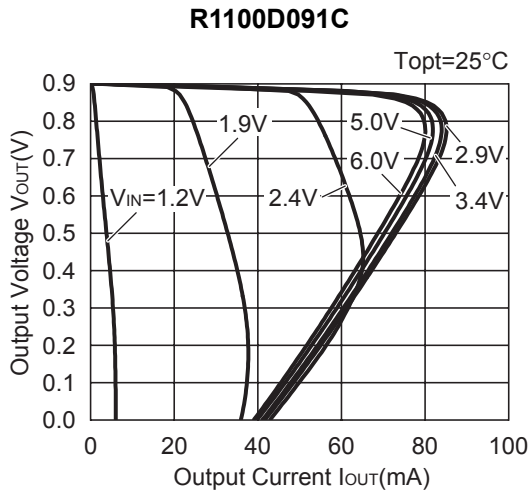

2) Output Voltage vs. Input Voltage

R1100D091C

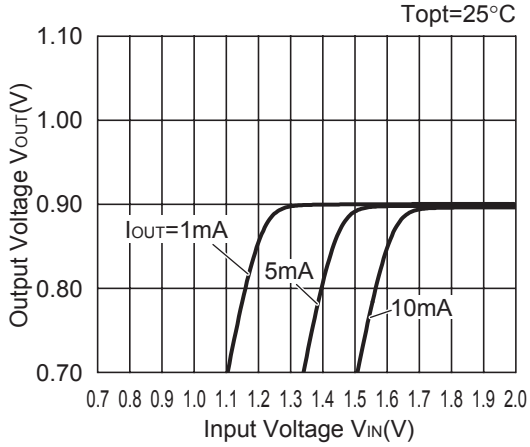

R1100D091C

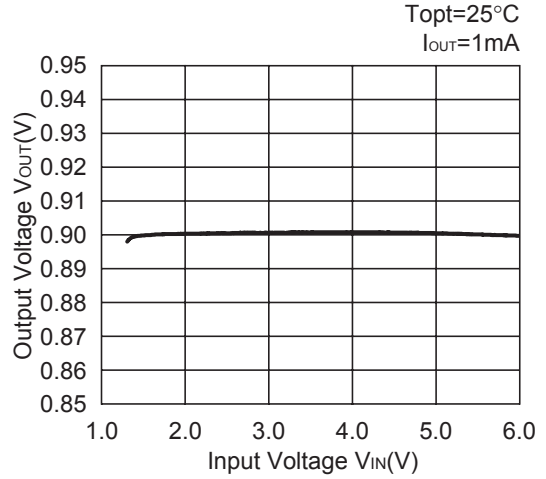

R1100D301C

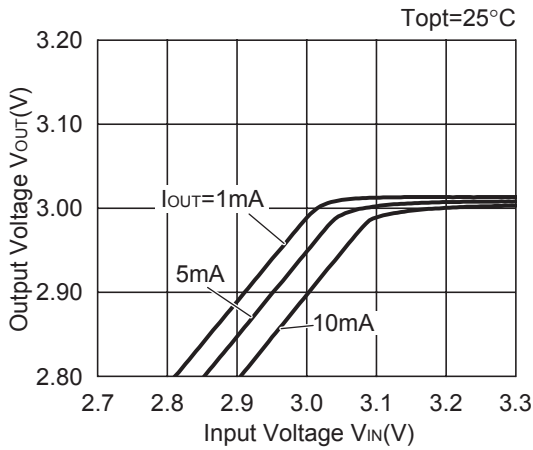

R1100D301C

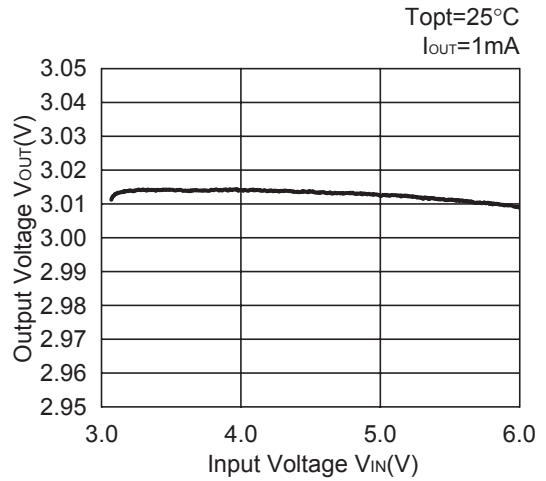

R1100D401C

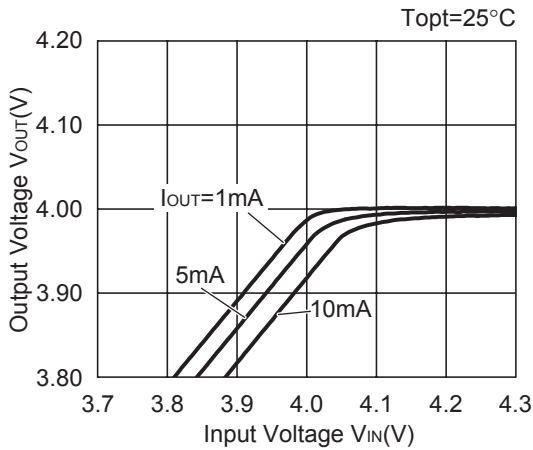

R1100D401C

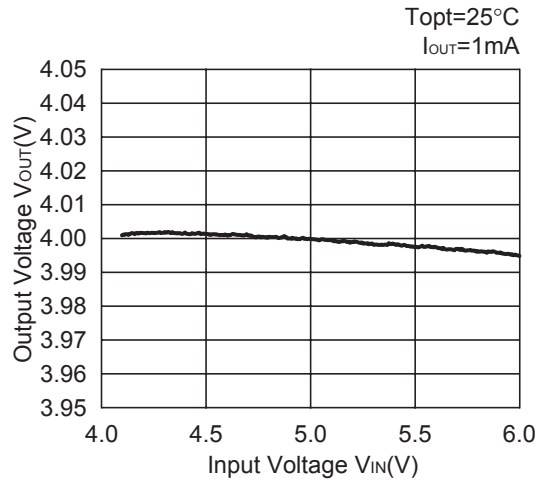

3) Dropout Voltage vs. Output Current

R1100D091C

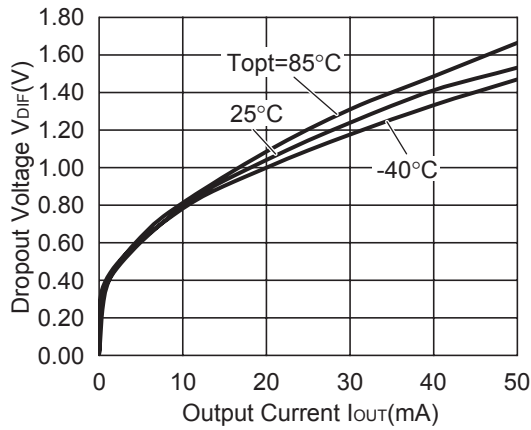

R1100D301C

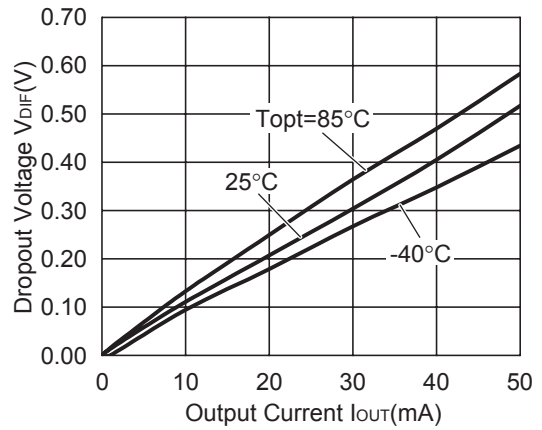

R1100D401C

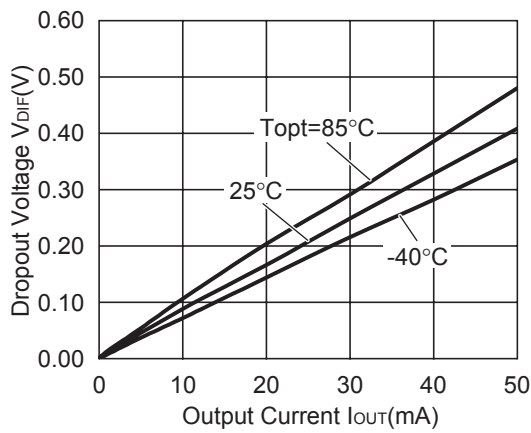

4) Output Voltage vs. Temperature

R1100D091C

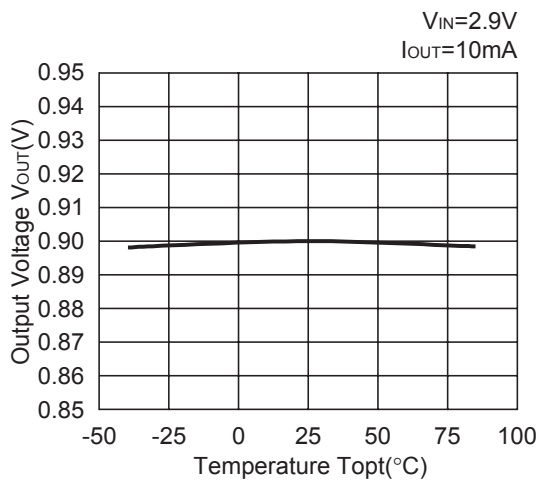

R1100D301C

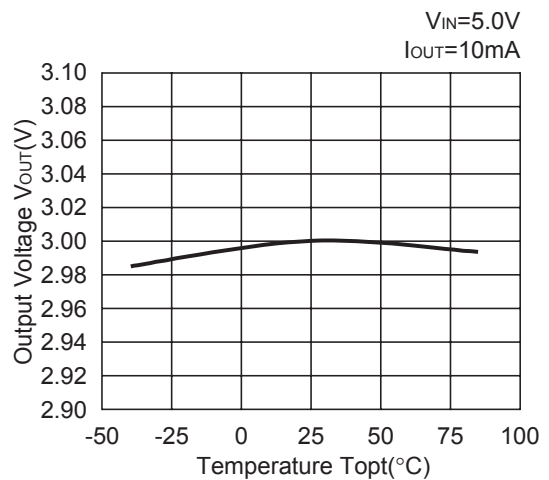

R1100D401C

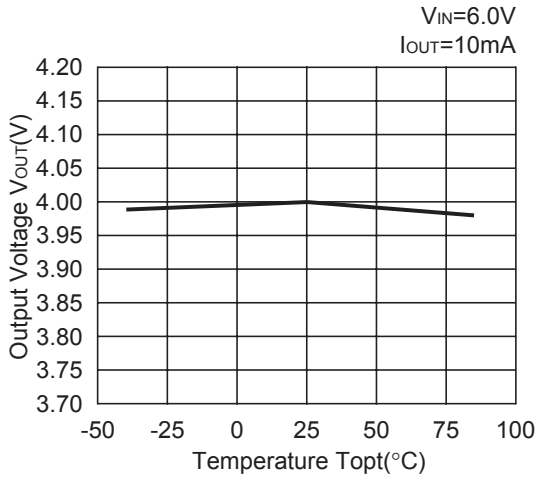

5) Supply Current vs. Input Voltage

R1100D091C

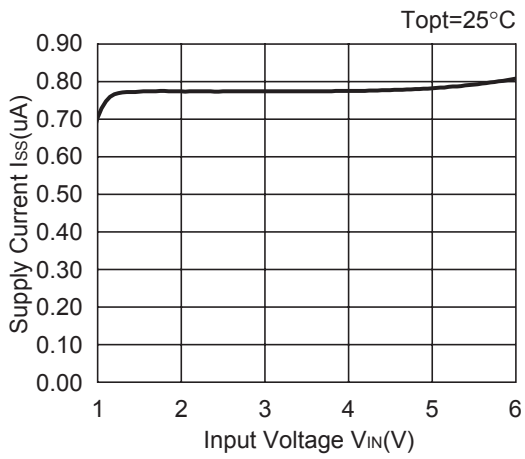

R1100D301C

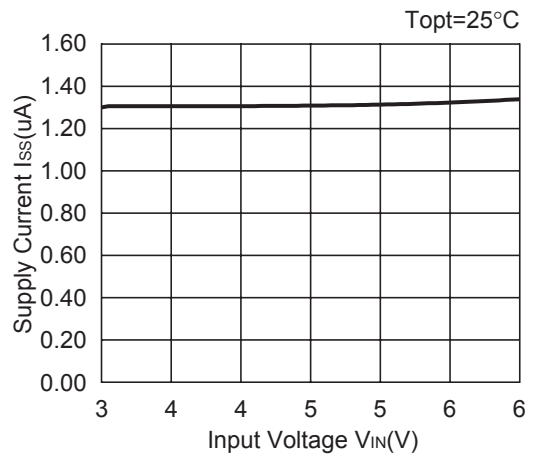

R1100D401C

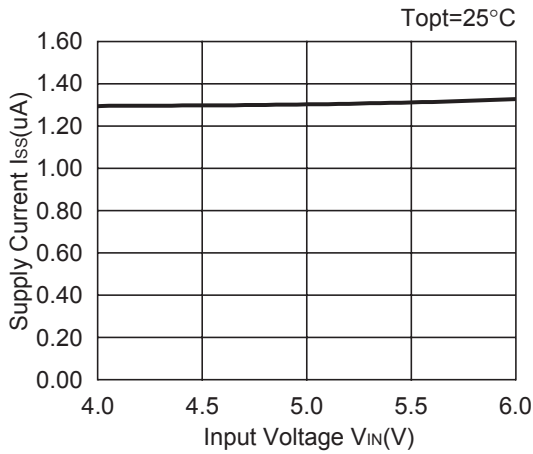

6) Supply Current vs. Temperature

R1100D091C

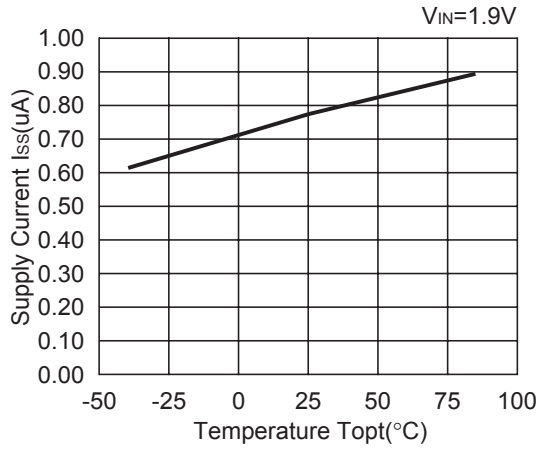

R1100D301C

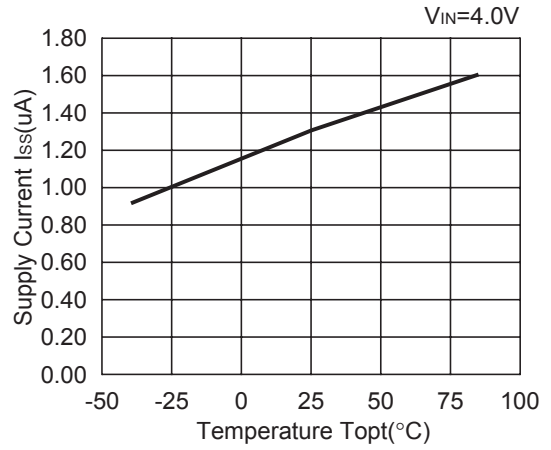

R1100D401C

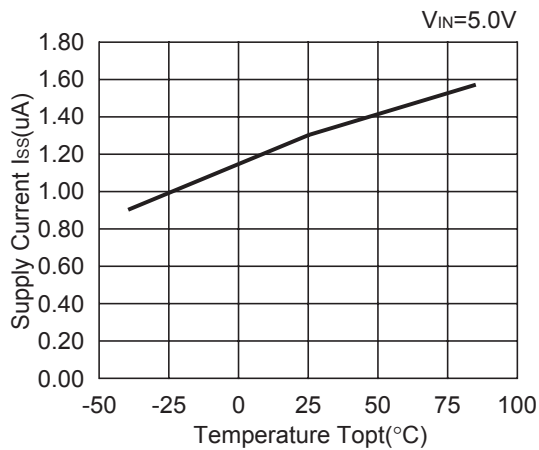

7) Dropout Voltage vs. Set Output Voltage

R1100Dxx1C

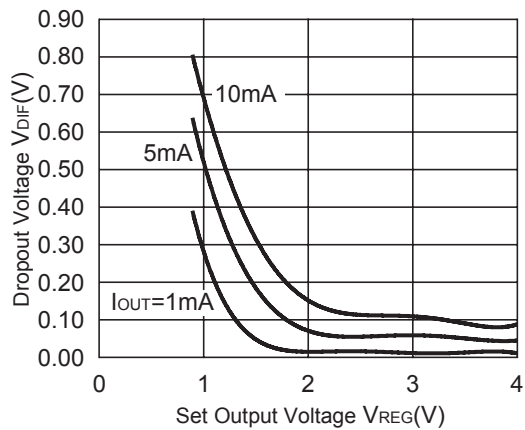

8) Line Transient Response

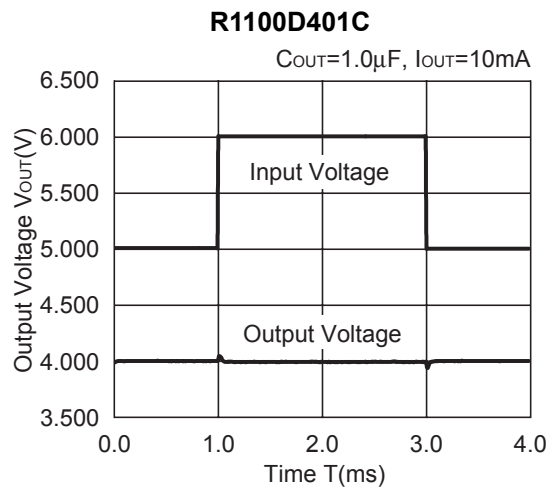
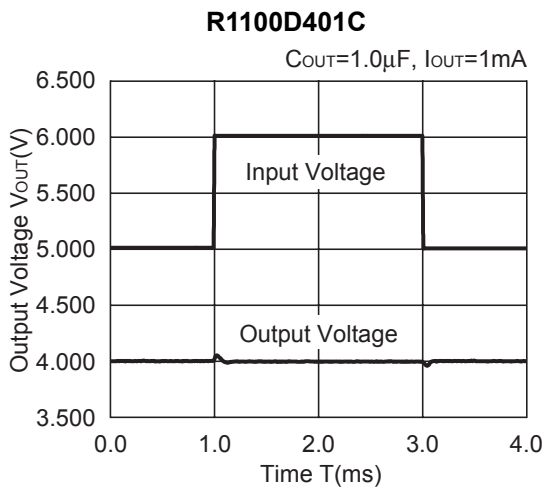
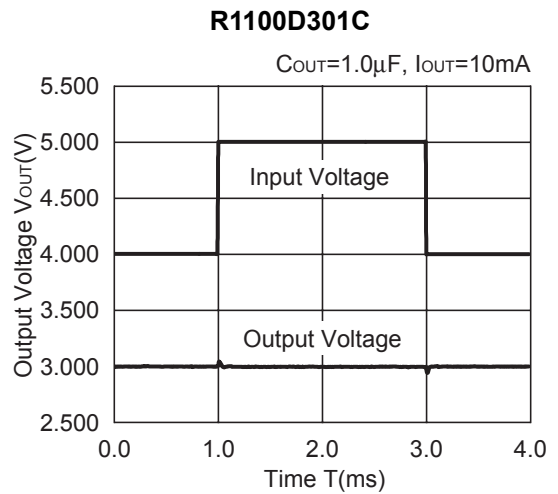
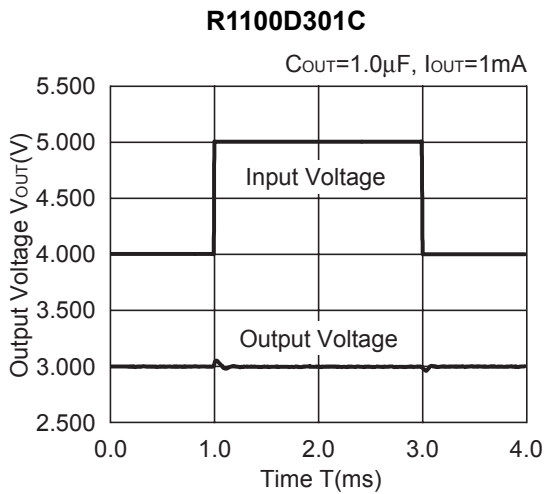
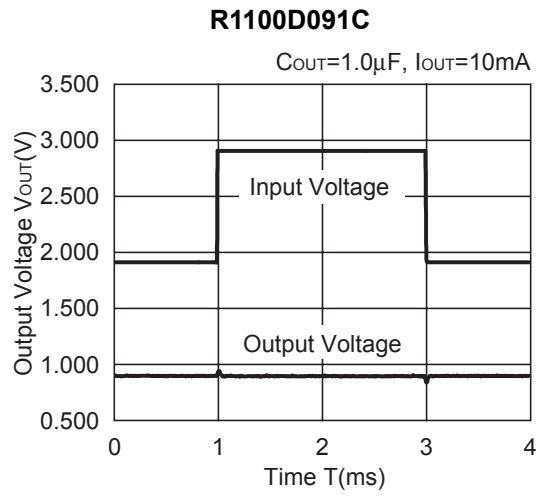
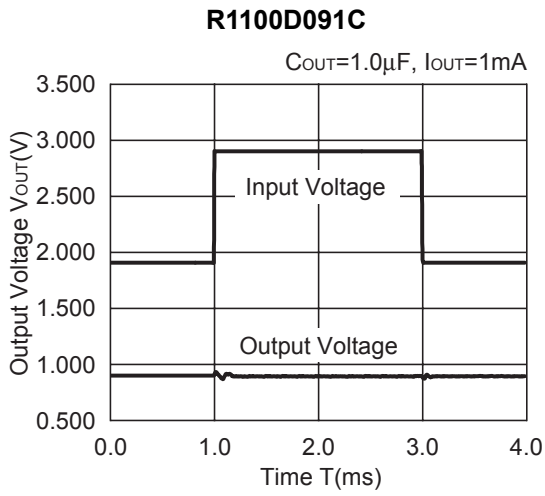

9) Load Transient Response

R1100D091C

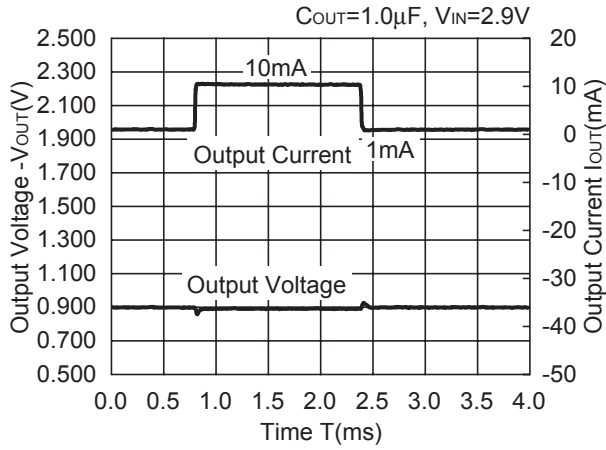

R1100D301C

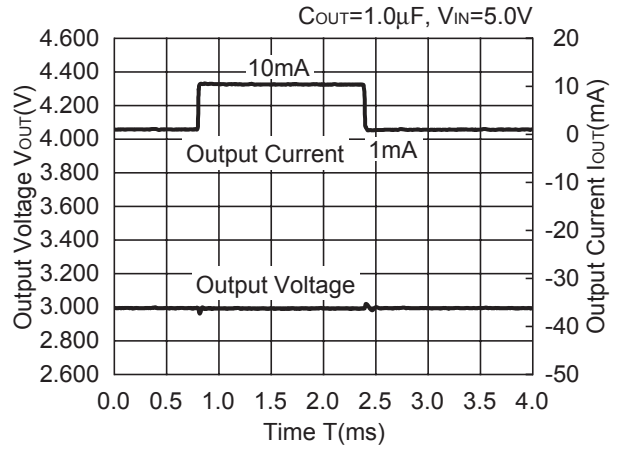

R1100D401C

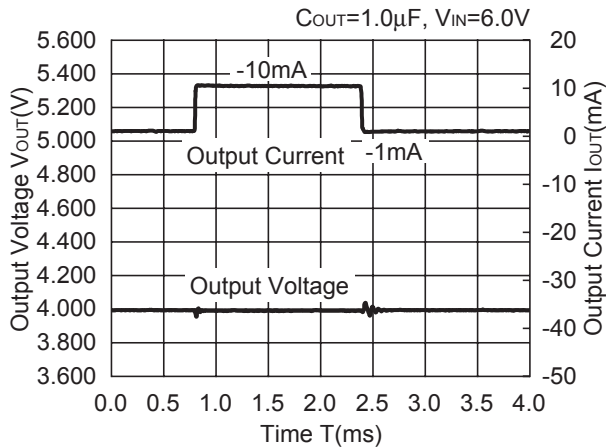

10) Ripple Rejection vs. Frequency

R1100D091C

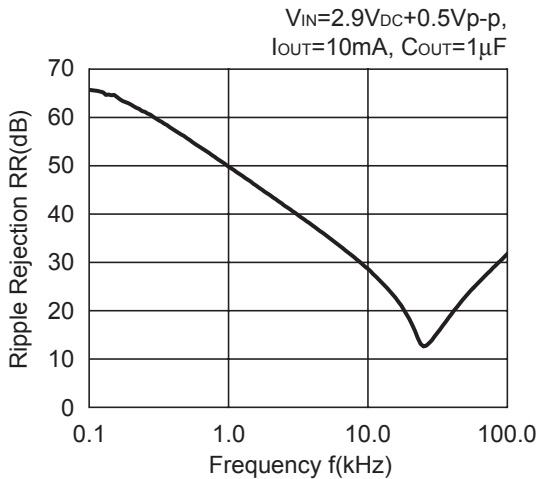

R1100D301C

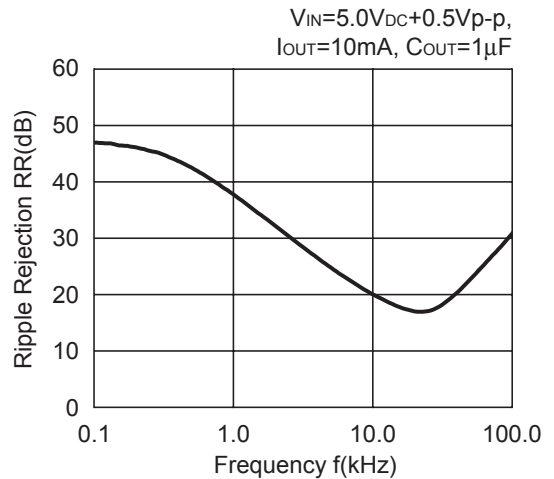

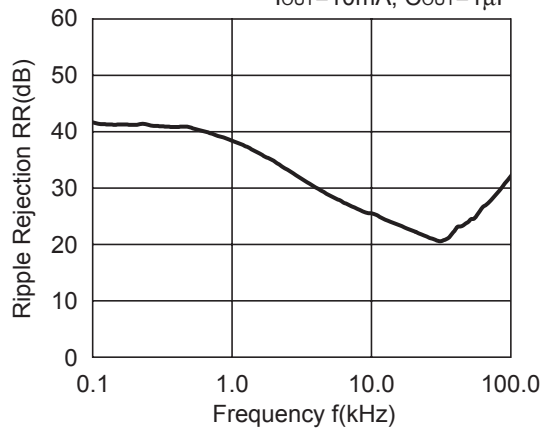
R1100D401C $V_{IN}=5.5V_{DC}+0.5V_{p-p}$,
 $I_{OUT}=10mA$, $C_{OUT}=1\mu F$ **TYPICAL APPLICATION**

In R1100D Series, a constant voltage can be obtained without using capacitors. However, when the wire connected V_{IN} is long, use a capacitor. Output noise can be reduced with using capacitor.

Insert capacitors with the capacitance of $0.1\mu F$ to $2.2\mu F$ between input/output pins and GND pin as close as possible.