

5A Low Dropout Positive Adjustable Regulator

FEATURES

- Dropout Voltage 1.3V at 5A Output Current.
- Fast Transient Response.
- Extremely Tight Line and Load Regulation.
- Current Limiting and Thermal Protection.
- Adjustable Output Voltage or Fixed 1.5V, 1.8V, 3.3V.
- Standard 3-Pin Power Packages.

APPLICATIONS

- Mother Board I/O Power Supplies.
- Microprocessor Power Supplies.
- High Current Regulator.
- Post Regulator for Switching Supply.

DESCRIPTION

The AIC1084 is a low dropout three terminal regulator with 5A output current capability. The output voltage is adjustable with the use of a resistor divider or fixed 3.3V. Dropout voltage is guaranteed to be at maximum of 1.4V with the maximum output current. Its low dropout voltage and fast transient response make it ideal for low voltage microprocessor applications. Current limit and thermal protection provide protection against any overload condition that would create excessive junction temperatures.

TYPICAL APPLICATION CIRCUIT

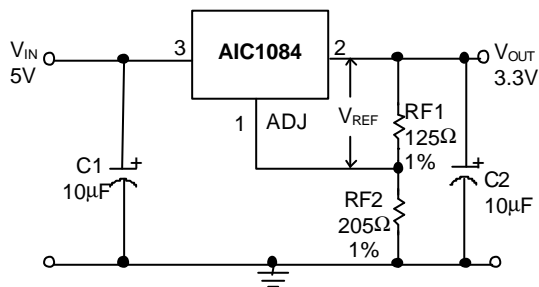

Adjustable Voltage Regulator

$$V_{REF} = V_{OUT} - V_{ADJ} = 1.25V \text{ (typ.)}$$

$$V_{OUT} = V_{REF} \times (1 + RF2/RF1) + I_{ADJ} \times RF2$$

$$I_{ADJ} = 55\mu A \text{ (typ.)}$$

- (1) C1 needed if device is far away from filter capacitors.
- (2) C2 required for stability.

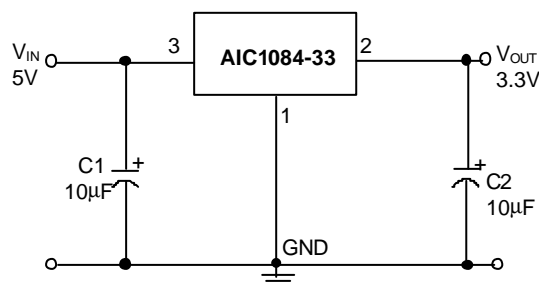

Fixed Voltage Regulator

ORDERING INFORMATION

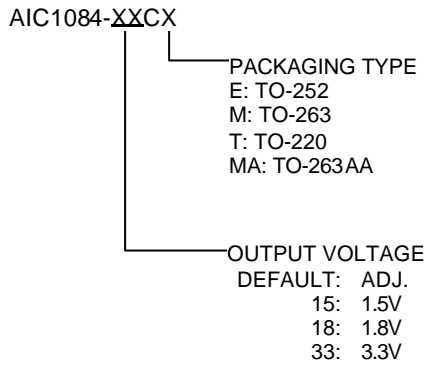

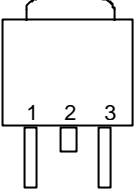
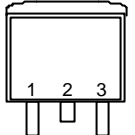
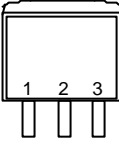
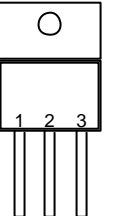
ORDER NUMBER	PIN CONFIGURATION
AIC1084CE (TO-252)	FRONT VIEW 1: ADJ (GND) 2: VOUT (TAB) 3: VIN 
AIC1084CM (TO-263)	FRONT VIEW 1: ADJ (GND) 2: VOUT (TAB) 3: VIN 
AIC1084CMA (TO-263AA)	FRONT VIEW 1: ADJ (GND) 2: VOUT (TAB) 3: VIN 
AIC1084CT (TO-220)	FRONT VIEW 1: ADJ (GND) 2: VOUT (TAB) 3: VIN 

ABSOLUTE MAXIMUM RATINGS

VIN pin to ADJ/GND pin	7V
Operating Junction Temperature Range	0°C~ 125°C
Storage Temperature Range	- 65°C ~ 150°C
Thermal Resistance Junction to Case	TO-252 15°C/W
	TO-263, TO263AA, TO-220..... 6°C /W
Thermal Resistance Junction to Ambient	TO-252 100°C/W
(Assume no ambient airflow, no heatsink)	TO-263 60°C /W
	TO-263AA 60°C /W
	TO-220 50°C /W
Lead Temperature (Soldering) 10 sec.	260°C

■ TEST CIRCUIT

Refer to TYPICAL APPLICATION CIRCUIT.

■ ELECTRICAL CHARACTERISTICS ($V_{IN}=5V$, $T_J=25^{\circ}C$, $I_O=10mA$, Unless otherwise specified)

PARAMETER	TEST CONDITIONS	MIN.	TYP.	MAX.	UNIT
Reference Voltage	AIC1084 (ADJ) $T_J=25^{\circ}C$	1.238	1.25	1.262	V
Output Voltage	AIC1084-15 $V_{IN}=5V$ AIC1084-18 $V_{IN}=5V$ AIC1084-33 $V_{IN}=5V$	1.48 1.78 3.26	1.50 1.80 3.30	1.52 1.82 3.34	V
Line Regulation	ADJ : $2.65V \leq V_{IN} \leq 7V$ $V_{OUT}=1.25V$ Fix : $V_{OUT}+1.4V \leq V_{IN} \leq 7V$ $T_J=25^{\circ}C$		0.015	0.2	%
Load Regulation	$10mA < I_O < 5A$ $T_J=25^{\circ}C$			0.6	%
Dropout Voltage	$\Delta V_{OUT}, \Delta V_{REF}=1\%$ $10mA \leq I_O \leq 5A$ $0^{\circ}C \leq T_J \leq 125^{\circ}C$		1.3	1.4	V
Current Limit	$0^{\circ}C \leq T_J \leq 125^{\circ}C$	5	6		A
Adjusted Pin Current	$2.65V \leq V_{IN} \leq 7V$		55	120	μA
Adjusted Pin Current Change (ΔI_{ADJ})	$2.65V \leq V_{IN} \leq 7V$ $0^{\circ}C \leq T_J \leq 125^{\circ}C$		0.2	5	μA
Temperature Stability	$I_O=0.5A$ $0^{\circ}C \leq T_J \leq 125^{\circ}C$		0.5		%
Minimum Load Current	$0^{\circ}C \leq T_J \leq 125^{\circ}C$		5	10	mA
RMS Output Noise (% of V_{OUT})	$10Hz \leq f \leq 10KHz$		0.003		%
Ripple Rejection Ratio	120Hz input ripple $C_{OUT}=25\mu F$ $(V_{IN}-V_{OUT})=3V$	60	72		dB

■ BLOCK DIAGRAM

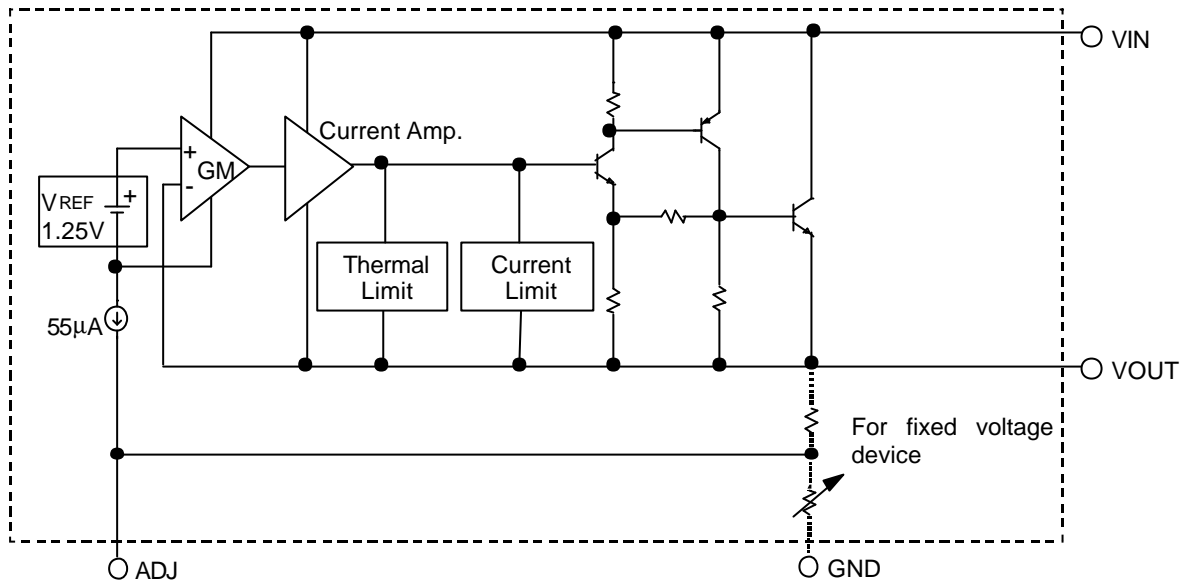

■ PIN DESCRIPTIONS

- ADJ PIN - Providing $V_{REF}=1.25V$ (typ.) for adjustable V_{OUT} . $V_{REF}=V_{OUT}-V_{ADJ}$ and $I_{ADJ}=55\mu A$ (typ.)
- GND PIN- Power ground.
- VOUT PIN - Adjustable output voltage.
- VIN PIN - Power Input.

■ TYPICAL PERFORMANCE CHARACTERISTICS

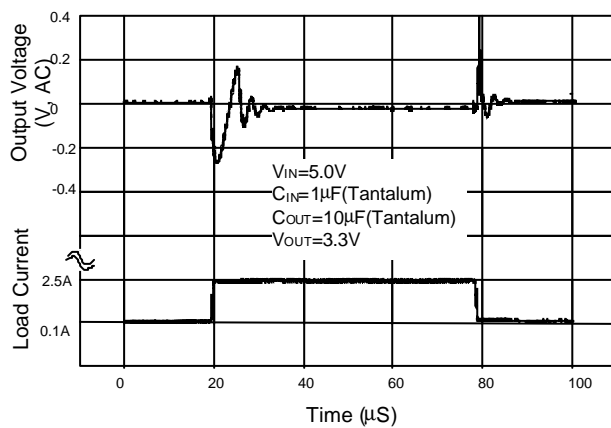

Fig. 1 Load Transient Response

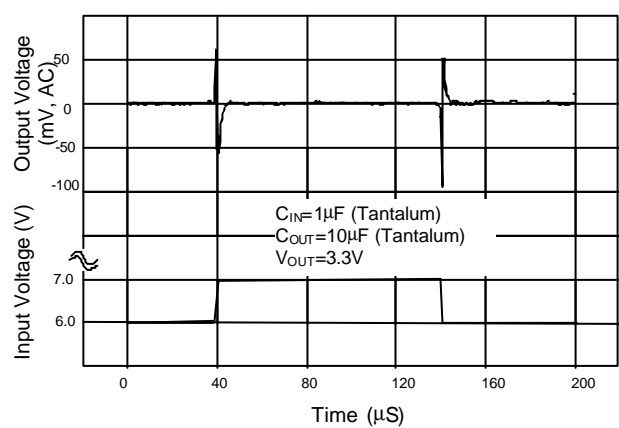

Fig. 2 Line Transient Response

TYPICAL PERFORMANCE CHARACTERISTICS (Continued)

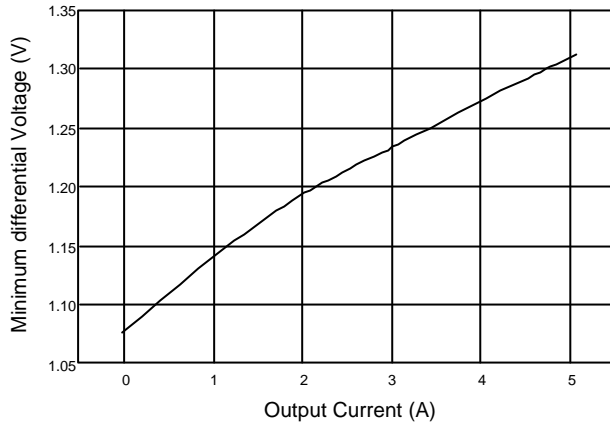

Fig. 3 Dropout Voltage ($V_{OUT}=3.3V$)

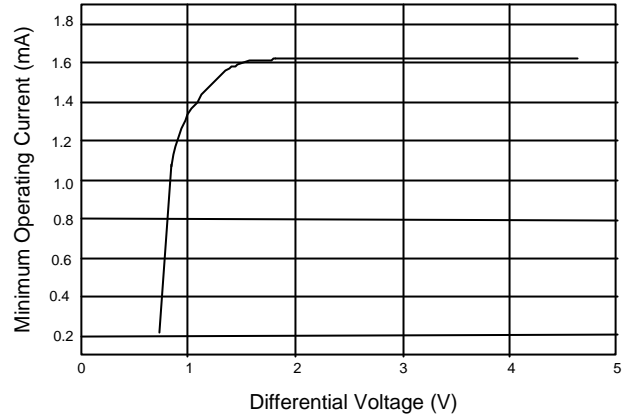

Fig. 4 Minimum Operating Current

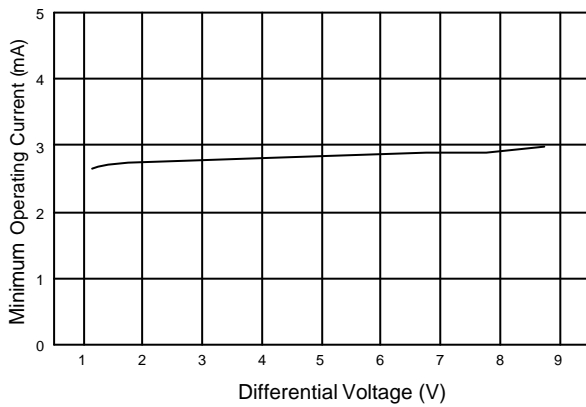

Fig. 5 Minimum Operating Current

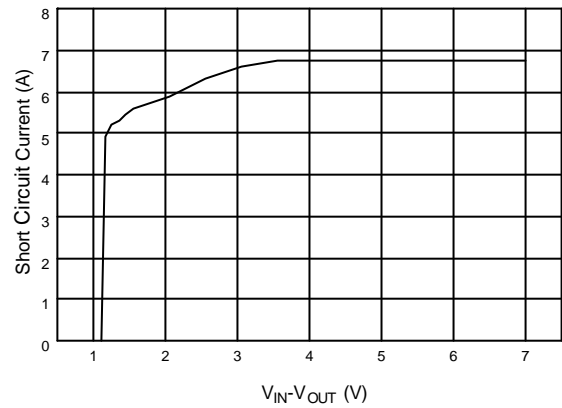

Fig. 6 AIC1084 (ADJ.) Short Circuit Current

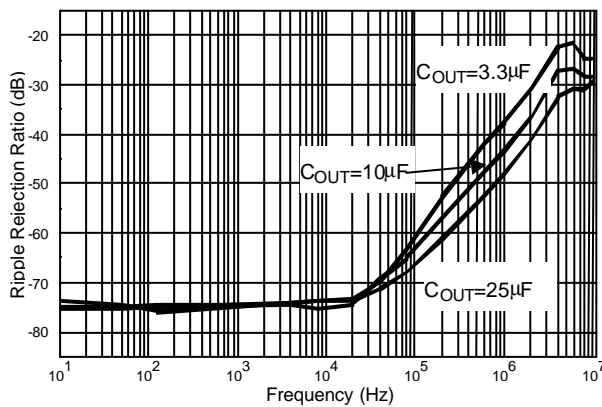
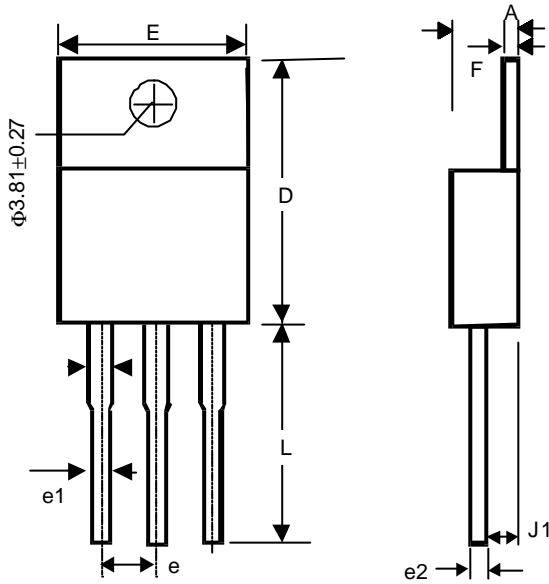

Fig. 7 AIC1084 (ADJ.) Ripple Rejection

■ PHYSICAL DIMENSIONS

- TO-220 (unit: mm)



SYMBOL	MIN	MAX
A	3.56	4.82
D	14.23	16.51
E	9.66	10.66
e	2.29	2.79
e1	0.50	1.15
e2	-	1.10
F	0.51	1.39
J1	2.04	2.92
L	12.70	14.73