

GaAs HIGH POWER T-1 3/4 PACKAGE INFRARED EMITTING DIODE

MIE-544A4

Description

The MIE-544A4 is an infrared emitting diode utilizing GaAs with AlGaAs window coating chip technology. It is molded in water clear plastic package.

Features

- High radiant power and high radiant intensity
- Suitable for DC and high pulse current operation
- Standard T-1 3/4 ($\phi 5\text{mm}$) package, radiant angle : 40°
- Peak wavelength $\lambda_p = 940\text{ nm}$
- Good spectral matching to si-photodetector

Package Dimensions

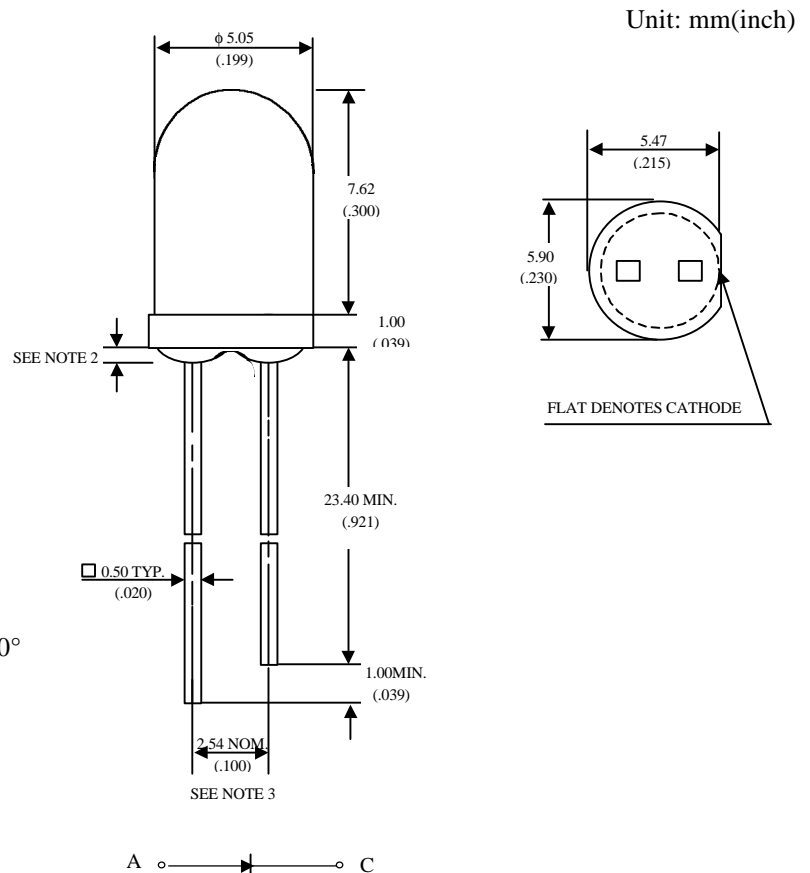

Notes :

1. Tolerance is $\pm 0.25\text{ mm}$ (.010") unless otherwise noted.
2. Protruded resin under flange is 1.5 mm (.059") max.
3. Lead spacing is measured where the leads emerge from the package.

Absolute Maximum Ratings

@ $T_A = 25^\circ\text{C}$

Parameter	Maximum Rating	Unit
Power Dissipation	100	mW
Peak Forward Current	1	A
Continuous Forward Current	50	mA
Reverse Voltage	5	V
Operating Temperature Range	-55°C to $+100^\circ\text{C}$	
Storage Temperature Range	-55°C to $+100^\circ\text{C}$	
Lead Soldering Temperature	260°C for 5 seconds	

UNI

Unity Opto Technology Co., Ltd.

11/17/2000

Optical-Electrical Characteristics

@ $T_A=25^{\circ}\text{C}$

Parameter	Test Conditions	Symbol	Min.	Typ .	Max.	Unit
Radiant Intensity	$I_F=20\text{mA}$	I_e	1.0	2.0		mW/sr
Forward Voltage	$I_F=50\text{mA}$	V_F		1.30	1.5	V
Reverse Current	$V_R=5\text{V}$	I_R			100	μA
Peak Wavelength	$I_F=20\text{mA}$	λ		940		nm
Spectral Bandwidth	$I_F=20\text{mA}$	$\Delta\lambda$		50		nm
View Angle	$I_F=20\text{mA}$	$2\theta_{1/2}$		40		deg .

Typical Optical-Electrical Characteristic Curves

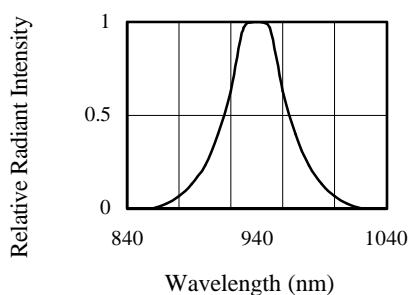
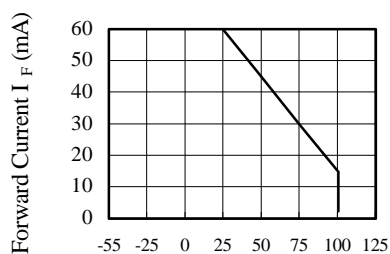

FIG.1 SPECTRAL DISTRIBUTION



Ambient Temperature $T_A(^{\circ}\text{C})$
FIG.2 FORWARD CURRENT VS. AMBIENT TEMPERATURE

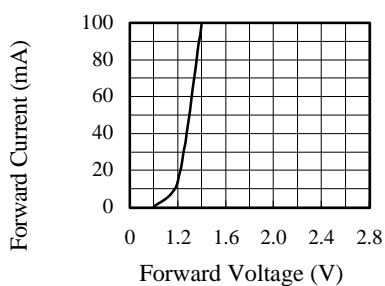
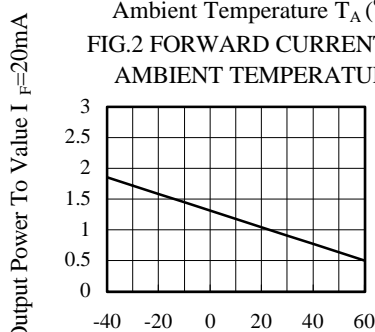

FIG.3 FORWARD CURRENT VS. FORWARD VOLTAGE



Ambient Temperature $T_A(^{\circ}\text{C})$
FIG.4 RELATIVE RADIANT INTENSITY VS. AMBIENT TEMPERATURE

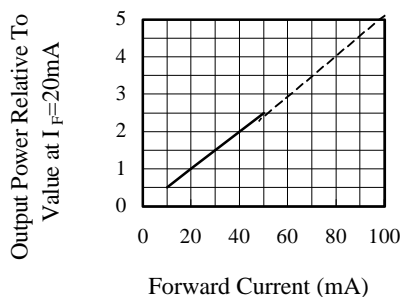

FIG.5 RELATIVE RADIANT INTENSITY VS. FORWARD CURRENT

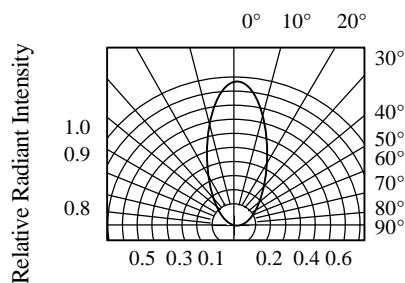

FIG.6 RADIATION DIAGRAM