

### Ultra Fast Recovery Rectifier Diodes

... Designed for use in switching power supplies, inverters and as free wheeling diodes. These state-of-the-art devices have the following features:

- \* High Surge Capacity
- \* Low Power Loss, High efficiency
- \* Glass Passivated chip junctions
- \* 150 °C Operating Junction Temperature
- \* Low Stored Charge Majority Carrier Conduction
- \* Low Forward Voltage , High Current Capability
- \* High-Switching Speed 50 & 75 Nanosecond Recovery Time
- \* Plastic Material used Carries Underwriters Laboratory Flammability Classification 94V-O

**ULTRA FAST  
RECTIFIERS**

**8 AMPERES  
700 -- 1000 VOLTS**

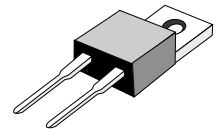

**TO-220A**

### MAXIMUM RATINGS

Characteristic	Symbol	U08A				Unit
		70	80	90	100	
Peak Repetitive Reverse Voltage Working Peak Reverse Voltage DC Blocking Voltage	$V_{RRM}$ $V_{RWM}$ $V_R$	700	800	900	1000	V
RMS Reverse Voltage	$V_{R(RMS)}$	490	560	630	700	V
Average Rectifier Forward Current	$I_{F(AV)}$	8.0				A
Non-Repetitive Peak Surge Current ( Surge applied at rate load conditions halfwave, single phase, 60Hz )	$I_{FSM}$	125				A
Operating and Storage Junction Temperature Range	$T_J, T_{stg}$	- 65 to + 150				°C

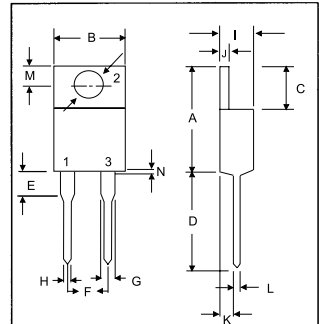

DIM	MILLIMETERS	
	MIN	MAX
A	14.68	15.32
B	9.78	10.42
C	6.01	6.52
D	13.06	14.62
E	3.57	4.07
F	4.83	5.33
G	1.12	1.36
H	0.72	0.96
I	4.22	4.98
J	1.14	1.36
K	2.20	2.97
L	0.33	0.55
M	2.48	2.98
N	--	1.00
O	3.70	3.90

### ELECTRICAL CHARACTERISTICS

Characteristic	Symbol	U08A				Unit
		70	80	90	100	
Maximum Instantaneous Forward Voltage ( $I_F=8.0$ Amp, $T_C=25$ °C) ( $I_F=8.0$ Amp, $T_C=100$ °C)	$V_F$	1.75 1.65				V
Maximum Instantaneous Reverse Current ( Rated DC Voltage, $T_C=25$ °C) ( Rated DC Voltage, $T_C=100$ °C)	$I_R$	10 500				uA
Reverse Recovery Time ( $I_F=0.5$ A, $I_R=1.0$ A , $I_{rr}=0.25$ A )	$T_{rr}$	50		75		ns
Typical Junction Capacitance ( Reverse Voltage of 4 volts & f=1 MHz)	$C_P$	40				pF

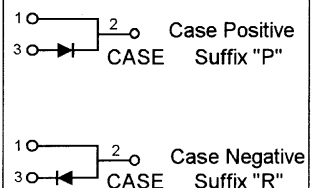

# U08A70 Thru U08A100

FIG-1 TYPICAL FORWARD CHARACTERISTICS

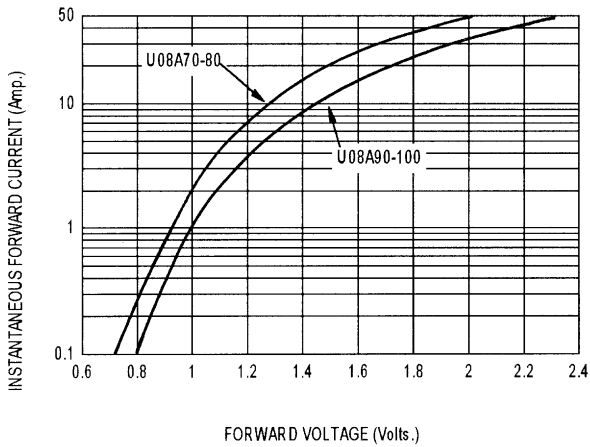

FIG-2 TYPICAL REVERSE CHARACTERISTICS

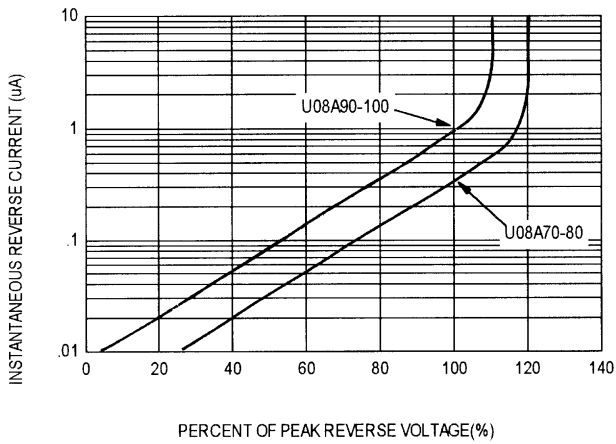

FIG-3 FORWARD CURRENT DERATING CURVE

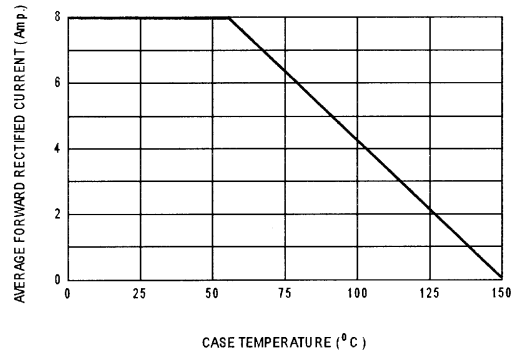

FIG-4 TYPICAL JUNCTION CAPACITANCE

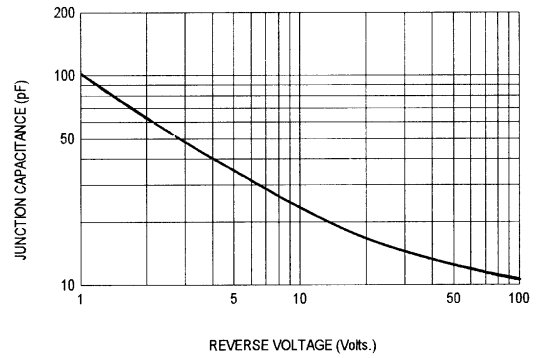
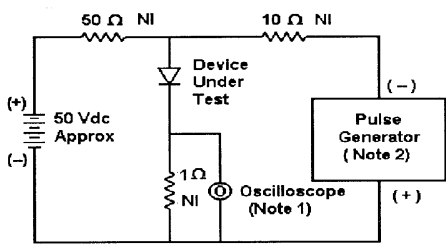
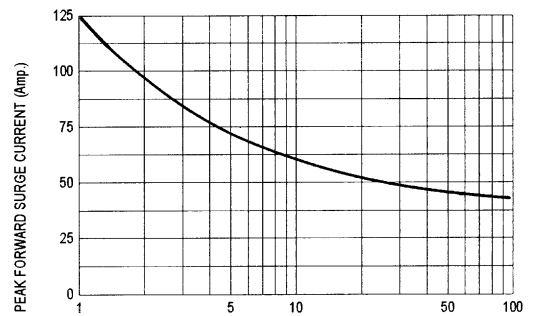
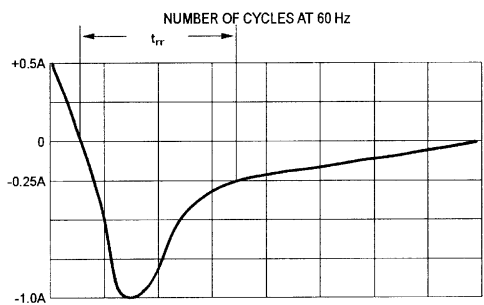

FIG-5 PEAK FORWARD SURGE CURRENT



- Notes:  
 1. Rise Time = 7 ns max. Input Impedance = 1 M Ω, 22 pF  
 2. Rise Time = 10 ns max. Input Impedance = 50 Ω



Set time base for 10/20 ns/div

Fig-6 Reverse Recovery Time Characteristic and Test Circuit Diagram