

Ultra Rapid Semiconductor Protection Fuse European Square Body Type Fuses













French Standard End Contacts
Voltage Ratings 450V - 690V
Current Ratings 40A – 2500A
aR Characteristics
Sizes 0, 1, 2, 3















Key Features:

- ❖ Extremely high interrupting rating fuses for the protection of power semiconductors in accordance with IEC Standard 60269.1 and 4.
- ❖ Exceptionally low I^2t , power losses
- ❖ Highly reliable low voltage trip indicator system
- ❖ Non Magnetic construction
- ❖ Conform to UL, IEC, DIN and VDE standards
- ❖ Increased technical performance gives higher ratings and reduction in volume and weight
- ❖ All models available with integrated trip-indicator
- ❖ Microswitch system reference MS 3V 1-5















Main Characteristics:

Size	Voltage Rating U _N (V)	Ref:		Current rating I _N (A)	Pre-arcing I ² t @ 1 ms I ² t _p (10 ³ kA ² s)	Total Clearing I ² t @ U _N (10 ³ kA ² s)	Watt Losses		Tested Interrupting rating
							0.8I _N	I _N	
0	690V	069UR0S0040B		40	0.11	0.68	3	5.5	200kA @690V
		069UR0S0050B		50	0.12	0.68	4.5	9	
		069UR0S0063B		63	0.20	1.1	7.5	14	
		069UR0S0080B		80	0.33	1.75	9.5	19	
		069UR0S0100B		100	0.47	2.5	13	26	
		069UR0S0125B		125	0.85	4.5	15	30	
		069UR0S0160B		160	1.6	8.5	18.5	37	
		069UR0S0200B		200	3	15.5	21.5	43	
		069UR0S0250B		250	5.8	30	25	50	
		069UR0S0315B		315	12	62	22.5	55	
		069UR0S0350B		350	15.5	80	30	60	
		069UR0S0400B		400	23	120	32.5	65	
		069UR0S0450B		450	26	150	44	88	
		069UR0S0500B		500	41	240	44	88	
		069UR0S0550B		550	52	300	45	90	

















Notes: Minimum operating voltage for integrated trip indicator = 20V
 Microswitch Reference : MS 3V 1-5

Size	Voltage Rating U _N (V)	Ref:		Current rating I _N (A)	Pre-arcing I ² t @ 1 ms I ² t _p (10 ³ kA ² s)	Total Clearing I ² t @ U _N (10 ³ kA ² s)	Watt Losses		Tested Interrupting rating
							0.8I _N	I _N	
1	690V	069UR1S0160B		160	1.3	7.7	27.5	35	200kA @690V
		069UR1S0200B		200	2.6	13.5	22.5	45	
		069UR1S0250B		250	4.7	25	25.5	52	
		069UR1S0315B		315	7.5	40	32.5	65	
		069UR1S0350B		350	10.5	55	33.5	67	
		069UR1S0400B		400	19	100	34	68	
		069UR1S0450B		450	26.5	140	35	70	
		069UR1S0500B		500	37	195	36	72	
		069UR1S0550B		550	52	280	37.5	75	
		069UR1S0630B		630	75	390	42.5	85	
		069UR1S0700B		700	95	490	85	95	
		069UR1S0800B		800	140	800	52.5	105	

Notes: Minimum operating voltage for integrated trip indicator = 20V
 Microswitch Reference : MS 3V 1-5

Size	Voltage Rating U_N (V)	Ref:		Current rating I_N (A)	Pre-arcing $I^2t @ 1 \text{ ms}$ $I^2t_p(10^3 \text{ kA}^2\text{s})$	Total Clearing $I^2t @ U_N$ $(10^3 \text{ kA}^2\text{s})$	Watt Losses		Tested Interrupting rating
							$0.8I_N$	I_N	
2	690V	069UR2S0400B		400	15	80	32.5	75	200kA @ 690V
		069UR2S0450B		450	20	115	40	80	
		069UR2S0500B		500	28	145	45	90	
		069UR2S0550B		550	37	195	47.5	95	
		069UR2S0630B		630	54	280	52.5	105	
		069UR2S0700B		700	76	400	-	110	
		069UR2S0800B		800	115	600	60	120	
	690V +6%	069UR2S0900B		900	170	900	62.5	125	200kA @ 690V
		069UR2S1000B		1000	240	1250	77.5	135	
	600V	060UR2S1100B		1100	270	1670	82.5	165	160kA @ 600V
	550V	055UR2S1250B		1250	410	2400	90	180	150kA @ 550V
	500V	050UR2S1400B		1400	555	3400	95	190	130kA @ 500V
		050UR2S1600B		1600	870	5300	97.5	195	
	450V	045UR2S1800B		1800	1050	3700	115	230	110kA @ 450V

Notes: Minimum operating voltage for integrated trip indicator = 20V Microswitch Reference : MS 3V 1-5

Size	Voltage Rating U_N (V)	Ref:		Current rating I_N (A)	Pre-arcing $I^2t @ 1 \text{ ms}$ $I^2t_p(10^3 \text{ kA}^2\text{s})$	Total Clearing $I^2t @ U_N$ $(10^3 \text{ kA}^2\text{s})$	Watt Losses		Tested Interrupting rating
							$0.8I_N$	I_N	
3	690V	069UR3S0500B		500	19	100	52.5	105	200kA @ 690V
		069UR3S0550B		550	27	140	55	110	
		069UR3S0630B		630	40	210	60	120	
		069UR3S0700B		700	55	300	-	125	
		069UR3S0800B		800	95	490	65	130	
		069UR3S0900B		900	135	700	67.5	135	
		069UR3S1000B		1000	170	900	77.5	155	
	690V +6%	069UR3S1100B		1100	240	1260	80	160	200kA @ 690V
		069UR3S1250B		1250	350	1850	90	180	
	660V	069UR3S1400B		1400	480	2500	100	200	260kA @ 600V
		069UR3S1500B		1500	500	3000	115	230	
		069UR3S1600B		1600	555	3300	120	240	
	550V	055UR3S1800B		1800	720	4450	130	260	150kA @ 550V
	500V	050UR3S2000B		2000	950	5600	145	290	130kA @ 500V
	500V	050UR3S2250B		2250	1250	7600	165	330	130kA @ 500V
		050UR3S2500B		2500	1870	10500	165	330	
	450V	045UR3S2500B		2500	1870	6540	165	330	110kA @ 450V

Notes: Minimum operating voltage for integrated trip indicator = 20V Microswitch Reference : MS 3V 1-5

Electrical Characteristics:

Times vs current characteristics

The following curves indicate the pre-arcing time for each rated current as a function of RMS value of pre-arcing current I:

- Tolerances on this current $\pm 8\%$
- Beyond 30 sec or 10 sec, small overloads must be eliminated by another device.

Curve CC' represents the maximum times taken by the associated device to clear small overloads; only its horizontal line is represented.

Its oblique line must be plotted according to sketch in top right corner:

- The intersection of the fuse and CC' curves indicates the minimum breaking current I_{pm} of the fuse.

Size 0

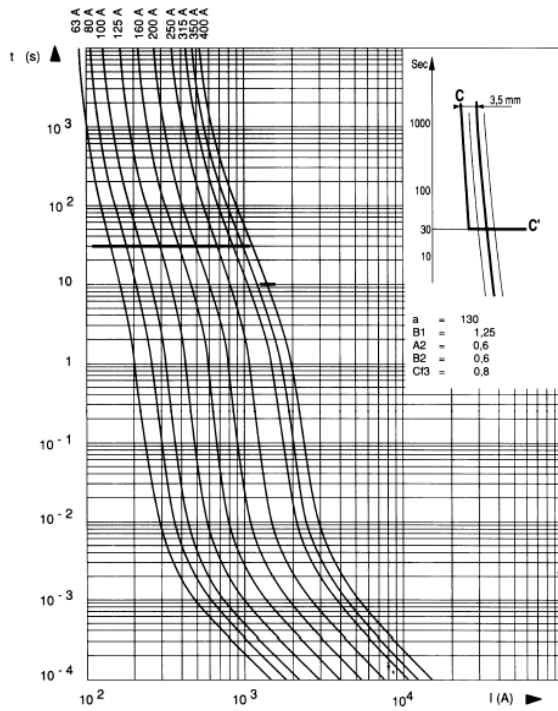

Size 1

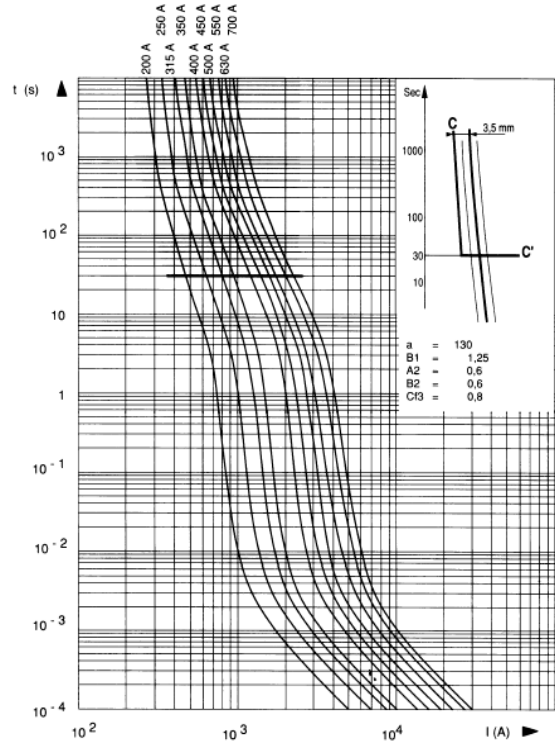

Size 2

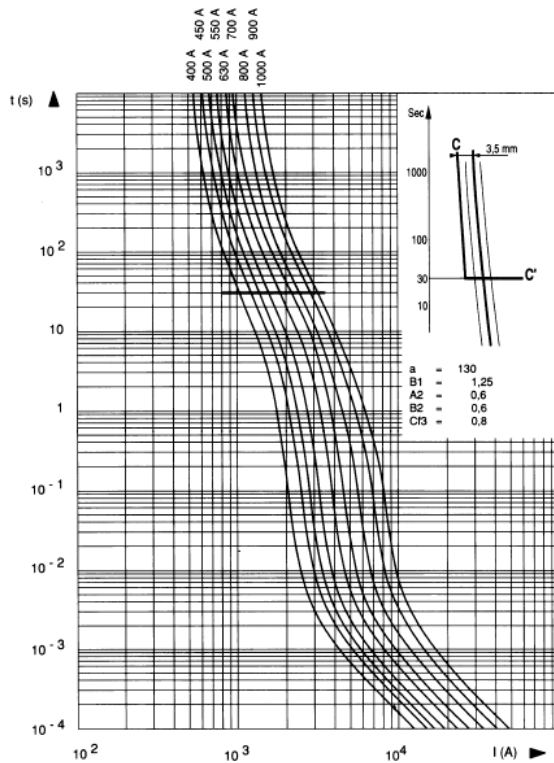

Size 3

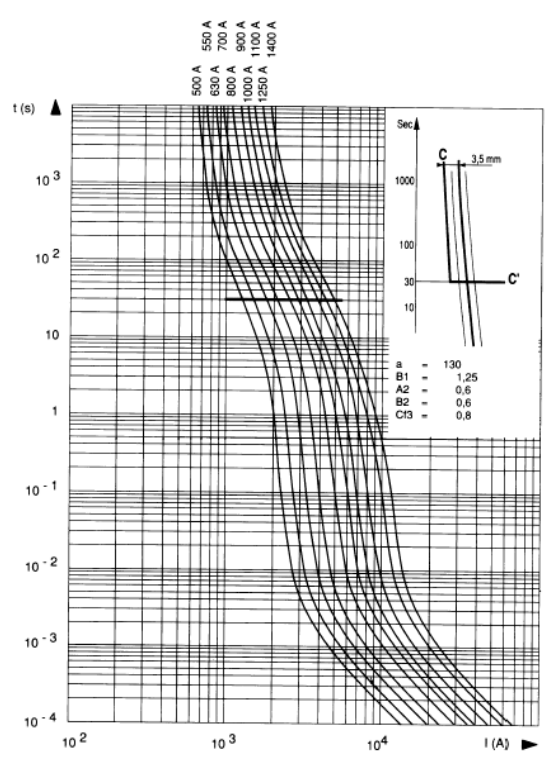

Total clearing I²T:

The horizontal curves given below indicated the maximum values of total operating I²t (I²t_t) as a function of prospective current I_p @ 660V, cosφ = 0.15. Oblique lines indicate the corresponding total operating time T_t, with pre-arcing time in brackets.

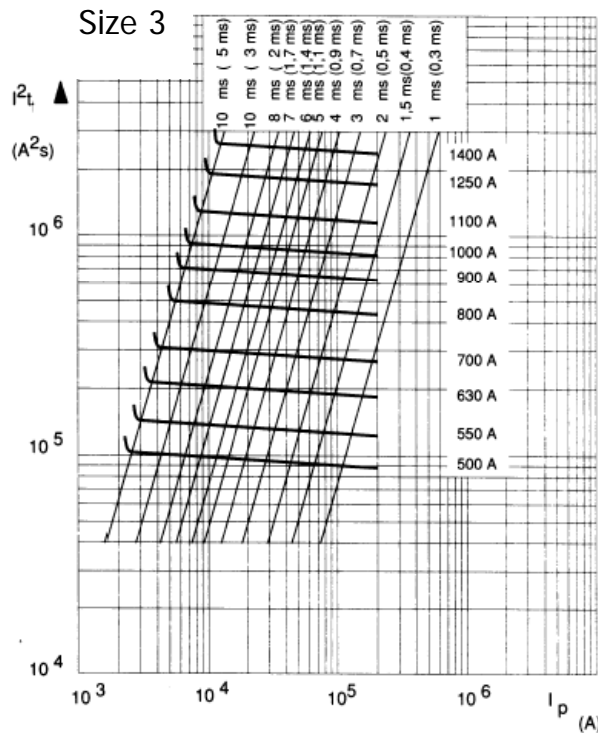
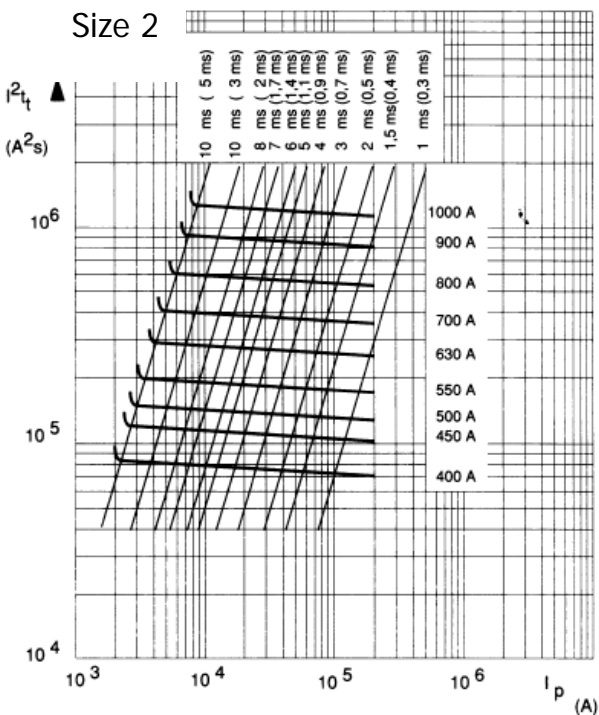
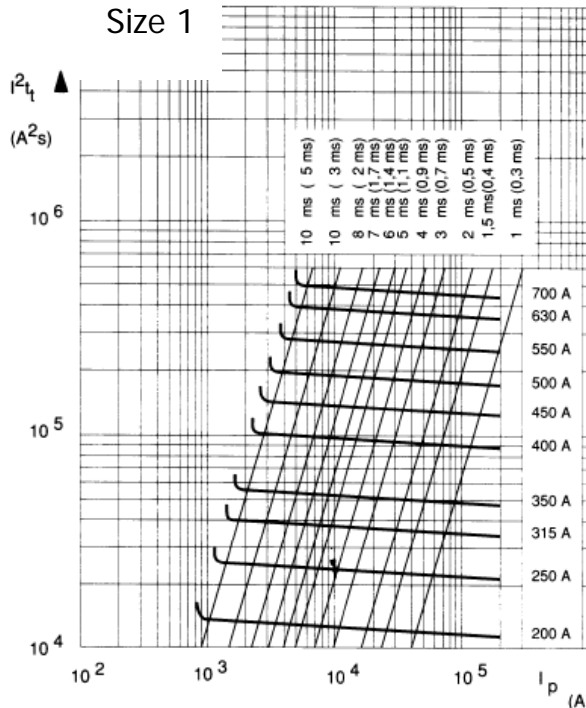
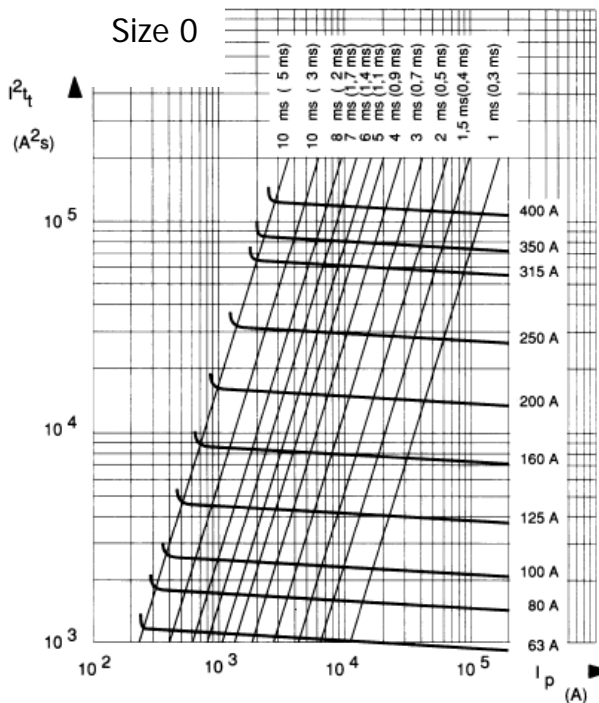

Cut off Characteristics:

The curves below indicate, for each rated current, the peak value I_c that the current may reach as a function of the prospective fault current I_p .

Size 0

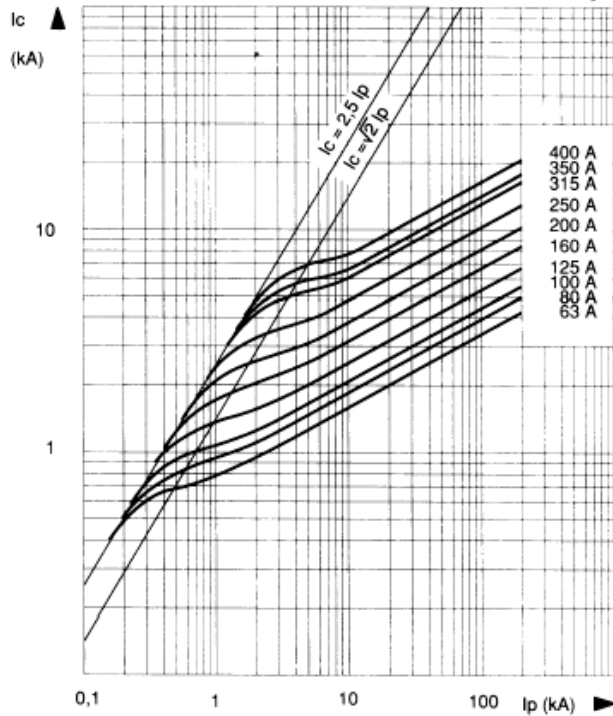

Size 1

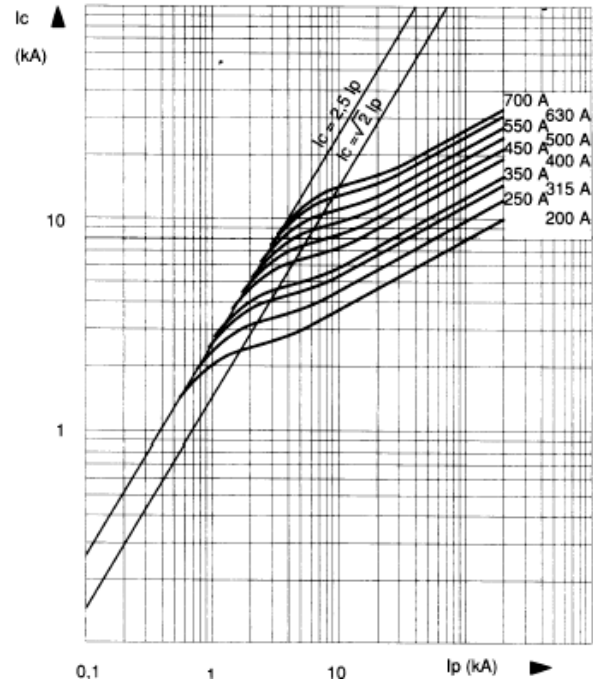

Size 2

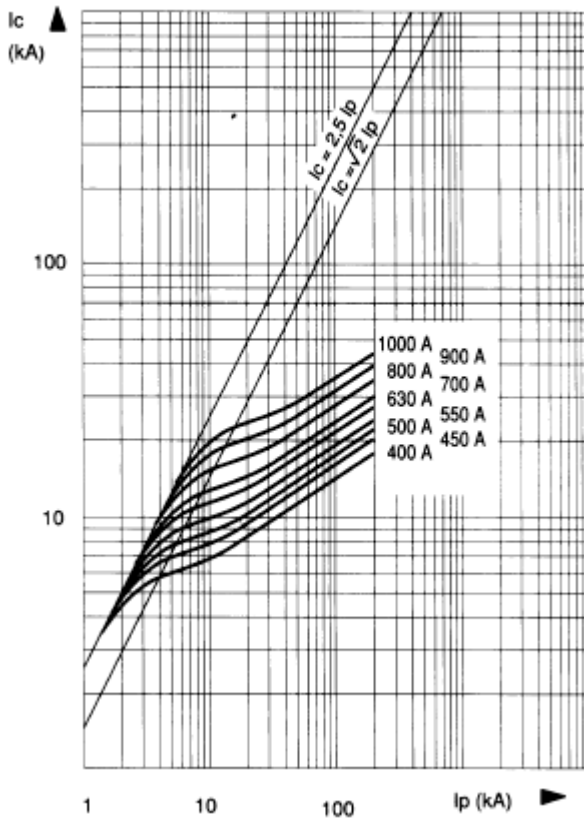

Size 3

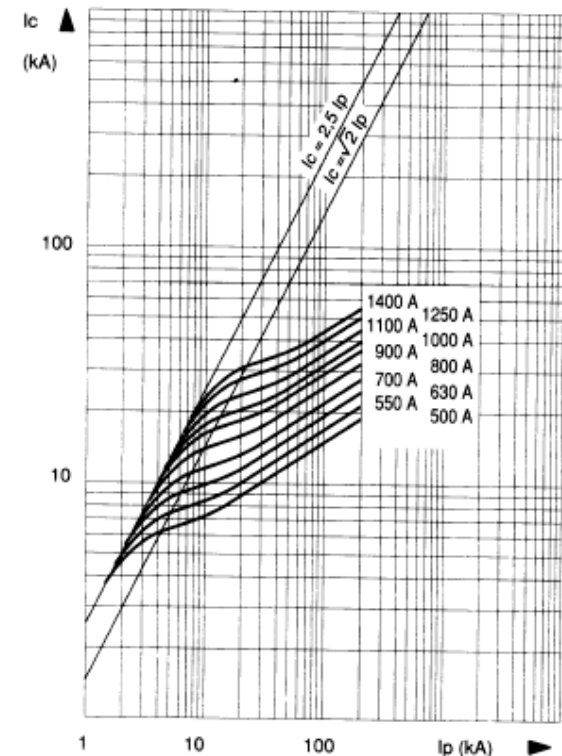

Correction Factor, Peak Arc Voltage and

I²t Multiplier Coefficient

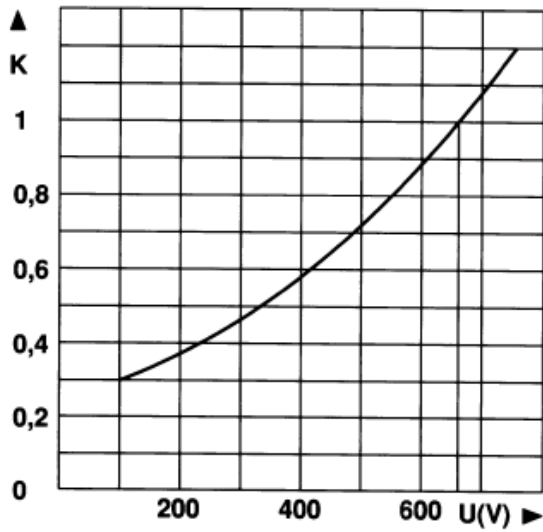

The above Mean curve shows variation of total clearing time (I²t_i) and total operating time T_i in accordance with working voltage U.

Peak Arc Voltage

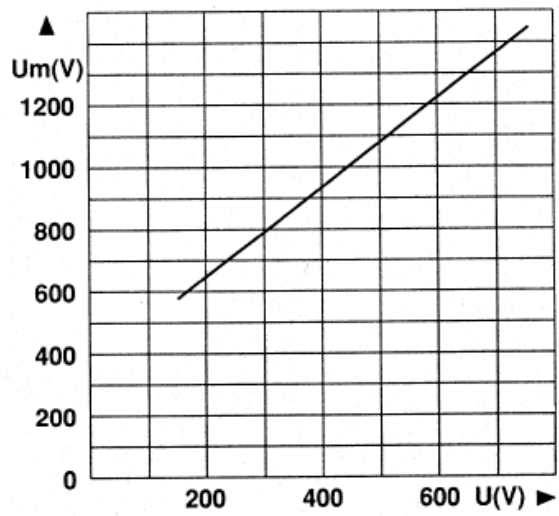

Curve indicating peak arc voltage Um which may appear across fuse terminals as a function of working voltage U @ cos φ = 0.15.

Dissipated Power

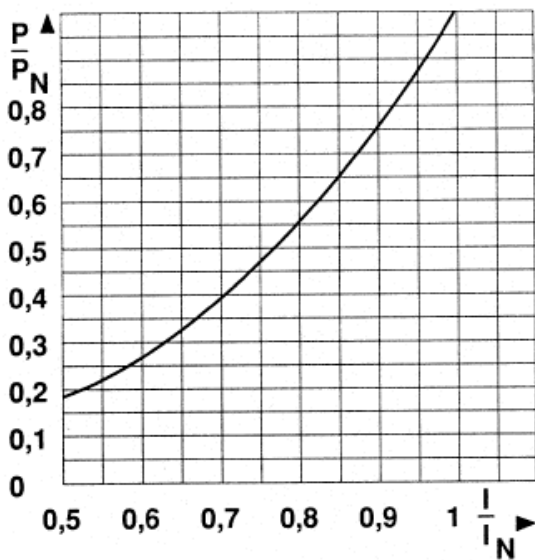

Curve enabling calculation of dissipated power P by a fuse rated I_N, as a function of the RMS current I, in multiples of I_N in a steady state.

Outline Drawing & Ordering Information:

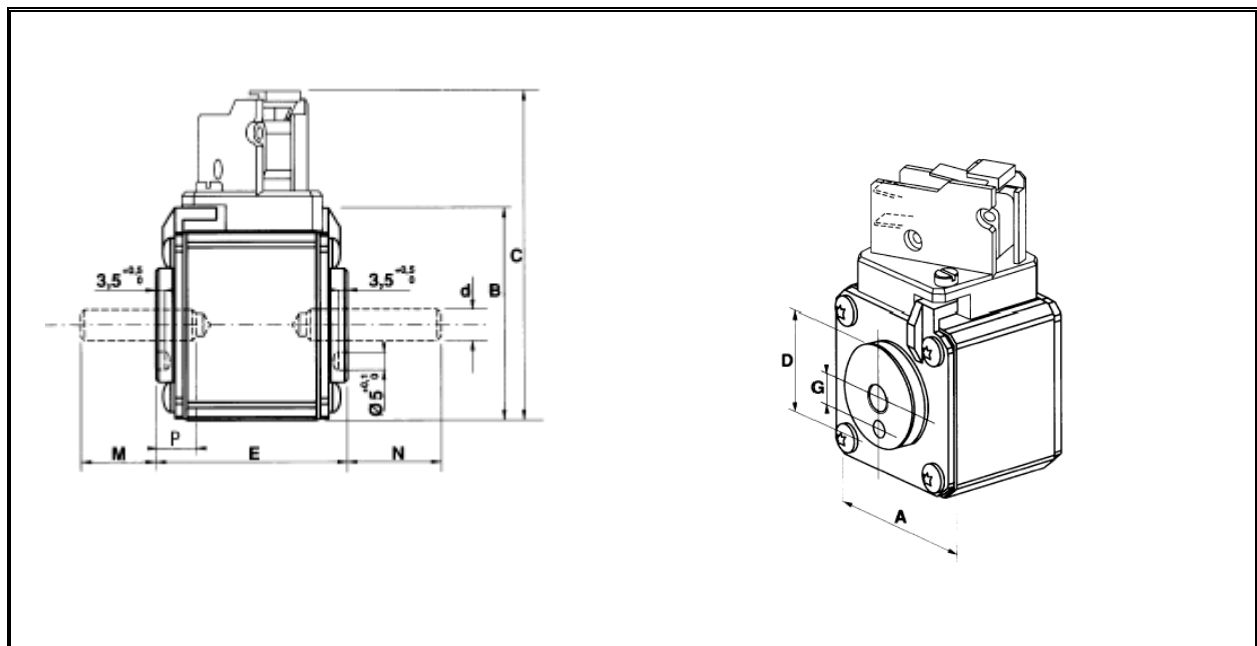

Dimensions (mm)

Size	A	B	C	D	M	N	E	d	G	P	Weight
0	40	46.5	82	26	22	27	50.6	M8	9	6	245g
1	51	56.5	91	30	19	24	50.6	M8	9	9	370g
2	60	65.5	100	38 (* 42)	19	39	50.6	M10	15	9	510g(600g)
3	74.5	79.5	114	46 (* 52)	24	39	50.6	M12	15	9	790g(910g)

ORDERING INFORMATION

(Please quote code as below)

Voltage Rating (V)	Type	Size	Fixing	Current Rating (A)	Indicator
450 – 690	UR	0, 1, 2, 3	S	0040 – 2500	B

Order code: e.g. **069UR2S0630B** = 690V, French End Contact, Size 2, DIN110, 630A, with button indicator

IXYS Semiconductor GmbH
 Edisonstraße 15
 D-68623 Lampertheim
 Tel: +49 6206 503-0
 Fax: +49 6206 503-627
 E-mail: marcom@ixys.de

WESTCODE
 An IXYS Company

Westcode Semiconductors Ltd
 Langley Park Way Langley Park
 Chippenham Wiltshire SN15 1GE
 Tel: +44 (0)1249 444524
 Fax: +44 (0)1249 659448
 E-mail: WSL.sales@westcode.com

IXYS Corporation
 3540 Bassett Street
 Santa Clara CA 95054 USA
 Tel: +1 (408) 982 0700
 Fax: +1 (408) 496 0670
 E-mail: sales@ixys.net

www.westcode.com

www.ixys.net

Westcode Semiconductors Inc
 3270 Cherry Avenue
 Long Beach CA 90807 USA
 Tel: +1 (562) 595 6971
 Fax: +1 (562) 595 8182
 E-mail: WSI.sales@westcode.com

The information contained herein is confidential and is protected by Copyright. The information may not be used or disclosed except with the written permission of and in the manner permitted by the proprietors Westcode Semiconductors Ltd.

© Westcode Semiconductors Ltd.

In the interest of product improvement, Westcode reserves the right to change specifications at any time without prior notice.