

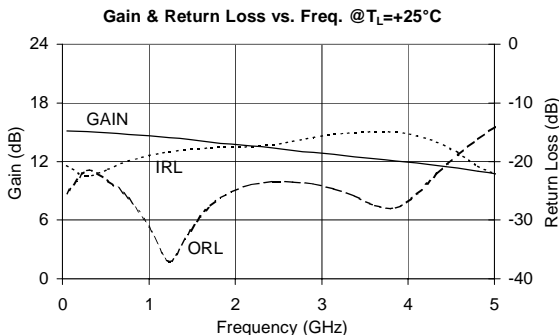

## Product Description

Sirenza Microdevices' SGA-2263 is a high performance SiGe HBT MMIC Amplifier. A Darlington configuration featuring 1 micron emitters provides high  $F_T$  and excellent thermal performance. The heterojunction increases breakdown voltage and minimizes leakage current between junctions. Cancellation of emitter junction non-linearities results in higher suppression of intermodulation products. At 850 Mhz and 20mA, the SGA-2263 typically provides +20.2 dBm output IP3, 14.7 dB of gain, and +7.5 dBm of 1dB compressed power using a single positive voltage supply. Only 2 DC-blocking capacitors, a bias resistor and an optional RF choke are required for operation.



## SGA-2263

### DC-5000 MHz, Cascadable SiGe HBT MMIC Amplifier



### Product Features

- High Gain : 13.8 dB at 1950 MHz
- Cascadable 50 Ohm
- Patented SiGe Technology
- Operates From Single Supply
- Low Thermal Resistance Package

### Applications

- PA Driver Amplifier
- Cellular, PCS, GSM, UMTS
- IF Amplifier
- Wireless Data, Satellite

Symbol	Parameter	Units	Frequency	Min.	Typ.	Max.
G	Small Signal Gain	dB	850 MHz 1950 MHz 2400 MHz	13.2	14.7 13.5 13.2	16.2
$P_{1dB}$	Output Power at 1dB Compression	dBm	850 MHz 1950 MHz		7.5 6.1	
$OIP_3$	Output Third Order Intercept Point	dBm	850 MHz 1950 MHz		20.2 18.0	
Bandwidth	Determined by Return Loss (>10dB)	MHz			5000	
IRL	Input Return Loss	dB	1950 MHz		17.6	
ORL	Output Return Loss	dB	1950 MHz		25.3	
NF	Noise Figure	dB	1950 MHz		3.5	
$V_D$	Device Operating Voltage	V		1.9	2.2	2.5
$I_D$	Device Operating Current	mA		17	20	23
$R_{TH}$ , j-I	Thermal Resistance (junction to lead)	$^\circ\text{C}/\text{W}$			255	

**Test Conditions:**  $V_S = 5\text{ V}$   $I_D = 20\text{ mA Typ.}$   $OIP_3$  Tone Spacing = 1 MHz,  $P_{out}$  per tone = -10 dBm  
 $R_{BIAS} = 140\text{ Ohms}$   $T_L = 25^\circ\text{C}$   $Z_S = Z_L = 50\text{ Ohms}$

The information provided herein is believed to be reliable at press time. Sirenza Microdevices assumes no responsibility for inaccuracies or omissions. Sirenza Microdevices assumes no responsibility for the use of this information, and all such information shall be entirely at the user's own risk. Prices and specifications are subject to change without notice. No patent rights or licenses to any of the circuits described herein are implied or granted to any third party. Sirenza Microdevices does not authorize or warrant any Sirenza Microdevices product for use in life-support devices and/or systems. Copyright 2001 Sirenza Microdevices, Inc. All worldwide rights reserved.

## Typical RF Performance at Key Operating Frequencies

Symbol	Parameter	Unit	Frequency (MHz)					
			100	500	850	1950	2400	3500
G	Small Signal Gain	dB		14.9	14.7	13.5	13.2	
OIP <sub>3</sub>	Output Third Order Intercept Point	dBm		20.4	20.2	18.0	16.9	
P <sub>1dB</sub>	Output Power at 1dB Compression	dBm		7.6	7.5	6.1	5.4	
IRL	Input Return Loss	dB	21.3	21.5	19.6	17.6	17.2	15.0
ORL	Output Return Loss	dB	24.1	23.0	27.8	25.3	23.4	26.7
S <sub>12</sub>	Reverse Isolation	dB	17.8	18.5	18.7	19.1	19.2	19.2
NF	Noise Figure	dB		3.3	3.2	3.5	4.0	

**Test Conditions:**  $V_S = 5\text{ V}$ ,  $I_D = 20\text{ mA Typ.}$ , OIP<sub>3</sub> Tone Spacing = 1 MHz, Pout per tone = -10 dBm  
 $R_{BIAS} = 140\text{ Ohms}$ ,  $T_L = 25^\circ\text{C}$ ,  $Z_S = Z_L = 50\text{ Ohms}$

**Noise Figure vs. Frequency**  
 $V_D = 2.2\text{ V}$ ,  $I_D = 20\text{ mA}$

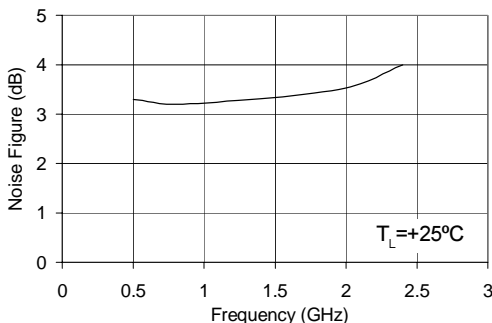

### Absolute Maximum Ratings

Parameter	Absolute Limit
Max. Device Current ( $I_D$ )	40 mA
Max. Device Voltage ( $V_D$ )	4 V
Max. RF Input Power	+18 dBm
Max. Junction Temp. ( $T_J$ )	+150°C
Operating Temp. Range ( $T_L$ )	-40°C to +85°C
Max. Storage Temp.	+150°C

Operation of this device beyond any one of these limits may cause permanent damage. For reliable continuous operation, the device voltage and current must not exceed the maximum operating values specified in the table on page one.  
 Bias conditions should also satisfy the following expression:  
 $I_D V_D < (T_J - T_L) / R_{TH} \cdot J$

**OIP<sub>3</sub> vs. Frequency**  
 $V_D = 2.2\text{ V}$ ,  $I_D = 20\text{ mA}$

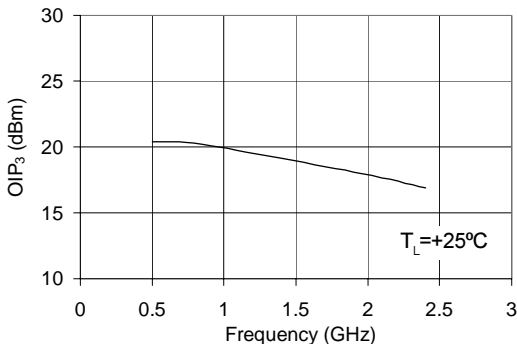

**P<sub>1dB</sub> vs. Frequency**  
 $V_D = 2.2\text{ V}$ ,  $I_D = 20\text{ mA}$

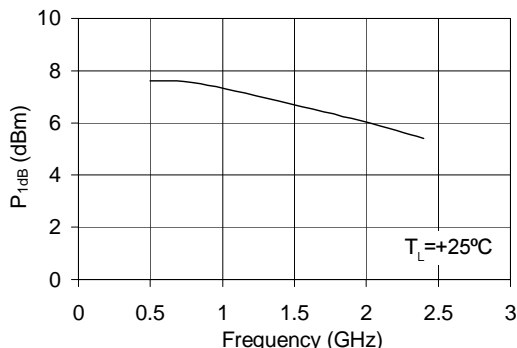

**Typical RF Performance Over Temperature ( Bias:  $V_D = 2.2$  V,  $I_D = 20$  mA (Typ.) )**

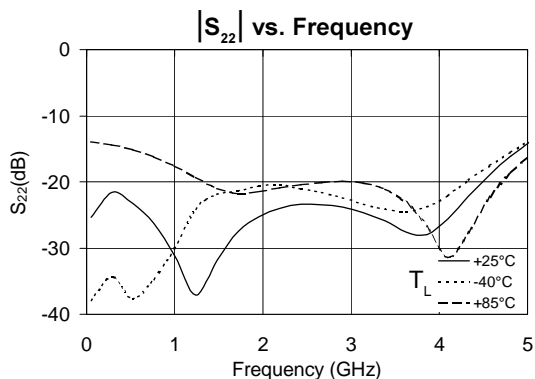
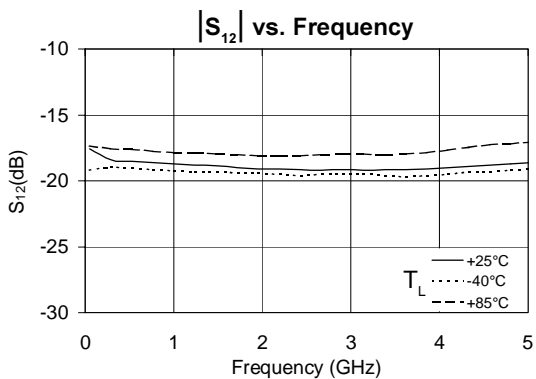
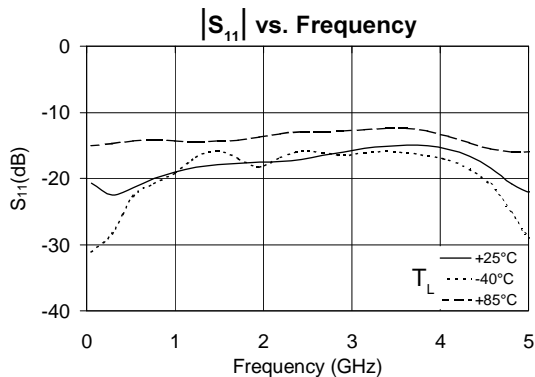
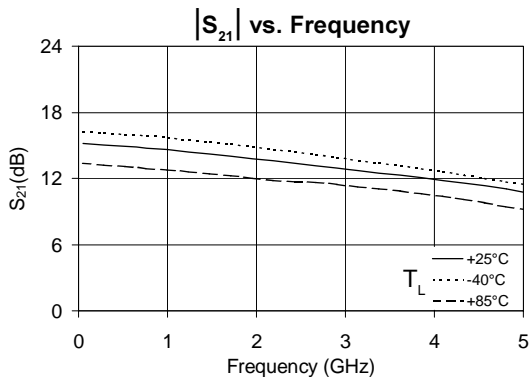

NOTE: Full S-parameter data available at [www.sirenza.com](http://www.sirenza.com)

## Basic Application Circuit

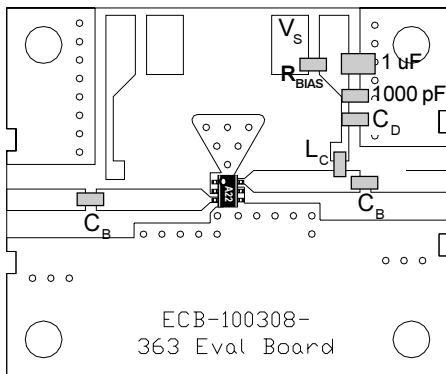
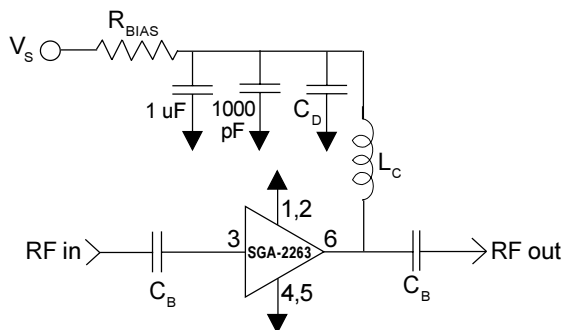

### Part Identification Marking

The part will be marked with an "A22" designator on the top surface of the package.

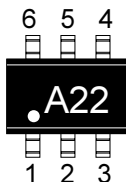

### Caution: ESD sensitive

Appropriate precautions in handling, packaging and testing devices must be observed.

### Application Circuit Element Values

Reference Designator	Frequency (Mhz)				
	500	850	1950	2400	3500
C <sub>B</sub>	220 pF	100 pF	68 pF	56 pF	39 pF
C <sub>D</sub>	100 pF	68 pF	22 pF	22 pF	15 pF
L <sub>C</sub>	68 nH	33 nH	22 nH	18 nH	15 nH

### Recommended Bias Resistor Values for I<sub>D</sub>=20mA

$$R_{BIAS} = (V_S - V_D) / I_D$$

Supply Voltage (V <sub>S</sub> )	5 V	6 V	8 V	10 V
R <sub>BIAS</sub>	140 Ω	200 Ω	300 Ω	390 Ω

Note: R<sub>BIAS</sub> provides DC bias stability over temperature.

### Mounting Instructions

1. Use a large ground pad area near device pins 1, 2, 4, and 5 with many plated through-holes as shown.
3. We recommend 1 or 2 ounce copper. Measurements for this data sheet were made on a 31 mil thick FR-4 board with 1 ounce copper on both sides.

Pin #	Function	Description
3	RF IN	RF input pin. This pin requires the use of an external DC blocking capacitor chosen for the frequency of operation.
1, 2, 4, 5	GND	Connection to ground. Use via holes for best performance to reduce lead inductance as close to ground leads as possible.
6	RF OUT/BIAS	RF output and bias pin. DC voltage is present on this pin, therefore a DC blocking capacitor is necessary for proper operation.

### Part Number Ordering Information

Part Number	Reel Size	Devices/Reel
SGA-2263	7"	3000

**PCB Pad Layout**

Dimensions in inches [millimeters]

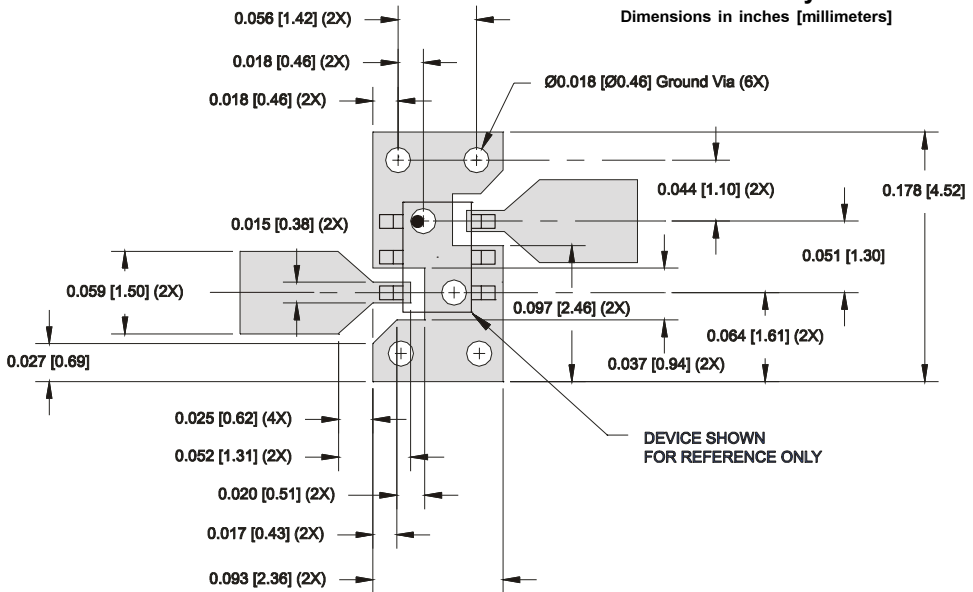

**Nominal Package Dimensions**

Dimensions in inches [millimeters]

Refer to drawing posted at [www.sirenza.com](http://www.sirenza.com) for tolerances.

