

WATER COOLED A.C. SWITCH

2-2W5I-AT603

Repetitive voltage up to **1600 V**
Maximum continuous RMS current **880 A**
Surge current **8.8 kA**

FINAL SPECIFICATION

giu 02 - ISSUE : 01

Symbol	Characteristic	Conditions	T _J [°C]	Value	Unit
BLOCKING					
V _{DRM} /V _{RRM}	Repetitive peak voltage		125	1600	V
V _{DSM} /V _{RSM}	Non-repetitive peak voltage		125	1700	V
I _{DRM} /I _{RRM}	Repetitive peak current		125	50	mA
CONDUCTING					
I _{T(RMS)}	Maximum continuous RMS current	50 Hz, Q = 4 l/min, water temperature = 40°C		880	A
I _{TSM}	Surge on-state current	Max peak one cycle sine wave, 10 ms.	125	8.8	kA
I ² t	I ² t	Without reverse voltage reapplied		387 x1E3	A ² s
V _{TM}	Max peak on-state voltage	ITM = 1240 A	125	1.63	V
V _{T(TO)}	Threshold voltage		125	0.91	V
r _T	On-state slope resistance		125	0.580	mΩ
SWITCHING					
di/dt	Critical rate of rise of on-state current, min.	From 75% V _{DRM} up to 1650 A, gate 10 V - 5 Ω	125	200	A/μs
dv/dt	Critical rate of rise of off-state voltage, min.	Linear ramp up to 70% of V _{DRM}	125	500	V/μs
GATE					
V _{GT}	Gate trigger voltage	VD=5 V	25	3.5	V
I _{GT}	Gate trigger current	VD=5 V	25	200	mA
P _{GM}	Max peak gate power	Pulse width 100 μs	25	150	W
MECHANICAL					
R _{th(j-w)}	Thermal impedance, DC	Junction to water (double side cooled)		0.21	°C/W
V _{ins(RMS)}	Insulation voltage rms	1 min	25	2.5	kV
Press	Max water pressure			10	bar
T _{J max}	Max operating junction temperature			125	°C
Weight				3500	g
Thermal switch open 63°C, closed 50°C. 10 A - 250 V					

OUTLINE **W1**

DEVICES TYPE: AT603

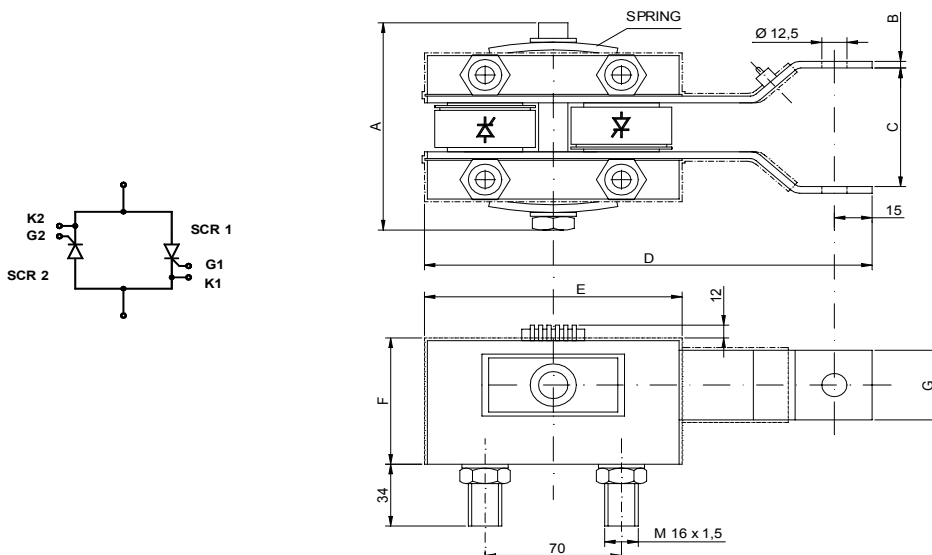

A	130
B	5
C	60
D	230
E	130
F	64
G	40
SPRING	1+1

ORDERING INFORMATION : 2-2W5I-AT603 S 16

standard specification

VDRM&VRRM/100