

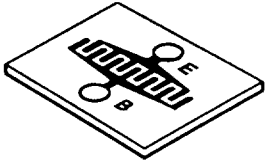

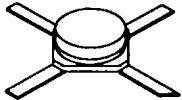
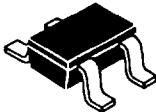

FEATURES

- **HIGH GAIN BANDWIDTH PRODUCT:** $f_T = 10 \text{ GHz}$
- **LOW NOISE FIGURE:**
1.7 dB at 2 GHz
2.6 dB at 4 GHz
- **HIGH ASSOCIATED GAIN:**
12.5 dB at 2 GHz
8.0 dB at 4 GHz
- **EXCELLENT LOW VOLTAGE LOW CURRENT PERFORMANCE**

DESCRIPTION

The NE680 series of NPN epitaxial silicon transistors is designed for low noise, high gain and low cost applications. Both the chip and micro-x versions are suitable for applications up to 6 GHz. The NE680 die is also available in six different low cost plastic surface mount package styles. The NE680's high f_T makes it ideal for low voltage/low current applications, down to as low as 0.5 V / 0.5 mA. IC max for the NE680 series is 35 mA. For higher current applications see the NE681 series.

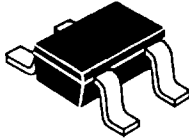
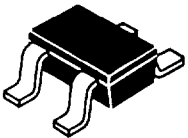
	
00 (CHIP)	35 (MICRO-X)
	
18 (SOT 343 STYLE)	19 (3 PIN ULTRA SUPER MINI MOLD)
	
30 (SOT 323 STYLE)	33 (SOT 23 STYLE)
	
39 (SOT 143 STYLE)	39R (SOT 143R STYLE)

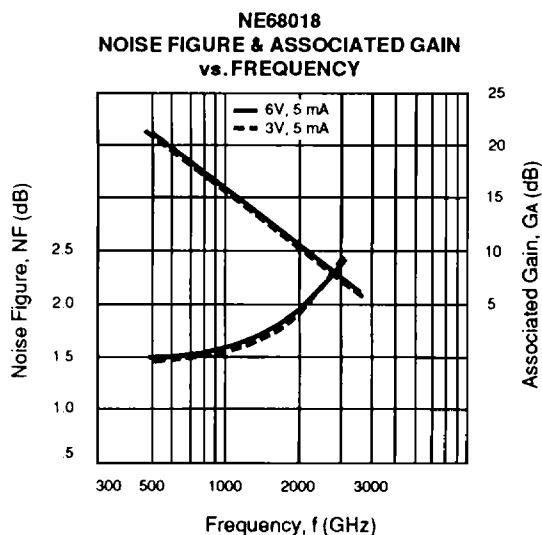

ELECTRICAL CHARACTERISTICS (T_A = 25°C)

PART NUMBER EIAJ ¹ REGISTERED NUMBER PACKAGE OUTLINE			NE68000 00 (CHIP)			NE68018 2SC5013 18			NE68019 2SC5008 19		
SYMBOLS	PARAMETERS AND CONDITIONS	UNITS	MIN	TYP	MAX	MIN	TYP	MAX	MIN	TYP	MAX
f _T	Gain Bandwidth Product at V _{CE} = 6 V, I _C = 10 mA	GHz		10			10			10	
NF	Noise Figure at V _{CE} = 6 V, I _C = 5 mA, f = 1 GHz f = 2 GHz f = 4 GHz	dB dB dB		1.7 2.6	2.4		1.6 1.8	3		1.7 1.9	
GNF	Associated Gain at Noise Figure at V _{CE} = 6 V, I _C = 5 mA, f = 1 GHz f = 2 GHz f = 4 GHz	dB dB dB		12.5 8			14 10.2			13.5 9.6	
MAG	Maximum Available Gain at V _{CE} = 6 V, I _C = 10 mA f = 1 GHz f = 2 GHz f = 4 GHz	dB dB dB		18.5 16.2 10.2			19 12.7 8.2			18.5 11.8 7.3	
S _{21E} ²	Insertion Power Gain at V _{CE} = 6 V, I _C = 10 mA, f = 1 GHz f = 2 GHz f = 4 GHz	dB dB dB	10.5	17 12.5 7.5		7.5	15.5 9.8 4.6			15 9.2 4.4	
h _{FE}	Forward Current Gain ² at V _{CE} = 6 V, I _C = 10 mA V _{CE} = 3 V, I _C = 5 mA		50	100	250	50	100	250	80		160
I _{CBO}	Collector Cutoff Current at V _{CB} = 10 V, I _E = 0 mA	μA			1.0			1.0			1.0
I _{EBO}	Emitter Cutoff Current at V _{EB} = 1 V, I _C = 0 mA	μA			1.0			1.0			1.0
C _{RE} ³	Feedback Capacitance at V _{CB} = 1 V, I _E = 0 mA, f = 1 MHz	pF					0.3	0.7		0.3	0.7
P _T	Total Power Dissipation	mW			400			150			100
R _{TH} (J-A)	Thermal Resistance (Junction to Ambient)	°C/W						833			1000
R _{TH} (J-C)	Thermal Resistance (Junction to Case)	°C/W			120			200			200

3

ELECTRICAL CHARACTERISTICS (T_A = 25°C)

PART NUMBER EIAJ ¹ REGISTERED NUMBER PACKAGE OUTLINE			NE68030 2SC4228 30			NE68033 2SC3585 33			NE68035 2SC3587 35			NE68039/39R 2SC4095 39		
SYMBOLS	PARAMETERS AND CONDITIONS	UNITS	MIN	TYP	MAX	MIN	TYP	MAX	MIN	TYP	MAX	MIN	TYP	MAX
f _T	Gain Bandwidth Product at V _{CE} = 6 V, I _C = 10 mA	GHz		10			10			10			10	
NF	Noise Figure at V _{CE} = 6 V, I _C = 5 mA, f = 1 GHz f = 2 GHz f = 4 GHz	dB dB dB		1.5 1.7 2.9			1.6 1.8 2.1	3.0		1.7 2.6	2.4		1.7 2.6	2.5
GNF	Associated Gain at Noise Figure at V _{CE} = 6 V, I _C = 5 mA, f = 1 GHz f = 2 GHz f = 4 GHz	dB dB dB		12.5 9.4 5.3			11.0 9.0 4.2			12.5 8			11 6.5	
MAG	Maximum Available Gain at V _{CE} = 6 V, I _C = 10 mA f = 1 GHz f = 2 GHz f = 4 GHz	dB dB dB		17 10.9 6.8			17 10.9 6.7			18.5 16.2 10.2			18 12.4 8.7	
S _{21E} ²	Insertion Power Gain at V _{CE} = 6 V, I _C = 10 mA, f = 1 GHz f = 2 GHz f = 2 GHz	dB dB dB		13.5 8.5 3.6			13 6.7 3.7		10.5	17 12.5 7.5			14.5 9.6 4.9	
h _{FE}	Forward Current Gain ² at V _{CE} = 6 V, I _C = 10 mA V _{CE} = 3 V, I _C = 5 mA		50	100	250	50	100	250	50	100	250	50	100	250
I _{CBO}	Collector Cutoff Current at V _{CB} = 10 V, I _E = 0 mA	μA			1.0			1.0			1.0			1.0
I _{EBO}	Emitter Cutoff Current at V _{EB} = 1 V, I _C = 0 mA	μA			1.0			1.0			1.0			1.0
C _{RE} ³	Feedback Capacitance at V _{CB} = 3 V, I _E = 0 mA, f = 1 MHz V _{CE} = 10 V, I _E = 0 mA, f = 1 MHz	pF pF		0.3	0.7		0.3	0.8		0.2	0.7		0.25	0.8
P _T	Total Power Dissipation	mW			150			200			290			200
R _{TH} (J-A)	Thermal Resistance (Junction to Ambient)	°C/W			833			620			550			620
R _{TH} (J-C)	Thermal Resistance (Junction to Case)	°C/W			200			200			200			200

Notes:

- Electronic Industrial Association of Japan.
- Pulsed measurement, PW ≤ 350 μs, duty cycle ≤ 2%.

- The emitter terminal should be connected to the ground terminal of the 3 terminal capacitance bridge.

NE680 SERIES

ABSOLUTE MAXIMUM RATINGS¹ (T_A = 25°C)

SYMBOLS	PARAMETERS	UNITS	RATINGS
V _{CB0}	Collector to Base Voltage	V	20
V _{CE0}	Collector to Emitter Voltage	V	10
V _{EB0}	Emitter to Base Voltage	V	1.5
I _C	Collector Current	mA	35
T _J	Junction Temperature	°C	150 ²
T _{STG}	Storage Temperature	°C	-65 to +150

Notes:

1. Operation in excess of any one of these parameters may result in permanent damage.
2. Maximum T_J for the NE68035 is 200°C.

DC POWER DERATING CURVES

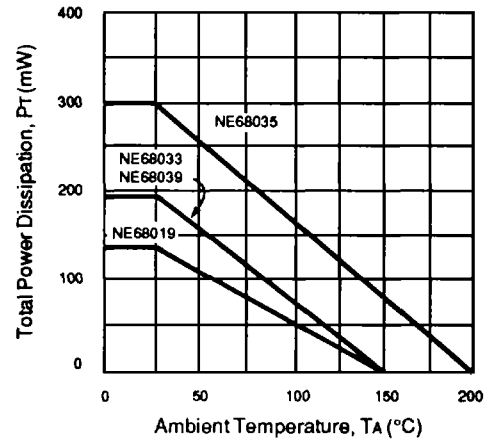

TYPICAL PERFORMANCE CURVES (T_A = 25°C)

NE68035
INSERTION GAIN vs.
COLLECTOR CURRENT

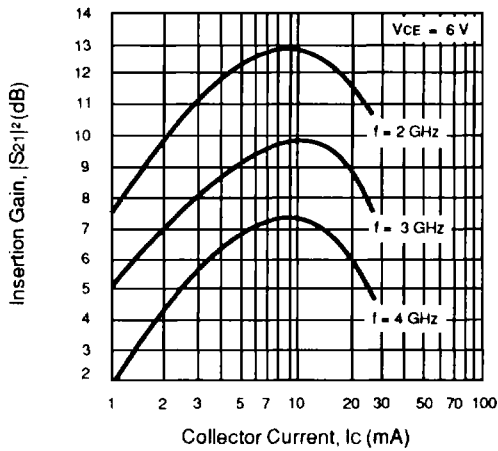

NE68033
INSERTION GAIN vs.
COLLECTOR CURRENT

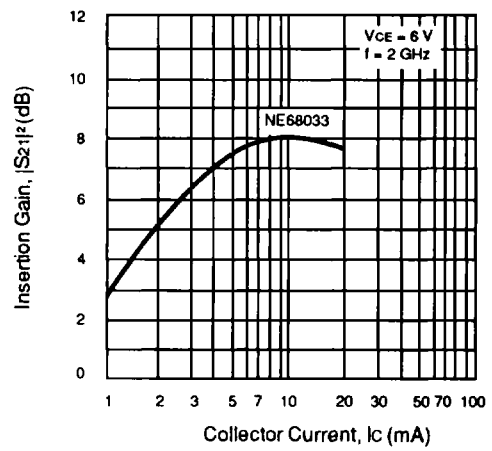

NE68039
FORWARD INSERTION GAIN
AND MAXIMUM AVAILABLE
GAIN vs. FREQUENCY

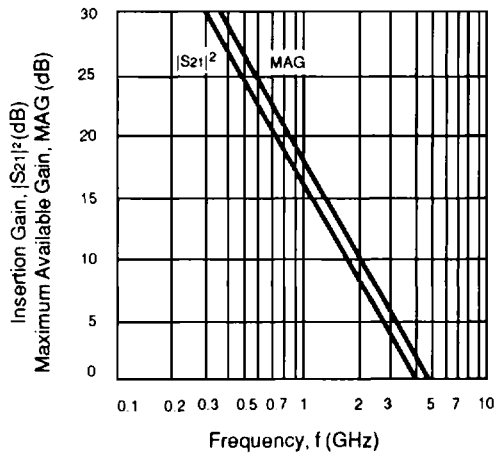

NE68035
FORWARD INSERTION GAIN
AND MAXIMUM AVAILABLE
GAIN vs. FREQUENCY

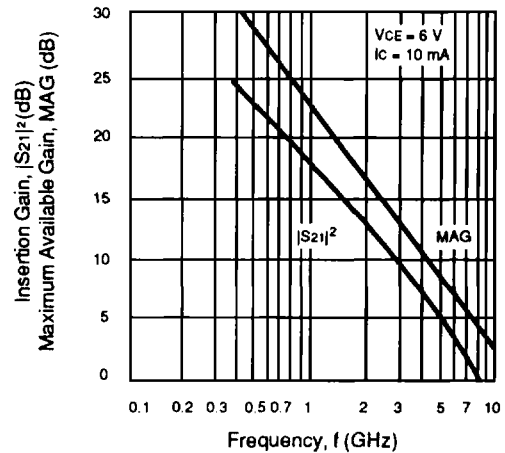

TYPICAL PERFORMANCE CURVES (TA = 25°C)

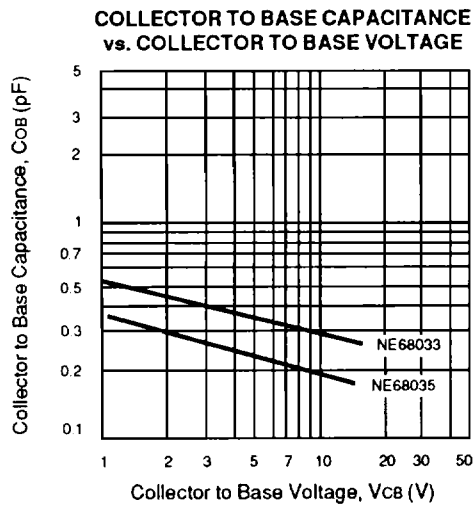
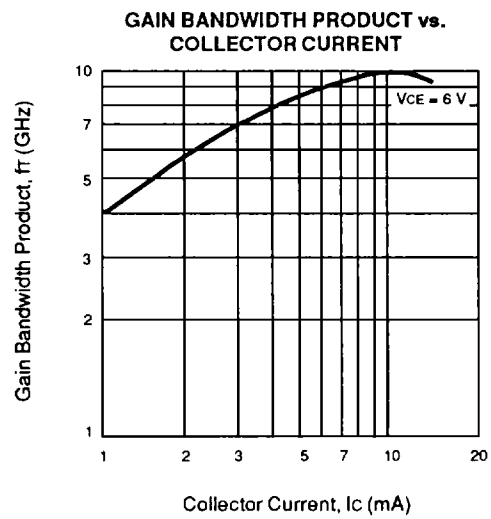
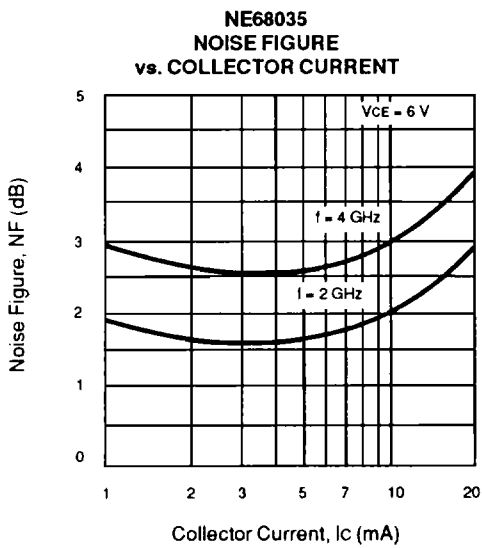
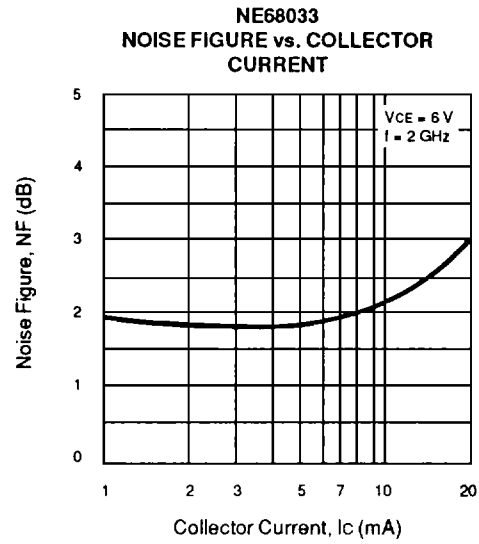
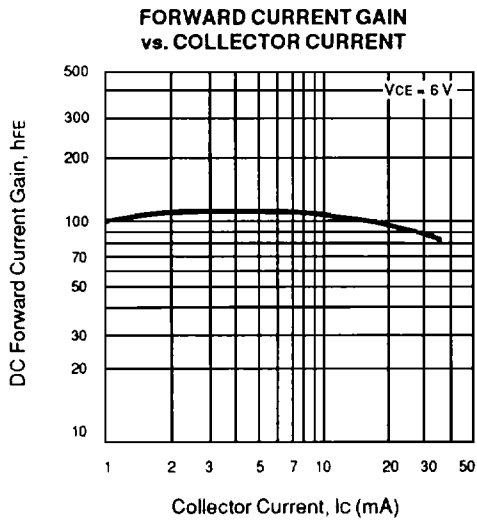

3

NE680 SERIES

NE68018

TYPICAL NOISE PARAMETERS (T_A = 25°C)

FREQ. (MHz)	NF _{OPT} (dB)	GA (dB)	Γ _{OPT}		R _n /50
			MAG	ANG	
V _{CE} = 3 V, I _c = 5 mA					
500	1.45	20.8	0.46	22	0.41
800	1.50	17.3	0.39	44	0.32
1000	1.55	15.6	0.34	54	0.29
2000	1.90	10.4	0.24	76	0.26
3000	2.40	7.3	0.16	130	0.12
V _{CE} = 6 V, I _c = 5 mA					
500	1.5	21.2	.47	21	0.44
800	1.6	17.5	.38	36	0.31
1000	1.6	14.1	.44	47	0.43
2000	2.1	10.2	.32	81	0.27
3000	2.4	7.7	.19	125	0.14

NE68019

TYPICAL NOISE PARAMETERS (T_A = 25°C)

FREQ. (MHz)	NF _{OPT} (dB)	GA (dB)	Γ _{OPT}		R _n /50
			MAG	ANG	
V _{CE} = 3 V, I _c = 5 mA					
500	1.36	19.2	0.52	18	0.47
800	1.47	15.7	0.48	33	0.33
1000	1.55	14.0	0.46	41	0.31
1500	1.71	11.0	0.42	58	0.27
2000	1.88	9.0	0.32	75	0.22
2500	2.06	7.4	0.27	86	0.18
3000	2.29	6.0	0.22	103	0.12
V _{CE} = 6 V, I _c = 5 mA					
500	1.36	19.8	0.56	16	0.50
800	1.47	16.3	0.54	30	0.36
1000	1.55	14.7	0.52	39	0.33
1500	1.71	11.7	0.48	58	0.30
2000	1.88	9.6	0.36	77	0.27
2500	2.06	8.0	0.30	88	0.23
3000	2.29	6.7	0.24	103	0.17

NE68035

TYPICAL NOISE PARAMETERS (T_A = 25°C)

FREQ. (MHz)	NF _{OPT} (dB)	GA (dB)	Γ _{OPT}		R _n /50
			MAG	ANG	
V _{CE} = 6 V, I _c = 5 mA					
1000	1.2	17.8	0.30	65	0.37
2000	1.7	12.5	0.20	155	0.30
4000	2.6	8.0	0.22	-128	0.33

NE68030

TYPICAL NOISE PARAMETERS (T_A = 25°C)

FREQ. (MHz)	NF _{OPT} (dB)	GA (dB)	Γ _{OPT}		R _n /50
			MAG	ANG	
V _{CE} = 2.5 V, I _c = 3 mA					
500	1.20	17.6	0.59	18	0.54
800	1.29	14.4	0.49	43	0.38
1000	1.35	12.9	0.46	49	0.35
1500	1.50	10.1	0.42	55	0.33
2000	1.67	8.2	0.39	62	0.29
2500	1.90	7.2	0.22	84	0.24
V _{CE} = 6 V, I _c = 5 mA					
500	1.49	17.5	0.56	58	0.38
1000	1.52	13.4	0.46	126	0.15
1500	1.60	11.0	0.38	169	0.08
2000	1.76	9.4	0.37	-159	0.11
3000	2.25	6.9	0.36	-132	0.14
4000	2.92	5.3	0.35	-115	0.16

NE68033

TYPICAL NOISE PARAMETERS (T_A = 25°C)

FREQ. (MHz)	NF _{OPT} (dB)	GA (dB)	Γ _{OPT}		R _n /50
			MAG	ANG	
V _{CE} = 2.5 V, I _c = 3 mA					
500	1.10	16.8	0.65	21	0.56
800	1.20	13.5	0.60	32	0.42
1000	1.27	12.1	0.52	43	0.39
1500	1.43	9.4	0.47	48	0.36
2000	1.64	7.4	0.39	53	0.32
V _{CE} = 6 V, I _c = 5 mA					
500	1.35	15.7	0.60	17	0.60
1000	1.45	11.9	0.45	33	0.48
2000	1.70	8.0	0.22	42	0.45
3000	2.10	5.7	0.11	-4	0.40
4000	2.55	4.1	0.18	-63	0.47

NE68039

TYPICAL NOISE PARAMETERS (T_A = 25°C)

FREQ. (MHz)	NF _{OPT} (dB)	GA (dB)	Γ _{OPT}		R _n /50
			MAG	ANG	
V _{CE} = 2.5 V, I _c = 3 mA					
500	1.14	17.7	0.54	18	0.41
800	1.21	14.7	0.47	28	0.35
1000	1.26	13.3	0.42	39	0.29
1500	1.40	10.7	0.31	55	0.25
2000	1.62	8.9	0.16	97	0.19
2500	1.90	7.5	0.12	146	0.19
V _{CE} = 6 V, I _c = 5 mA					
500	1.5	19	0.52	3	0.52
1000	1.6	15	0.38	29	0.40
2000	1.7	11	0.18	81	0.26
3000	2.1	8.5	0.17	-158	0.29
4000	2.6	6.5	0.40	-116	0.31

TYPICAL COMMON EMITTER SCATTERING PARAMETERS (T_A = 25°C)

NE68018

VCE = 2.5 V, IC = 1 mA

FREQUENCY (MHz)	S ₁₁		S ₂₁		S ₁₂		S ₂₂		K	MAG ¹ (dB)
	MAG	ANG	MAG	ANG	MAG	ANG	MAG	ANG		
100	.972	-9.4	3.605	170.2	.017	81.6	.995	-3.5	0.12	23.3
400	.907	-34.2	3.315	146.5	.061	65.5	.966	-20.2	0.19	17.4
800	.778	-65.1	2.897	118.1	.104	45.6	.874	-37.5	0.35	14.4
1000	.706	-78.9	2.678	105.8	.114	38.1	.841	-44.3	0.42	13.7
1500	.561	-111.0	2.173	78.7	.135	21.4	.755	-58.4	0.65	12.1
2000	.457	-139.5	1.800	56.6	.147	11.8	.712	-70.4	0.82	10.9
2500	.389	-166.6	1.545	37.3	.145	4.8	.668	-80.5	1.08	8.5
3000	.356	167.0	1.358	20.7	.150	2.4	.651	-90.6	1.2	6.9

VCE = 2.5 V, IC = 3 mA

100	.884	-12.9	9.246	166.6	.018	77.7	.964	-8.5	0.19	27.1
400	.729	-52.2	7.715	132.3	.056	58.5	.864	-27.8	0.34	21.4
800	.507	-90.1	5.509	101.2	.073	41.2	.704	-43.7	0.63	18.8
1000	.430	-105.8	4.722	89.8	.087	38.3	.657	-48.3	0.71	17.3
1500	.312	-138.0	3.398	66.8	.110	35.6	.591	-58.8	0.88	14.9
2000	.259	-167.5	2.645	48.2	.120	27.1	.561	-69.0	1.07	11.8
2500	.231	164.8	2.189	31.5	.137	23.2	.544	-78.5	1.15	9.7
3000	.223	139.5	1.876	16.9	.165	18.5	.539	-87.7	1.13	8.4

VCE = 6 V, IC = 5 mA

100	.838	-17.7	13.662	163.3	.012	80.3	.965	-9.5	0.13	30.6
400	.610	-61.4	10.216	124.3	.037	61.1	.819	-28.3	0.42	24.4
800	.381	-99.4	6.605	94.4	.063	48.9	.661	-40.1	0.73	20.2
1000	.314	-114.8	5.516	83.9	.067	47.8	.630	-43.7	0.85	19.2
1500	.223	-149.1	3.855	63.0	.092	43.1	.587	-54.1	0.97	16.2
2000	.188	-178.0	2.963	45.9	.112	34.0	.569	-63.6	1.07	12.6
2500	.185	153.8	2.417	30.3	.130	33.0	.567	-72.1	1.10	10.8
3000	.173	129.0	2.063	16.4	.155	23.5	.563	-82.5	1.10	9.3

NE68019

VCE = 2.5 V, IC = 1 mA

FREQUENCY (MHz)	S ₁₁		S ₂₁		S ₁₂		S ₂₂		K	MAG ¹ (dB)
	MAG	ANG	MAG	ANG	MAG	ANG	MAG	ANG		
100	.971	-9.9	3.456	169.4	.017	84.6	0.996	-6.2	0.03	23.1
400	.905	-34.9	3.207	145.8	.064	66.7	0.961	-20.2	0.17	17.0
800	.774	-65.1	2.751	117.3	.110	46.1	0.869	-36.6	0.37	14.0
1000	.706	-78.0	2.512	105.2	.126	38.1	0.829	-43.1	0.46	13.0
1500	.564	-106.1	2.043	80.0	.146	25.4	0.751	-54.7	0.68	11.5
2000	.453	-130.7	1.721	59.1	.155	17.5	0.695	-63.8	0.90	10.5
2500	.364	-156.6	1.497	40.9	.162	13.5	0.658	-71.6	1.08	7.9
3000	.303	174.5	1.355	24.5	.176	9.9	0.624	-79.9	1.19	6.2

VCE = 2.5 V, IC = 3 mA

100	.905	-15.3	9.292	165.2	.018	81.0	.968	-9.4	0.10	27.1
400	.726	-52.5	7.492	131.0	.057	60.9	.848	-28.7	0.34	21.2
800	.505	-87.4	5.221	100.5	.083	46.2	.684	-42.7	0.63	18.0
1000	.428	-100.0	4.439	89.5	.093	42.5	.638	-46.9	0.75	16.8
1500	.302	-126.3	3.211	67.8	.116	36.3	.582	-54.4	0.95	14.4
2000	.223	-149.5	2.520	50.2	.138	33.0	.551	-61.4	1.08	10.9
2500	.172	-177.0	2.100	34.7	.163	28.4	.532	-67.6	1.13	8.9
3000	.149	150.7	1.831	20.4	.191	22.6	.507	-75.5	1.15	7.5

VCE = 6 V, IC = 5 mA

100	.849	-18.0	13.629	162.0	.018	85.2	.949	-9.6	0.11	28.8
400	.613	-60.8	9.820	123.1	.050	60.7	.789	-29.4	0.45	22.9
800	.386	-93.9	6.206	93.8	.067	49.2	.639	-39.2	0.79	19.7
1000	.317	-105.5	5.157	83.9	.079	47.3	.607	-42.2	0.87	18.1
1500	.215	-128.5	3.615	64.1	.102	43.3	.575	-49.1	1.02	14.6
2000	.149	-149.7	2.786	47.9	.127	39.9	.563	-55.7	1.09	11.6
2500	.103	-178.6	2.298	33.5	.156	34.0	.552	-62.3	1.10	9.80
3000	.092	143.3	1.989	20.1	.185	28.9	.537	-70.2	1.10	8.40

Note:

1. Gain Calculations:

$$MAG = \frac{|S_{21}|}{|S_{12}|} (K \pm \sqrt{K^2 - 1})$$

When K ≤ 1, MAG is undefined and MSG values are used. $MSG = \frac{|S_{21}|}{|S_{12}|}$, $K = \frac{1 + |\Delta|^2 - |S_{11}|^2 - |S_{22}|^2}{2 |S_{12} S_{21}|}$, $\Delta = S_{11} S_{22} - S_{21} S_{12}$

MAG = Maximum Available Gain MSG = Maximum Stable Gain



NE680 SERIES

TYPICAL COMMON EMITTER SCATTERING PARAMETERS (TA = 25°C)

NE68030

VCE = 2.5 V, IC = 1 mA

FREQUENCY (MHz)	S11		S21		S12		S22		K	MAG ¹ (dB)
	MAG	ANG	MAG	ANG	MAG	ANG	MAG	ANG		
100	.958	-8.2	3.592	171.5	.018	82.5	.988	-4.2	0.11	23.0
400	.907	-31.4	3.325	148.1	.065	70.1	.949	-16.3	0.21	17.1
800	.752	-57.5	2.807	121.4	.107	55.3	.860	-28.7	0.42	14.2
1000	.672	-68.0	2.541	110.8	.122	50.3	.814	-33.2	0.53	13.2
1500	.500	-90.6	2.058	89.1	.147	43.4	.727	-40.7	0.77	11.5
2000	.371	-108.7	1.705	71.5	.157	41.1	.687	-46.7	0.99	10.4
2500	.257	-129.3	1.479	57.1	.173	43.5	.658	-51.7	1.13	7.1
3000	.172	-154.1	1.331	45.0	.194	46.5	.638	-56.6	1.18	5.8

VCE = 2.5 V, IC = 3 mA

100	.907	-14.6	9.563	166.7	.018	75.1	.983	-8.1	0.19	27.3
400	.706	-47.3	7.296	131.3	.056	64.8	.832	-23.2	0.43	21.1
800	.461	-72.5	4.915	103.2	.084	57.3	.687	-31.8	0.74	17.7
1000	.382	-80.6	4.154	93.9	.098	56.6	.646	-34.3	0.83	16.3
1500	.238	-95.8	2.979	76.9	.131	56.1	.585	-37.7	1.00	13.6
2000	.155	-101.6	2.324	62.8	.159	54.7	.579	-42.2	1.08	9.9
2500	.078	-107.6	1.940	51.3	.194	54.2	.570	-47.0	1.09	8.2
3000	.026	-102.4	1.679	41.5	.230	51.9	.561	-51.8	1.09	6.8

VCE = 6 V, IC = 5 mA

100	.896	-13.0	11.243	163.4	.015	80.8	.970	-7.8	0.19	28.7
400	.625	-47.7	8.665	126.7	.044	67.8	.773	-21.3	0.57	22.9
800	.352	-70.0	5.657	99.9	.072	65.5	.647	-25.2	0.87	19.0
1000	.276	-75.9	4.677	91.0	.085	65.6	.616	-26.3	0.95	17.4
1200	.222	-80.2	4.003	84.7	.098	66.8	.592	-28.9	1.00	16.1
1400	.169	-83.7	3.505	79.3	.114	66.8	.574	-29.2	1.03	13.8
1600	.132	-85.2	3.132	74.1	.127	65.4	.575	-31.0	1.04	12.7
1800	.102	-85.4	2.826	68.7	.142	64.8	.572	-32.9	1.05	11.6
2000	.075	-87.7	2.580	64.3	.156	64.0	.576	-35.5	1.04	11.0
2500	.025	-72.8	2.119	54.1	.191	62.8	.555	-40.6	1.07	8.8
3000	.018	43.5	1.836	45.5	.230	59.8	.551	-45.8	1.04	7.8
3500	.069	77.5	1.627	37.6	.268	57.0	.547	-51.4	1.00	7.8
4000	.122	76.6	1.489	30.7	.311	54.0	.520	-57.8	0.98	6.8
4500	.175	73.4	1.395	23.3	.354	50.2	.482	-66.3	0.97	6.0
5000	.228	70.1	1.318	16.4	.401	46.0	.430	-74.8	0.90	5.2

VCE = 6 V, IC = 10 mA

100	.769	-21.7	20.130	156.0	.015	80.5	.936	-10.5	0.25	31.3
400	.403	-60.5	11.063	113.0	.039	69.4	.679	-20.7	0.77	24.5
600	.281	-70.3	7.969	100.1	.052	70.5	.623	-21.3	0.91	21.9
800	.209	-75.2	6.153	91.4	.067	71.0	.594	-22.3	0.98	19.6
1000	.158	-77.4	4.995	84.2	.079	70.8	.582	-23.3	1.04	16.8
1200	.129	-81.3	4.190	78.8	.096	72.2	.564	-26.1	1.05	15.0
1400	.087	-81.5	3.651	74.3	.112	70.8	.551	-26.6	1.06	13.6
1600	.062	-77.2	3.247	69.3	.129	69.3	.556	-28.7	1.05	12.6
1800	.041	-71.7	2.915	64.9	.142	68.2	.555	-30.6	1.05	11.8
2000	.025	-76.9	2.655	60.6	.157	66.5	.555	-32.9	1.05	10.9
2500	.022	34.5	2.171	51.5	.192	63.8	.549	-38.7	1.05	9.2
3000	.048	59.7	1.874	43.0	.229	61.2	.542	-43.8	1.03	8.1
3500	.080	65.8	1.658	35.3	.270	58.0	.530	-50.4	1.01	7.3
4000	.126	68.2	1.514	28.0	.314	53.3	.514	-57.6	0.98	6.8
4500	.161	70.1	1.411	20.7	.357	49.4	.478	-66.2	0.97	6.0
5000	.232	68.1	1.330	13.9	.406	45.0	.426	-76.0	0.95	5.2

Note:

Gain Calculations:

$$MAG = \frac{|S_{21}|}{|S_{12}|} (K \pm \sqrt{K^2 - 1}) \text{ . When } K \leq 1, \text{ MAG is undefined and MSG values are used. } MSG = \frac{|S_{21}|}{|S_{12}|} \text{ , } K = \frac{1 + |\Delta|^2 - |S_{11}|^2 - |S_{22}|^2}{2 |S_{12} S_{21}|} \text{ , } \Delta = S_{11} S_{22} - S_{21} S_{12}$$

MAG = Maximum Available Gain

MSG = Maximum Stable Gain

TYPICAL COMMON EMITTER SCATTERING PARAMETERS (T_A = 25°C)

NE68033

VCE = 2.5 V, IC = 1 mA

FREQUENCY (MHz)	S ₁₁		S ₂₁		S ₁₂		S ₂₂		K	MAG ¹
	MAG	ANG	MAG	ANG	MAG	ANG	MAG	ANG		
100	.967	-8.2	3.635	170.6	.019	81.5	.990	-4.1	0.14	22.8
400	.903	-29.4	3.254	147.9	.069	71.0	.948	-16.8	0.23	16.7
800	.732	-53.1	2.758	121.3	.116	56.2	.846	-29.0	0.48	13.8
1000	.658	-62.8	2.508	110.3	.131	51.9	.801	-33.5	0.58	12.8
1500	.478	-83.0	2.043	88.2	.154	46.9	.715	-41.4	0.82	11.2
2000	.349	-100.5	1.708	71.1	.173	46.2	.663	-47.5	1.00	9.9
2500	.242	-114.6	1.507	56.5	.194	48.6	.633	-53.4	1.10	7.0
3000	.155	-136.7	1.371	44.6	.227	50.9	.609	-59.7	1.11	5.8

VCE = 2.5 V, IC = 3 mA

100	.906	-13.9	9.367	165.4	.019	84.5	.972	-7.4	0.1	26.9
400	.704	-43.9	7.037	130.3	.058	65.0	.821	-23.5	0.48	20.8
800	.448	-64.8	4.712	103.1	.093	60.4	.670	-31.2	0.78	17.0
1000	.370	-71.3	3.960	93.7	.106	59.8	.632	-33.1	0.88	15.7
1500	.241	-80.5	2.864	76.6	.144	59.3	.582	-37.1	1.00	13.0
2000	.167	-85.7	2.263	63.0	.181	58.0	.563	-41.8	1.05	9.6
2500	.104	-81.4	1.916	51.6	.221	56.3	.552	-47.0	1.06	7.9
3000	.065	-78.4	1.700	41.6	.264	53.4	.541	-53.3	1.03	7.0

VCE = 6 V, IC = 5 mA

100	0.873	-15.2	13.221	162.1	0.015	84.0	0.967	-7.9	0.15	29.5
400	0.587	-48.0	9.077	124.0	0.046	67.6	0.776	-20.0	0.60	23.0
800	0.327	-64.7	5.604	99.1	0.075	66.7	0.650	-22.5	0.89	18.7
1000	0.251	-68.9	4.648	91.1	0.088	67.3	0.622	-23.3	0.96	17.2
1500	0.134	-74.1	3.277	76.3	0.124	67.3	0.583	-26.2	1.04	13.0
2000	0.057	-71.7	2.557	64.8	0.161	66.2	0.564	-30.4	1.05	10.6
2500	0.015	-17.4	2.122	54.6	0.200	64.3	0.552	-35.4	1.04	9.0
3000	0.033	64.9	1.850	46.1	0.239	61.7	0.546	-41.0	1.01	8.3
3500	0.071	72.0	1.647	37.9	0.280	58.9	0.540	-47.2	0.98	7.7
4000	0.108	74.2	1.510	30.6	0.322	55.7	0.532	-54.1	0.95	6.7
4500	0.141	73.9	1.408	23.7	0.366	52.3	0.520	-61.7	0.92	5.9
5000	0.189	70.1	1.325	16.4	0.413	48.7	0.502	-69.9	0.89	5.1

VCE = 6 V, IC = 10 mA

50	.817	-10.6	21.366	168.2	.006	85.7	.974	-5.5	0.13	35.5
100	.769	-21.7	20.130	156.0	.015	80.5	.936	-10.5	0.25	31.3
200	.628	-40.1	16.661	136.5	.024	71.6	.826	-17.6	0.48	28.4
400	.403	-60.5	11.063	113.0	.039	69.4	.679	-20.7	0.77	24.5
600	.281	-70.3	7.969	100.1	.052	70.5	.623	-21.3	0.91	21.9
800	.209	-75.2	6.153	91.4	.067	71.0	.594	-22.3	0.98	19.6
1000	.158	-77.4	4.995	84.2	.079	70.8	.582	-23.3	1.04	16.8
1200	.129	-81.3	4.190	78.8	.096	72.2	.564	-26.1	1.05	15.0
1400	.087	-81.5	3.651	74.3	.112	70.8	.551	-26.6	1.06	13.6
1600	.062	-77.2	3.247	69.3	.129	69.3	.556	-28.7	1.05	12.6
1800	.041	-71.7	2.915	64.9	.142	68.2	.555	-30.6	1.05	11.8
2000	.025	-76.9	2.655	60.6	.157	66.5	.555	-32.9	1.05	10.9
2500	.022	34.5	2.171	51.5	.192	63.8	.549	-38.7	1.05	9.2
3000	.048	59.7	1.874	43.0	.229	61.2	.542	-43.8	1.03	8.1
3500	.080	65.8	1.658	35.3	.270	58.0	.530	-50.4	1.01	7.3
4000	.126	68.2	1.514	28.0	.314	53.3	.514	-57.6	0.98	6.8
4500	.161	70.1	1.411	20.7	.357	49.4	.478	-66.2	0.97	6.0
5000	.232	68.1	1.330	13.9	.406	45.0	.426	-76.0	0.95	5.2

Note:

1. Gain Calculations:

$$MAG = \frac{|S_{21}|}{|S_{12}|} (K \pm \sqrt{K^2 - 1})$$

When K ≤ 1, MAG is undefined and MSG values are used. $MSG = \frac{|S_{21}|}{|S_{12}|}$, $K = \frac{1 + |\Delta|^2 - |S_{11}|^2 - |S_{22}|^2}{2 |S_{12} S_{21}|}$, $\Delta = S_{11} S_{22} - S_{21} S_{12}$

MAG = Maximum Available Gain

MSG = Maximum Stable Gain



NE680 SERIES

TYPICAL COMMON EMITTER SCATTERING PARAMETERS (TA = 25°C)

NE68035

VCE = 6 V, IC = 5 mA

FREQUENCY (MHz)	S11		S21		S12		S22		K	MAG ¹ (dB)
	MAG	ANG	MAG	ANG	MAG	ANG	MAG	ANG		
100	0.84	-13	12.98	169	0.01	78	0.99	-5	0.16	31.1
500	0.65	-63	10.85	131	0.03	61	0.79	-24	0.42	25.6
1000	0.46	-103	7.19	102	0.04	51	0.64	-32	0.86	22.5
1500	0.37	-127	5.19	86	0.05	49	0.65	-37	0.97	20.2
2000	0.30	-150	4.07	72	0.07	44	0.59	-42	1.07	16.0
2500	0.31	-177	3.23	62	0.09	44	0.55	-45	1.09	13.7
3000	0.30	165	2.78	51	0.10	43	0.54	-53	1.14	12.2
3500	0.30	150	2.43	39	0.11	39	0.53	-59	1.20	10.7
4000	0.32	137	2.19	32	0.11	38	0.53	-68	1.29	9.8
4500	0.33	124	1.95	24	0.11	37	0.53	-74	1.43	8.6
5000	0.35	114	1.80	14	0.11	32	0.53	-83	1.51	7.9

VCE = 6 V, IC = 10 mA

100	0.72	-20	20.47	165	0.01	78	0.97	-7	0.17	33.1
500	0.49	-87	13.90	119	0.03	63	0.69	-25	0.55	26.7
1000	0.35	-128	8.14	94	0.04	56	0.57	-30	0.95	23.1
1500	0.29	-148	5.65	80	0.05	58	0.60	-34	1.05	19.2
2000	0.27	-172	4.38	68	0.07	53	0.55	-37	1.08	16.2
2500	0.30	161	3.49	58	0.09	52	0.51	-44	1.08	14.2
3000	0.30	147	2.95	48	0.10	50	0.50	-50	1.15	12.3
3500	0.31	135	2.59	37	0.11	46	0.51	-56	1.16	11.3
4000	0.33	125	2.32	30	0.11	44	0.51	-66	1.26	10.2
4500	0.35	114	2.05	23	0.11	42	0.51	-72	1.39	9.0
5000	0.37	106	1.89	13	0.11	37	0.51	-81	1.47	8.3

VCE = 6 V, IC = 15 mA

100	0.63	-26	24.77	161	0.01	84	0.95	-8	0.15	33.9
500	0.41	-104	14.52	113	0.04	75	0.65	-24	0.51	25.6
1000	0.33	-143	8.07	90	0.05	65	0.56	-27	0.81	22.1
1500	0.30	-163	5.55	77	0.05	61	0.60	-31	1.03	19.4
2000	0.28	177	4.26	65	0.07	57	0.56	-35	1.06	16.3
2500	0.31	152	3.34	57	0.09	56	0.53	-42	1.07	14.1
3000	0.33	143	2.90	46	0.10	54	0.51	-49	1.11	12.6
3500	0.34	131	2.51	36	0.11	50	0.52	-55	1.13	11.4
4000	0.36	122	2.24	29	0.12	47	0.52	-64	1.14	10.4
4500	0.37	112	1.99	22	0.12	46	0.53	-71	1.24	9.2
5000	0.39	104	1.83	12	0.12	40	0.53	-79	1.31	8.5

VCE = 6 V, IC = 20 mA

100	0.55	-34	26.43	158	0.01	85	0.94	-8	0.15	34.2
500	0.39	-121	13.59	109	0.02	83	0.65	-21	0.81	28.3
1000	0.34	-158	7.37	87	0.04	70	0.58	-24	0.96	22.7
1500	0.32	-175	5.0	75	0.05	64	0.62	-29	1.04	18.8
2000	0.31	168	3.87	64	0.07	62	0.60	-34	1.02	16.6
2500	0.35	148	3.08	55	0.08	60	0.56	-41	1.15	13.5
3000	0.37	138	2.62	45	0.10	58	0.55	-47	1.08	12.5
3500	0.38	128	2.28	35	0.10	53	0.56	-55	1.20	10.9
4000	0.40	119	2.05	28	0.10	51	0.55	-64	1.33	9.7
4500	0.41	109	1.80	21	0.10	49	0.56	-70	1.48	8.5
5000	0.43	101	1.67	11	0.10	43	0.56	-79	1.55	7.9

Note:

1. Gain equations:

$$\text{MAG} = \frac{|S_{21}|}{|S_{12}|} \left(K \pm \sqrt{K^2 - 1} \right). \text{ When } K \leq 1, \text{ MAG is undefined and MSG values are used. } \text{MSG} = \frac{|S_{21}|}{|S_{12}|}, K = \frac{1 + |\Delta|^2 - |S_{11}|^2 - |S_{22}|^2}{2 |S_{12} S_{21}|}, \Delta = S_{11} S_{22} - S_{21} S_{12}$$

MAG = Maximum Available Gain

MSG = Maximum Stable Gain

TYPICAL COMMON EMITTER SCATTERING PARAMETERS (TA = 25°C)

NE68039

VCE = 2.5 V, IC = 3 mA

FREQUENCY (MHz)	S11		S21		S12		S22		K	MAG ¹ (dB)
	MAG	ANG	MAG	ANG	MAG	ANG	MAG	ANG		
50	0.935	-5.8	9.685	173.9	0.007	83.3	0.990	-3.7	0.11	31.4
100	0.903	-15.3	9.393	168.4	0.015	79.8	0.984	-6.0	0.10	28.0
200	0.826	-26.3	8.809	154.7	0.028	72.7	0.951	-11.7	0.25	25.0
300	0.770	-38.7	8.225	144.2	0.039	68.7	0.899	-16.2	0.31	23.2
400	0.690	-49.6	7.593	134.7	0.051	64.6	0.850	-19.6	0.40	21.7
500	0.618	-58.1	6.894	126.4	0.060	62.3	0.806	-21.9	0.48	20.6
600	0.545	-67.5	6.290	119.4	0.067	59.4	0.759	-24.0	0.56	19.7
800	0.436	-83.4	5.266	107.3	0.079	56.5	0.689	-26.3	0.70	18.2
1000	0.353	-98.2	4.489	98.4	0.089	56.3	0.638	-27.6	0.81	17.0
1500	0.232	-138.6	3.270	80.4	0.114	56.3	0.555	-31.2	0.99	14.6
2000	0.217	-177.0	2.573	66.5	0.138	57.7	0.502	-36.5	1.08	11.0
2500	0.262	154.2	2.148	54.6	0.168	57.2	0.456	-43.4	1.08	9.3
3000	0.314	136.1	1.860	44.2	0.201	56.8	0.423	-53.6	1.05	8.3

VCE = 6 V, IC = 3 mA

100	0.918	-10	8.888	168	0.001	81	0.989	-5	0.29	39.5
200	0.891	-22	8.546	158	0.003	76	0.981	-8	0.26	34.5
400	0.757	-41	7.606	141	0.024	71	0.915	-14	0.32	25.0
600	0.634	-55	6.430	125	0.045	65	0.822	-18	0.54	21.5
800	0.511	-68	5.638	115	0.057	62	0.757	-20	0.69	20.0
1000	0.405	-78	4.839	105	0.073	61	0.700	-22	0.80	18.2
2000	0.225	-136	2.601	77	0.121	59	0.583	-29	1.09	11.5
3000	0.242	145	2.033	50	0.171	58	0.499	-41	1.07	9.1
4000	0.359	117	1.655	31	0.226	54	0.434	-64	1.00	8.6
5000	0.452	101	1.370	14	0.282	47	0.423	-91	0.92	6.9
6000	0.536	91	1.172	0	0.340	41	0.420	-116	0.84	5.4

VCE = 6 V, IC = 5 mA

100	0.864	-14	13.010	163	0.001	85	0.976	-6	0.50	41.1
200	0.805	-28	12.058	151	0.003	80	0.949	-11	0.50	36.1
400	0.622	-50	9.873	131	0.015	69	0.854	-17	0.66	28.2
600	0.483	-64	7.800	116	0.030	65	0.751	-19	0.87	24.1
800	0.366	-77	6.487	106	0.046	64	0.692	-20	0.92	21.5
1000	0.273	-87	5.410	97	0.057	66	0.644	-20	1.03	18.7
2000	0.127	-169	3.002	71	0.121	64	0.555	-26	1.06	12.4
3000	0.227	131	2.187	48	0.178	61	0.475	-39	1.03	9.8
4000	0.350	111	1.755	31	0.236	55	0.406	-62	0.98	8.7
5000	0.442	98	1.464	14	0.292	47	0.395	-89	0.90	7.0
6000	0.527	89	1.247	0	0.349	40	0.389	-114	0.84	5.5

VCE = 6 V, IC = 10 mA

100	0.756	-21	20.155	156	0.005	85	0.945	-9	0.27	36.1
200	0.647	-40	17.163	140	0.008	82	0.887	-13	0.47	33.3
400	0.423	-65	12.024	118	0.009	71	0.774	-16	1.58	26.8
600	0.301	-77	8.762	104	0.019	68	0.691	-16	1.53	22.3
800	0.211	-92	6.962	97	0.035	68	0.643	-16	1.26	19.9
1000	0.143	-108	5.674	89	0.051	71	0.614	-17	1.18	17.9
2000	0.127	146	3.089	66	0.119	70	0.551	-24	1.05	12.8
3000	0.251	120	2.207	46	0.179	64	0.477	-37	1.01	10.3
4000	0.371	107	1.768	30	0.240	57	0.407	-60	0.94	8.7
5000	0.462	95	1.471	13	0.298	49	0.392	-88	0.87	6.9
6000	0.543	87	1.247	-1	0.354	41	0.389	-114	0.82	5.5

Note:

1. Gain Calculations:

$$MAG = \frac{|S_{21}|}{|S_{12}|} \left(K \pm \sqrt{K^2 - 1} \right). \text{ When } K \leq 1, \text{ MAG is undefined and MSG values are used. } MSG = \frac{|S_{21}|}{|S_{12}|}, K = \frac{1 + |\Delta|^2 - |S_{11}|^2 - |S_{22}|^2}{2 |S_{12} S_{21}|}, \Delta = S_{11} S_{22} - S_{21} S_{12}$$

MAG = Maximum Available Gain

MSG = Maximum Stable Gain



NE680 SERIES

OUTLINE DIMENSIONS (Units in mm)

NE68000 (CHIP)
(Chip Thickness: 160 μm)

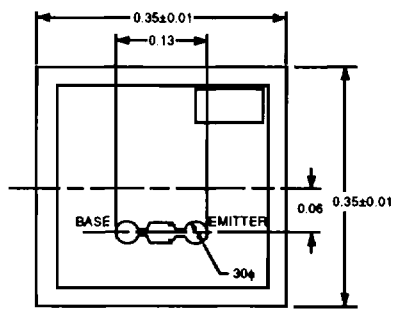

PACKAGE OUTLINE 35
(MICRO-X)

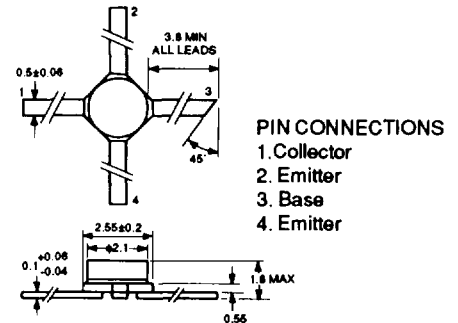

- PIN CONNECTIONS**
1. Collector
 2. Emitter
 3. Base
 4. Emitter

PACKAGE OUTLINE 18

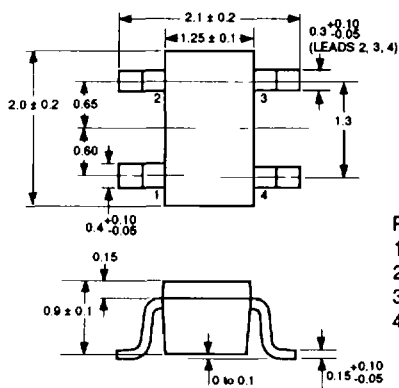

- PIN CONNECTIONS**
1. Collector
 2. Emitter
 3. Base
 4. Emitter

PACKAGE OUTLINE 18
RECOMMENDED P.C.B. LAYOUT

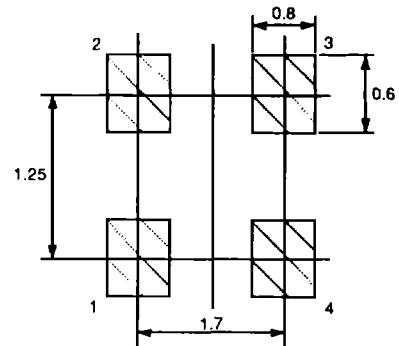

PACKAGE OUTLINE 19

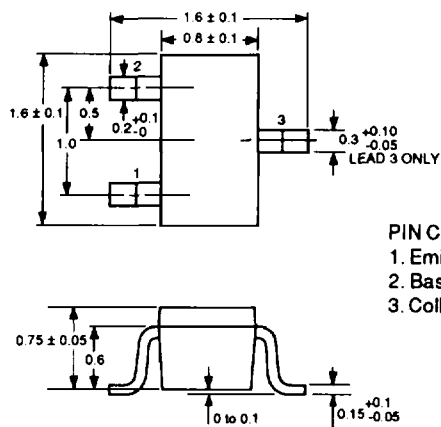

- PIN CONNECTIONS**
1. Emitter
 2. Base
 3. Collector

PACKAGE OUTLINE 19
RECOMMENDED P.C.B. LAYOUT

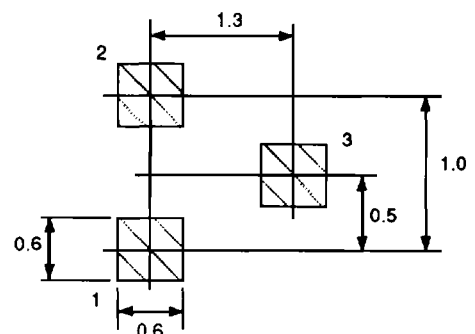

PACKAGE OUTLINE 30

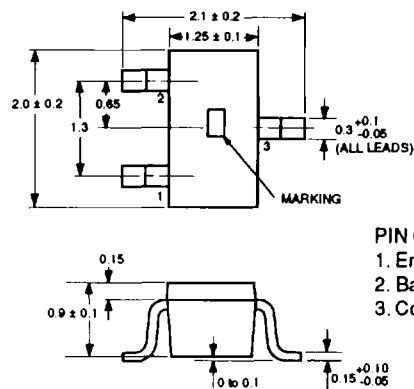

- PIN CONNECTIONS**
1. Emitter
 2. Base
 3. Collector

PACKAGE OUTLINE 30
RECOMMENDED P.C.B. LAYOUT

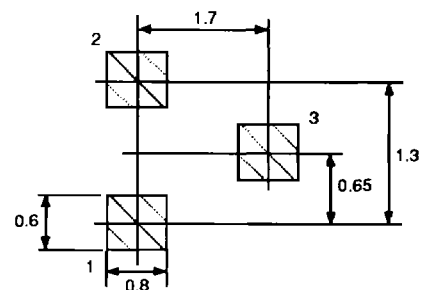

OUTLINE DIMENSIONS (Units in mm)

PACKAGE OUTLINE 33
(SOT-23)

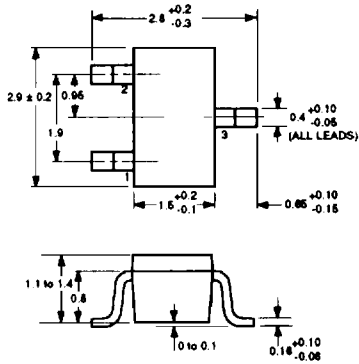

- PIN CONNECTIONS
 1. Emitter
 2. Base
 3. Collector

PACKAGE OUTLINE 33
RECOMMENDED P.C.B. LAYOUT

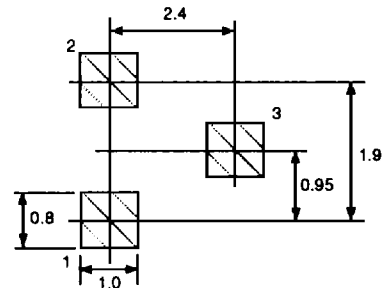

PACKAGE OUTLINE 39

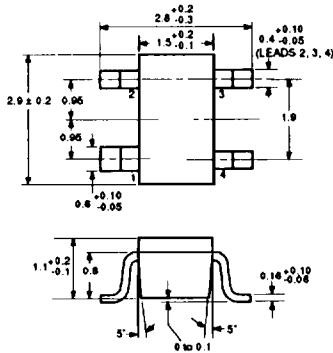

- PIN CONNECTIONS
 1. Collector
 2. Emitter
 3. Base
 4. Emitter

PACKAGE OUTLINE 39
RECOMMENDED P.C.B. LAYOUT

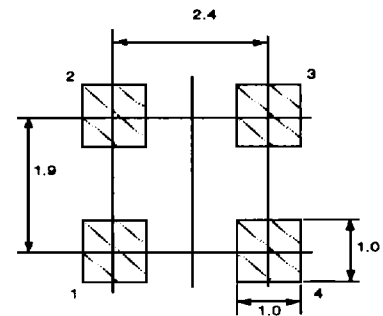

PACKAGE OUTLINE 39R

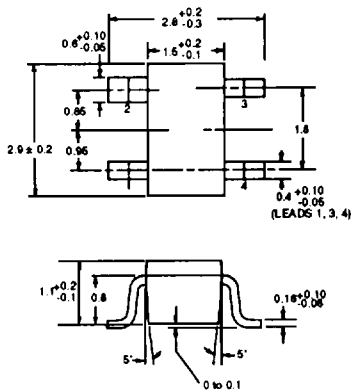

- PIN CONNECTIONS
 1. Emitter
 2. Collector
 3. Emitter
 4. Base

PACKAGE OUTLINE 39
RECOMMENDED P.C.B. LAYOUT

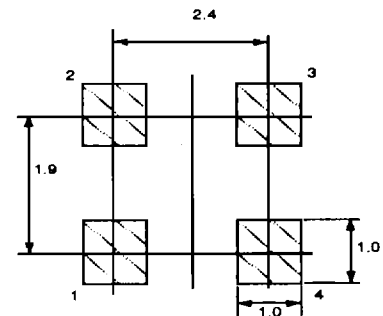

3