

CEP21A3/CEB21A3

Nov. 2002

N-Channel Logic Level Enhancement Mode Field Effect Transistor

4

FEATURES

- 30V , 20A , $R_{DS(ON)}=45m\Omega$ @ $V_{GS}=10V$.
 $R_{DS(ON)}=70m\Omega$ @ $V_{GS}=4.5V$.
- Super high dense cell design for extremely low $R_{DS(ON)}$.
- High power and current handling capability.
- TO-220 & TO-263 package.

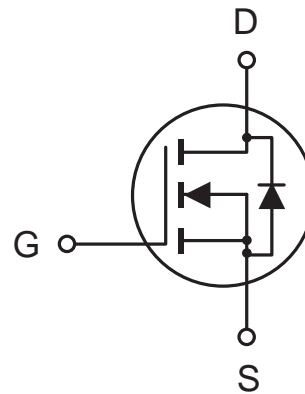

ABSOLUTE MAXIMUM RATINGS ($T_c=25^\circ C$ unless otherwise noted)

Parameter	Symbol	Limit	Unit
Drain-Source Voltage	V_{DS}	30	V
Gate-Source Voltage	V_{GS}	± 20	V
Drain Current-Continuous -Pulsed	I_D	20	A
	I_{DM}	60	A
Drain-Source Diode Forward Current	I_S	20	A
Maximum Power Dissipation @ $T_c=25^\circ C$ Derate above $25^\circ C$	P_D	43	W
		0.29	W/ $^\circ C$
Operating and Storage Temperature Range	T_J, T_{STG}	-65 to 175	$^\circ C$

THERMAL CHARACTERISTICS

Thermal Resistance, Junction-to-Case	$R_{\theta JC}$	3.5	$^\circ C/W$
Thermal Resistance, Junction-to-Ambient	$R_{\theta JA}$	62.5	$^\circ C/W$

CEP21A3/CEB21A3

4

ELECTRICAL CHARACTERISTICS (Tc=25 °C unless otherwise noted)

Parameter	Symbol	Condition	Min	Typ ^c	Max	Unit
OFF CHARACTERISTICS						
Drain-Source Breakdown Voltage	BV _{DSS}	V _{GS} = 0V, I _D = 250μA	30			V
Zero Gate Voltage Drain Current	I _{DSS}	V _{DS} = 30V, V _{GS} = 0V			1	μA
Gate-Body Leakage	I _{GSS}	V _{GS} = ± 20V, V _{DS} = 0V			±100	nA
ON CHARACTERISTICS^a						
Gate Threshold Voltage	V _{GS(th)}	V _{DS} = V _{GS} , I _D = 250μA	0.8		2.5	V
Drain-Source On-State Resistance	R _{DS(ON)}	V _{GS} = 10V, I _D = 12A		36	45	mΩ
		V _{GS} = 4.5V, I _D = 15A		55	70	mΩ
On-State Drain Current	I _{D(ON)}	V _{DS} = 10V, V _{GS} = 10V	20			A
Forward Transconductance	g _{FS}	V _{DS} = 10V, I _D = 12A		20		S
DYNAMIC CHARACTERISTICS^b						
Input Capacitance	C _{ISS}	V _{DS} = 15V, V _{GS} = 0V f = 1.0MHz		364		pF
Output Capacitance	C _{OSS}			197		pF
Reverse Transfer Capacitance	C _{RSS}			62		pF
SWITCHING CHARACTERISTICS^b						
Turn-On Delay Time	t _{D(ON)}	V _{DD} = 15V, I _D = 12A V _{GS} = 10V, R _{GEN} = 2.5Ω		12	25	ns
Rise Time	t _r			5	15	ns
Turn-Off Delay Time	t _{D(OFF)}			14	30	ns
Fall Time	t _f			14	30	ns
Total Gate Charge	Q _g	V _{DS} = 15V, I _D = 6A V _{GS} = 10V		10	15	nC
Gate-Source Charge	Q _{gs}			2		nC
Gate-Drain Charge	Q _{gd}			3		nC

CEP21A3/CEB21A3

ELECTRICAL CHARACTERISTICS ($T_c=25^\circ\text{C}$ unless otherwise noted)

Parameter	Symbol	Condition	Min	Typ	Max	Unit
DRAIN-SOURCE DIODE CHARACTERISTICS ^a						
Diode Forward Voltage	V_{SD}	$V_{GS} = 0V, I_s = 12A$		0.9	1.3	V

Notes

- a. Pulse Test: Pulse Width $\leq 300 \mu s$, Duty Cycle $\leq 2\%$.
- b. Guaranteed by design, not subject to production testing.

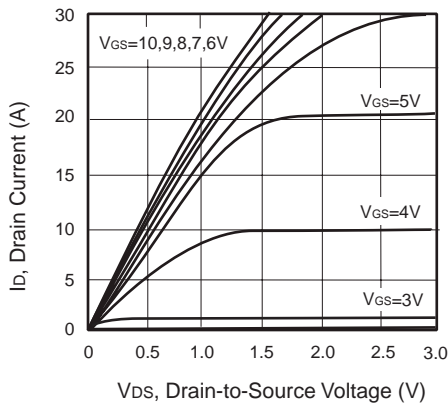

Figure 1. Output Characteristics

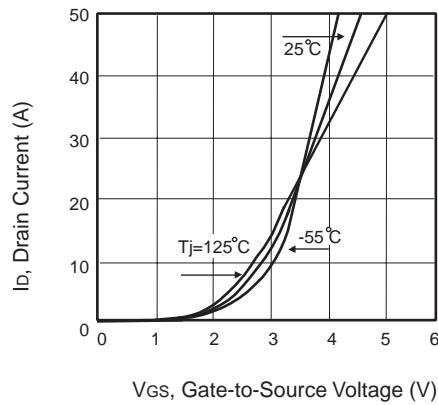

Figure 2. Transfer Characteristics

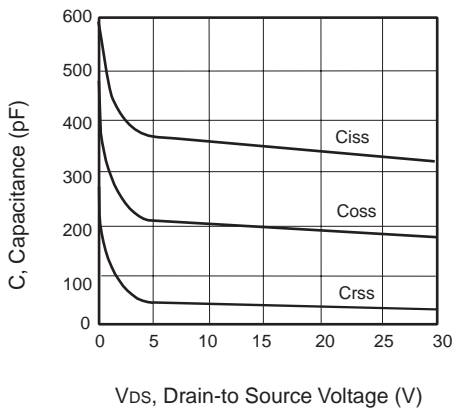

Figure 3. Capacitance

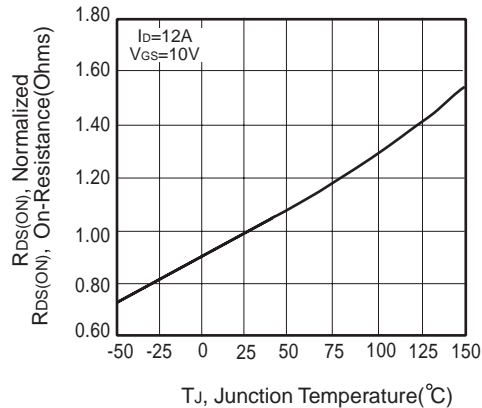

Figure 4. On-Resistance Variation with Temperature

CEP21A3/CEB21A3

4

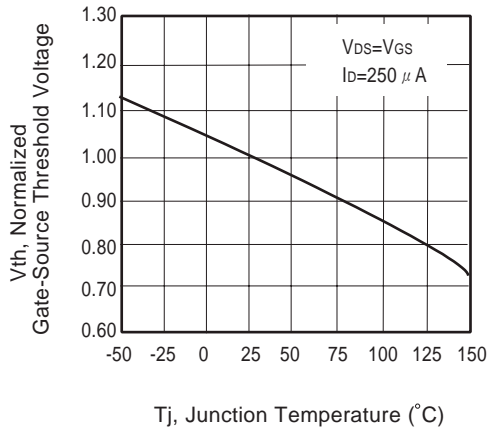

Figure 5. Gate Threshold Variation with Temperature

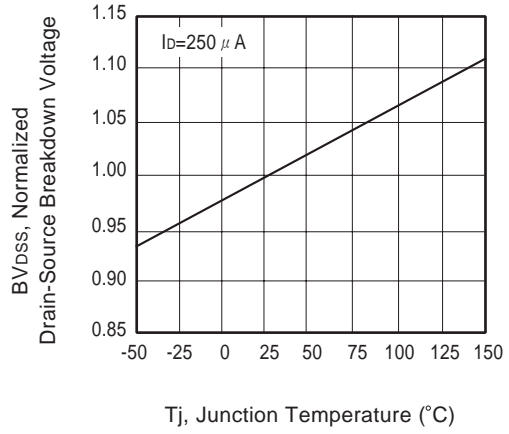

Figure 6. Breakdown Voltage Variation with Temperature

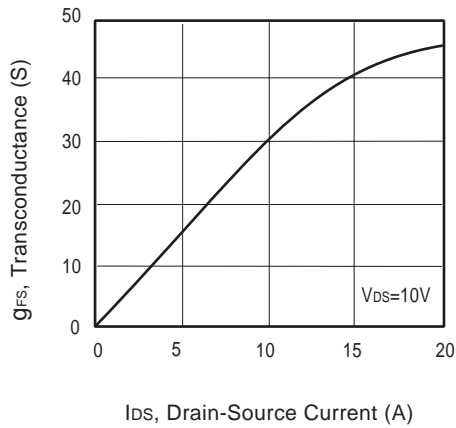

Figure 7. Transconductance Variation with Drain Current

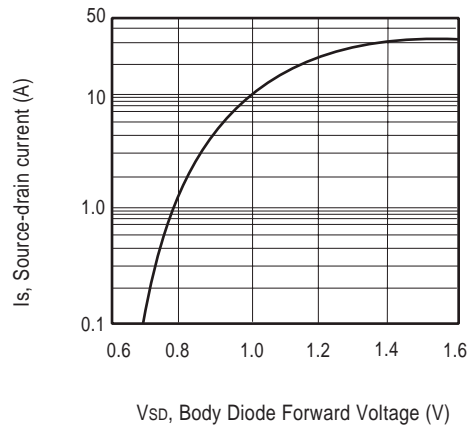

Figure 8. Body Diode Forward Voltage Variation with Source Current

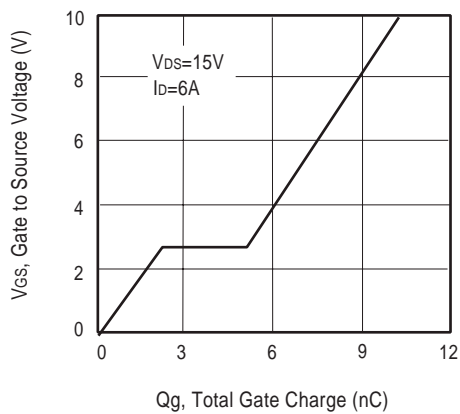

Figure 9. Gate Charge

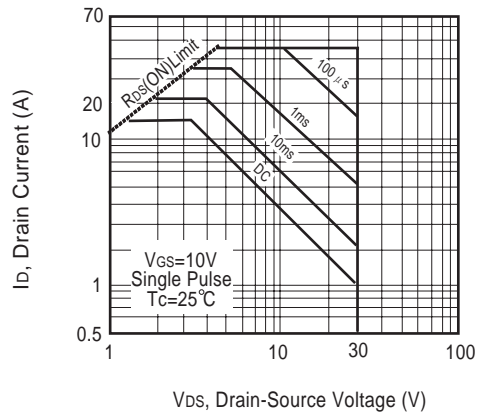

Figure 10. Maximum Safe Operating Area

CEP21A3/CEB21A3

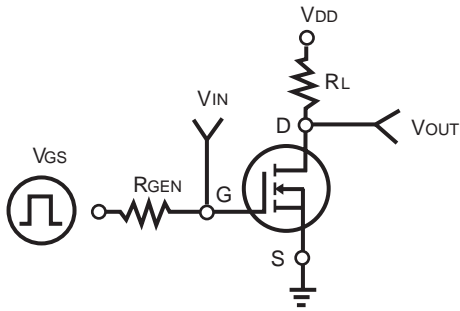

Figure 11. Switching Test Circuit

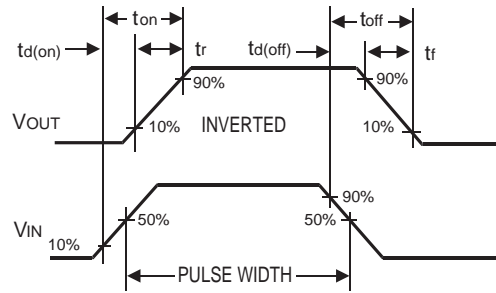

Figure 12. Switching Waveforms

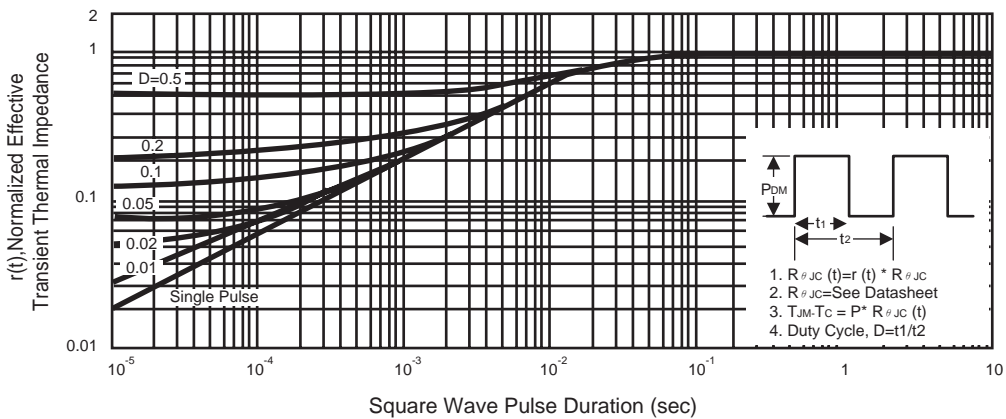

Figure 13. Normalized Thermal Transient Impedance Curve