

# Fast Recovery Diode Stud Types M0268S/RX200 to M0268S/RX250

The data sheet on the subsequent pages of this document is a scanned copy of existing data for this product.  
(Rating Report 90NR10 Issue 2)

This data reflects the old part number for this product which is: SM16-25PCN/R134.  
This part number must **NOT** be used for ordering purposes – please use the ordering particulars detailed below.

The limitations of this data are as follows:  
Only S/RC outline drawing (W22) in datasheet  
Some reverse recovery data missing  
Device no longer available for grades 16 & 18 (1600V & 1800V  $V_{RRM}$ )

The following links will direct you to the appropriate outline drawings  
[Outline W22](#) – 1/2" Ceramic stud and lug  
[Outline W24](#) – 3/4" Ceramic stud



Where any information on the product matrix page differs from that in the following data, the product matrix must be considered correct

An electronic data sheet for this product is presently in preparation.

For further information on this product, please contact your local ASM or distributor.

Alternatively, please contact Westcode as detailed below.

<b>Ordering Particulars</b>			
M0268	S/RX	◆◆	0
Fixed Type Code	S/RC – 3/4" Ceramic stud S/RJ – 1/2" Ceramic stud and lug	Voltage code $V_{RRM}/100$ 20-25	Fixed Code
Typical Order Code: M0268SC200, Normal polarity 3/4" Ceramic stud, 2000V $V_{RRM}$			

<p><b>IXYS Semiconductor GmbH</b> Edisonstraße 15 D-68623 Lampertheim Tel: +49 6206 503-0 Fax: +49 6206 503-627 E-mail: <a href="mailto:marcom@ixys.de">marcom@ixys.de</a></p>	 An  IXYS Company	<p><b>Westcode Semiconductors Ltd</b> Langley Park Way, Langley Park, Chippenham, Wiltshire, SN15 1GE. Tel: +44 (0)1249 444524 Fax: +44 (0)1249 659448 E-mail: <a href="mailto:WSL.sales@westcode.com">WSL.sales@westcode.com</a></p>	
<p><b>IXYS Corporation</b> 3540 Bassett Street Santa Clara CA 95054 USA Tel: +1 (408) 982 0700 Fax: +1 (408) 496 0670 E-mail: <a href="mailto:sales@ixys.net">sales@ixys.net</a></p>	<p><a href="http://www.westcode.com">www.westcode.com</a></p> <p><a href="http://www.ixys.com">www.ixys.com</a></p>	<p><b>Westcode Semiconductors Inc</b> 3270 Cherry Avenue Long Beach CA 90807 USA Tel: +1 (562) 595 6971 Fax: +1 (562) 595 8182 E-mail: <a href="mailto:WSI.sales@westcode.com">WSI.sales@westcode.com</a></p>	
The information contained herein is confidential and is protected by Copyright. The information may not be used or disclosed except with the written permission of and in the manner permitted by the proprietors Westcode Semiconductors Ltd.			© Westcode Semiconductors Ltd.
In the interest of product improvement, Westcode reserves the right to change specifications at any time without prior notice.			
Devices with a suffix code (2-letter, 3-letter or letter/digit/letter combination) added to their generic code are not necessarily subject to the conditions and limits contained in this report.			

## QUALITY EVALUATION LABORATORY

Rating Report No: 90NR10 (Issue 2)

Date: 4th March, 1993

Origin: Q.E.L.

Pages: 26

### Stud Based Diode SM16-25PCN/R134

Written by: *M. Baker*  
M. Baker

Checked: *M. J. Perry* ; Approved: *DAJ*

The SMxxPCN/R134 series of diffused, fast recovery diodes are based on a 24 mm diameter silicon mounted under spring pressure in a stud base housing.

These diodes are particularly suitable to use in G.T.O. snubber networks.

This supersedes 90NR10 (Issue 1) dated 28.6.90.

#### Ratings

Voltage Grades	:	16-25
$V_{RSM}$	:	1700-2600V
$V_{RRM}$	:	1600-2500V
$I_{F(AV)}$ Single phase: 50 Hz 180° half sinewave; $T_{CASE} = 100^{\circ}C$	:	120A
$I_{F(rms)}$ max.	:	400A
$I_F$ max.	:	400A
$I_{FSM}$ : t = 10ms half sinewave; $T_j$ (initial) = 125°C		
$V_{RM} = 0.6V_{RRM(MAX)}$	:	4250A
$I_{FSM}$ : t = 10ms half sinewave; $T_j$ (initial) = 125°C		
$V_{RM} \leq 10V$	:	4670A
$I^2t$ : t = 10ms $T_j$ (initial) = 125°C; $V_{RM} = 0.6V_{RRM(MAX)}$	:	90.3 x 10 <sup>3</sup> A <sup>2</sup> S
$I^2t$ : t = 10ms; $T_j$ (initial) = 125°C; $V_{RM} \leq 10V$	:	109 x 10 <sup>3</sup> A <sup>2</sup> S
$I^2t$ : t = 3ms; $T_j$ (initial) = 125°C; $V_{RM} \leq 10V$	:	80.6 x 10 <sup>3</sup> A <sup>2</sup> S
$T_{CASE}$ Operating Range	:	-40 to +125°C
$T_{stg}$ : Non-operating	:	-40 to +150°C

R.R. No.	90NR10
R.R. Issue	2
Page Issue	1

Characteristics

(Maximum values unless otherwise stated)

$V_0$ :		: 1.21V
$r_s$ :		: 1.2mohms
A : $T_J = 25^\circ\text{C}$		: 0.5115
B : $T_J = 25^\circ\text{C}$		: 0.2148
C : $T_J = 25^\circ\text{C}$		: $9.468 \times 10^{-4}$
D : $T_J = 25^\circ\text{C}$		: $-2.1073 \times 10^{-2}$
A		: -2.7312
B		: 1.0775
C		: $2.2052 \times 10^{-3}$
D		: -0.1451
$V_{FM}$ at $I_{FM} = 470\text{A}$		: 1.77V
$R_{th(J-C)}$		: 0.13 K/W
$R_{th(C-HS)}$		: 0.04 K/W
$I_{RRM}$ : at $V_{RRM(MAX)}$		: 20mA
$V_{fr}$ : at $dI/dt = 400\text{A}/\mu\text{s}$		: 37V (typical)
Reverse recovery at $I_{FM} = 1\text{KA}; t_p = 200\mu\text{s}$ $di_R/dt = 150\text{A}/\mu\text{s}; V_{RM} = 50\text{V}$		
$Q_{RR}$ (total area)		: $350\mu\text{C}$
$Q_{RA}$ (50% chord)		: $230\mu\text{C}$
$t_{rr}$ (50% chord)		: $2.8\mu\text{s}$ (typical)
$I_{RM}$		: 160A
Mounting Force		: 14Nm
Outline Drawing		: 100A297
JEDEC Outline No.		: -

NOTE: All characteristics are at  $T_{VJ} = T_{Jmax}$  operating unless stated otherwise.

CONTENTS

	<u>Page</u>
Ratings and characteristics	1, 2
Voltage grade table	4
2. <u>Introduction</u>	5
3. <u>Notes on the Ratings</u>	
(a) Square wave ratings	5
(b) Energy per pulse characteristics	5
(c) Housing Loss	5
(d) ABCD constants	5
(e) Reverse Recovery Ratings	5
4. <u>Reverse Recovery Loss</u>	
(a) Determination by Measurement	6
(b) Design Method	6, 7
Limit forward characteristic	8
Transient thermal impedance	9
Surge Rating	10
Forward recovery voltage	11
Recovered charge	12 & 13
Reverse recovery current	14
K factor	15
Reverse recovery energy per pulse	16
Square wave frequency rating 90°C Case 800A/uS	17
Square wave frequency rating 60°C Case 800A/uS	18
Square wave frequency rating 90°C Case 400A/uS	19
Square wave frequency rating 60°C Case 400A/uS	20
Energy per pulse 200A/uS	21
Energy per pulse 400A/uS	22
Sine wave frequency rating 90°C Case	23
Sine wave frequency rating 60°C Case	24
Sine wave energy per pulse	25
Outline drawing	26

Voltage Ratings

Voltage Class	$V_{RRM}$ V	$V_{RSM}$ V
16	1600	1700
18	1800	1900
20	2000	2100
22	2200	2300
24	2400	2500
25	2500	2600

This Report is applicable to higher or lower voltage grades when supply has been agreed by Sales/Production.

## 2.0 Introduction

The diode series comprises fast recovery stud based devices with all diffused silicon slices. All these diodes have controlled reverse recovery characteristics with good "K" factors. These diodes are particularly suitable for use in G.T.O. and SCR snubber networks.

## 3.0 Notes on the Ratings

### (a) Square wave ratings

These ratings are given for leading edge linear rates of rise of forward current of 400 and 800A/uS.

### (b) Energy per pulse characteristics

These curves enable rapid estimation of device dissipation to be obtained for conditions not covered by the frequency ratings.

Let:  $E_p$  be the Energy per pulse for a given current and pulse width in joules, and  $f$  be the repetition rate

$$\text{Then } W_{AV} = E_p \times f$$

$$T_{CASE} = T_{J(MAX)} - E_p \times f \times R_{th}$$

### (c) Housing Loss

The loss caused by coupling between housing and anode current (which gives rise to additional heating at high frequency) has been incorporated into the curves of forward energy loss per pulse.

### (d) ABCD Constants

These constants are the co-efficients of the semi-empirical expression for the forward characteristic given below:

$$V_F = A + B \ln I_F + C I_F + D \sqrt{I_F}$$

### (e) Reverse recovery ratings

(i)  $Q_{ra}$  is based on 50%  $I_{rm}$  chord as shown below

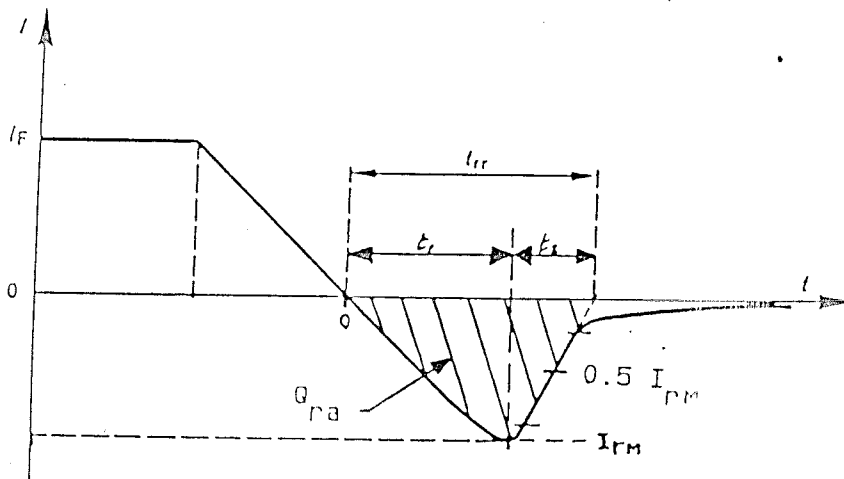

(ii)  $Q_{rr}$  is based on a 150 uS integration time

$$\text{i.e. } Q_{rr} = \int_{t=0}^{150\mu\text{S}} I_r \cdot dt$$

(iii) K factor =  $t_1/t_2$

#### 4.0 Reverse Recovery Loss

The following procedure is recommended for use where it is necessary to include reverse recovery loss.

##### (i) Determination by measurement

From waveforms of recovery current obtained from a high frequency shunt (see Note 1) and reverse voltage present during recovery, an instantaneous reverse recovery loss waveform must be constructed. Let the area under this waveform be A joules per pulse. A new case temperature can then be evaluated from:

$$T_{\text{CASE}}(\text{new}) = T_{\text{CASE}}(\text{original}) - A \left( \frac{r_t \cdot 10^6}{t} + R_{\text{th}} \times f \right)$$

$$\text{where } r_t = 1.77 \times 10^{-4} \cdot \sqrt{t}$$

t = duration of reverse recovery loss per pulse in microseconds

A = Area under reverse loss waveform per pulse in joules (W.S.)

f = rated frequency at the original case temperature

The total dissipation is now given by

$$W_{(\text{TOT})} = W_{(\text{original})} + A \times f$$

#### NOTE 1

##### Reverse Recovery Loss by Measurement

This device has a low reverse recovered charge and peak reverse recovery current. When measuring the charge care must be taken to ensure that:

- (a) a.c. coupled devices such as current transformers are not affected by prior passage of high amplitude forward current.
- (b) The measuring oscilloscope has adequate dynamic range - typically 100 screen heights - to cope with the initial forward current without overload.
- (c) Measurement of reverse recovery waveform should be carried out with an appropriate snubber of 0.1uF, 5ohms connected across diode anode to cathode.

##### (ii) Design Method

In circumstances where it is not possible to measure voltage and current conditions, or for design purposes, the additional losses may be estimated from curves on pages 16.

Let E be the value of energy per reverse cycle in joules (curves on page 16).

Let f be the operating frequency in Hz

Then  $T_{\text{CASE}}(\text{new}) = T_{\text{CASE}} \text{ original} - E \times R_{\text{th}} \times f$

Where  $T_{\text{CASE}}(\text{new})$  is the required maximum case temperature and  $T_{\text{CASE}} \text{ original}$  is the case temperature given with the frequency ratings.



FORWARD CHARACTERISTIC OF LIMIT DEVICE

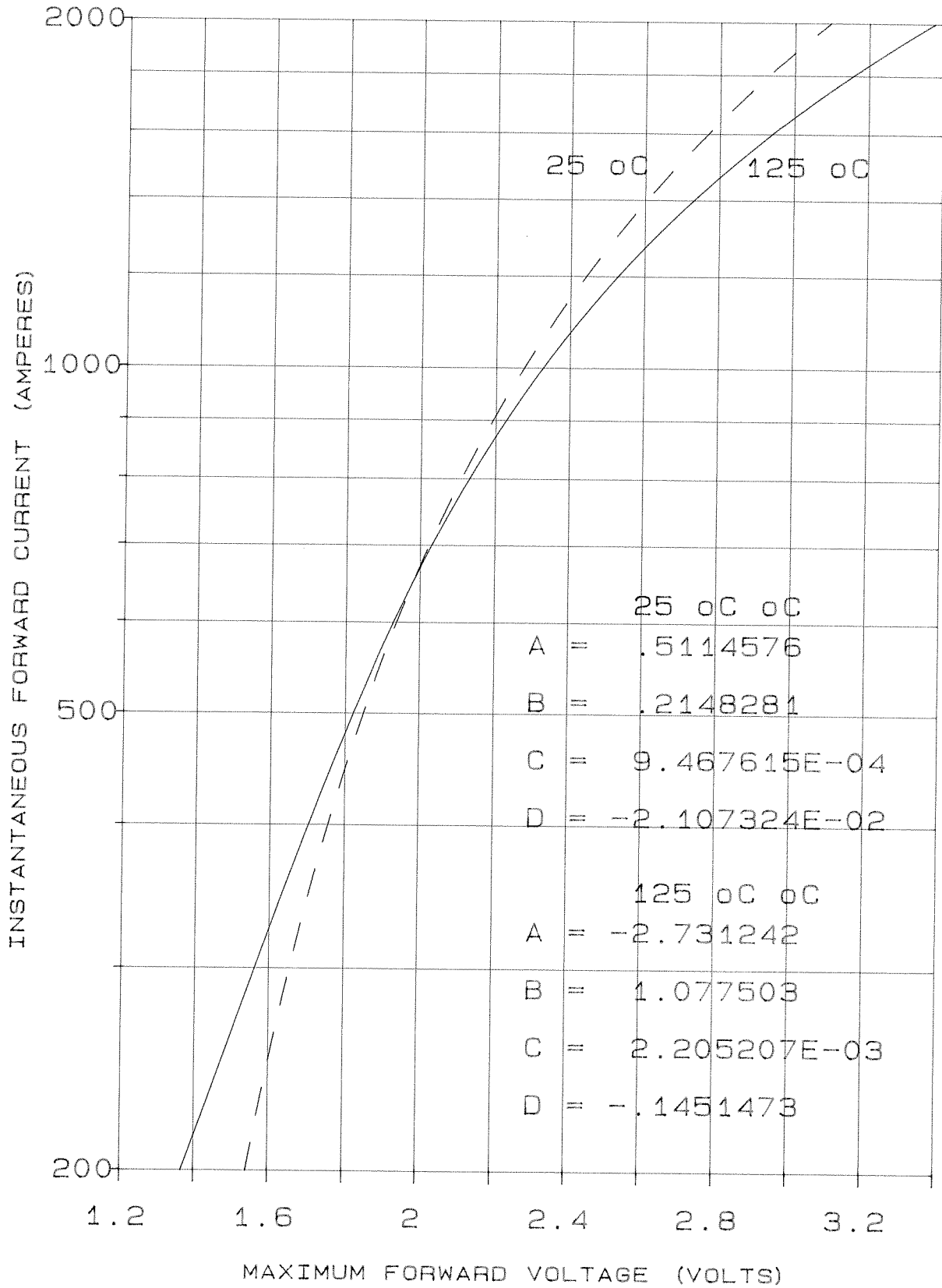

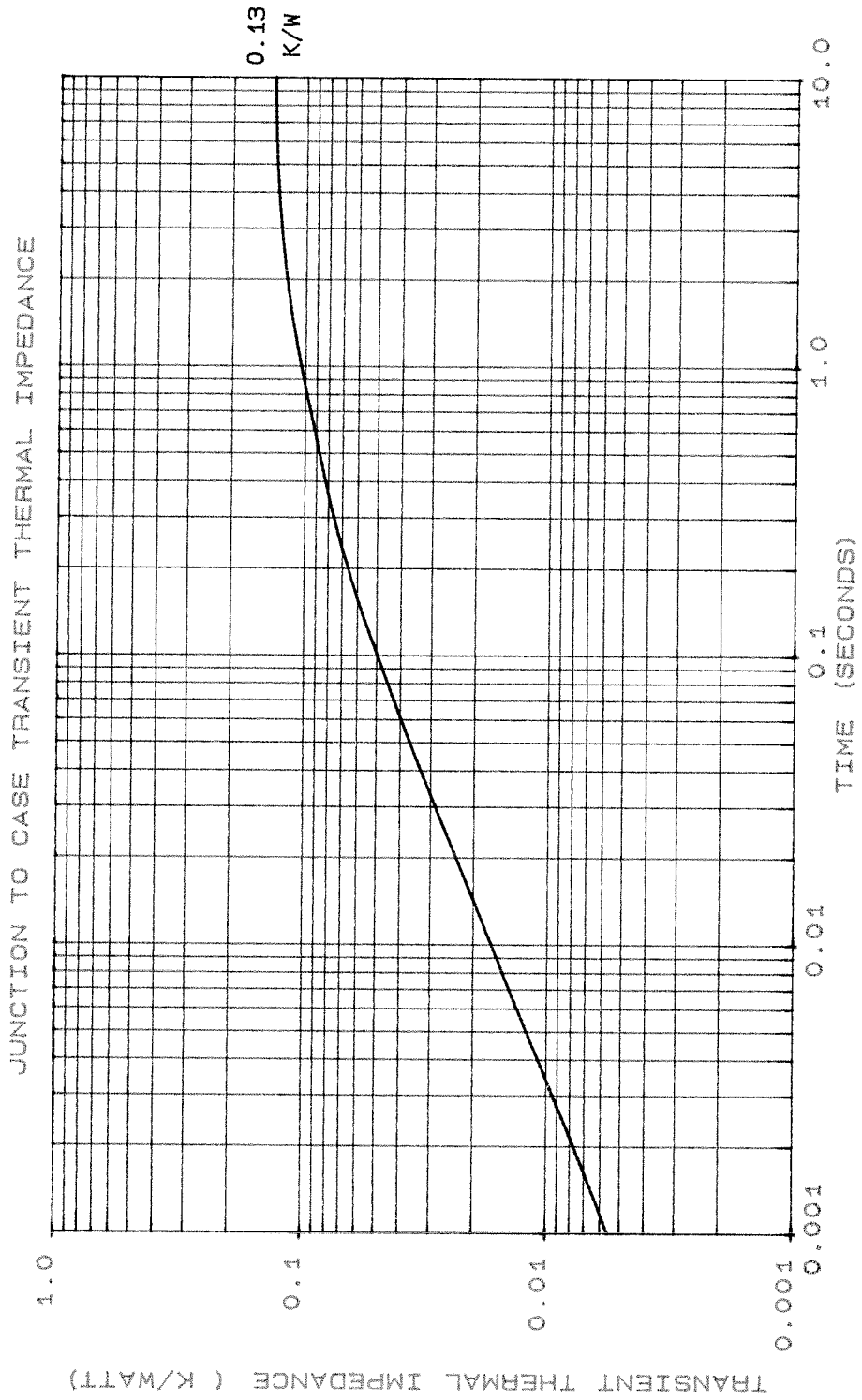

MAXIMUM NON REPETITIVE SURGE CURRENT AT INITIAL JUNCTION TEMPERATURE 125°C

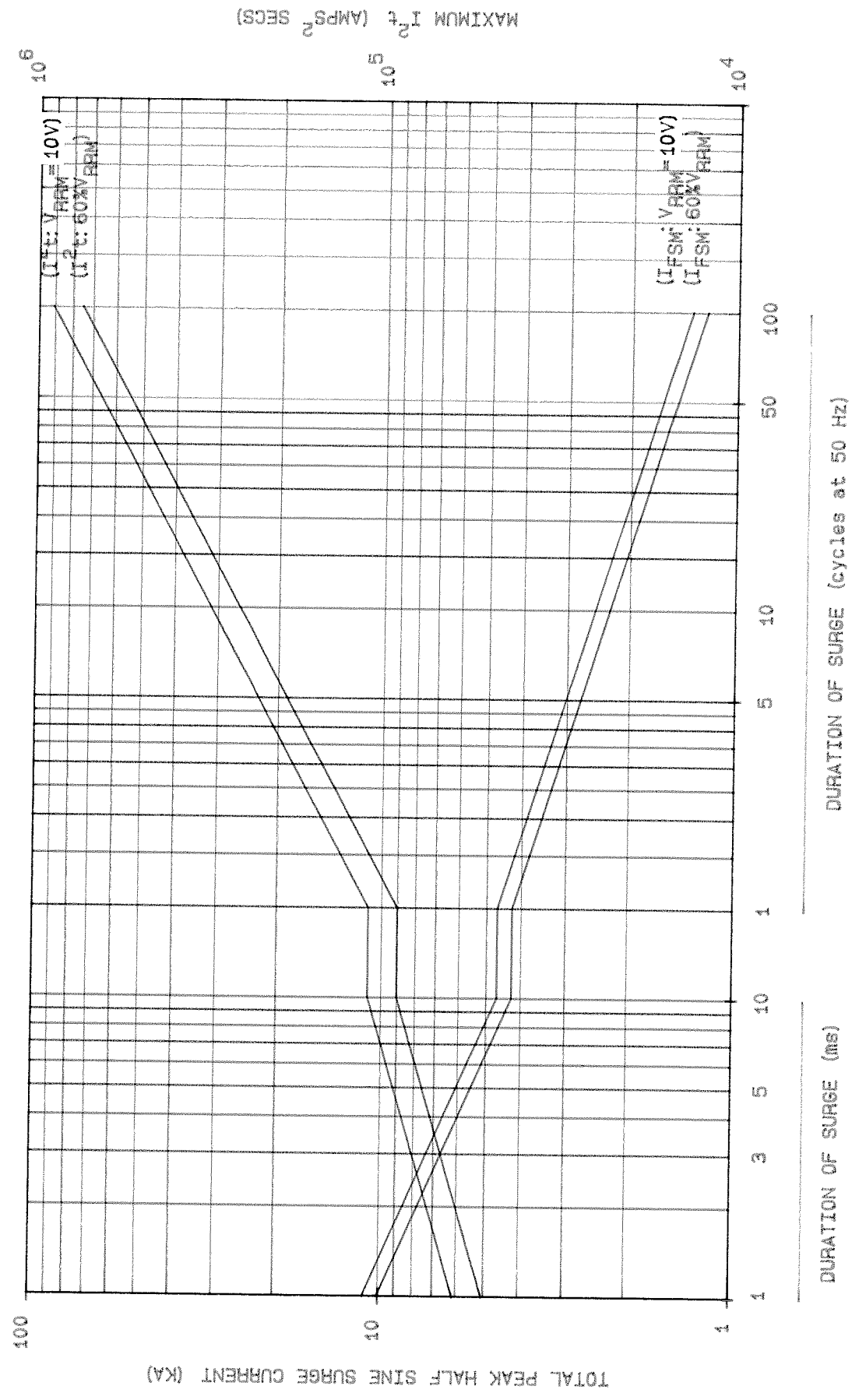

TYPICAL FORWARD RECOVERY VOLTAGE

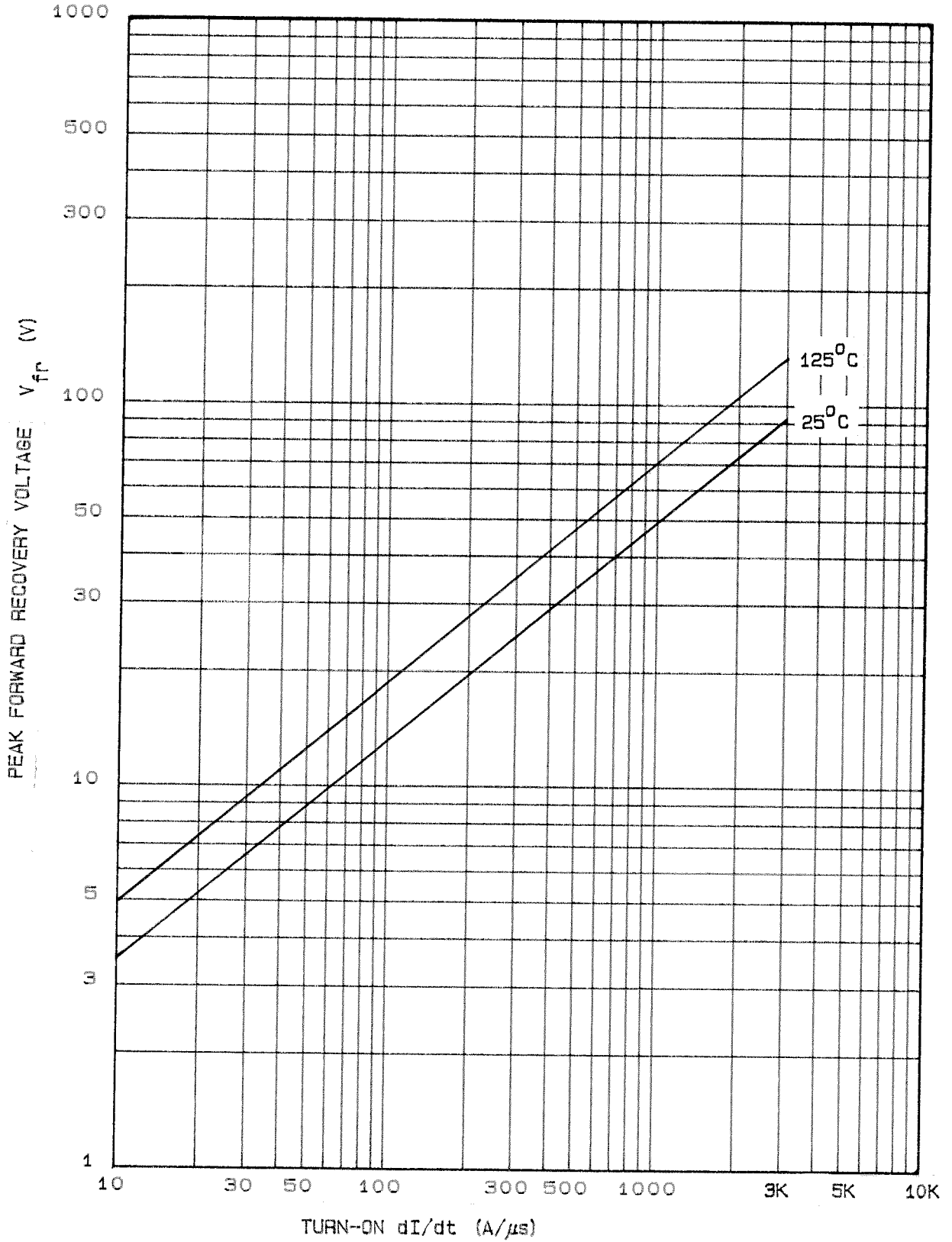

MAXIMUM RECOVERED CHARGE AT 125°C JUNCTION TEMPERATURE

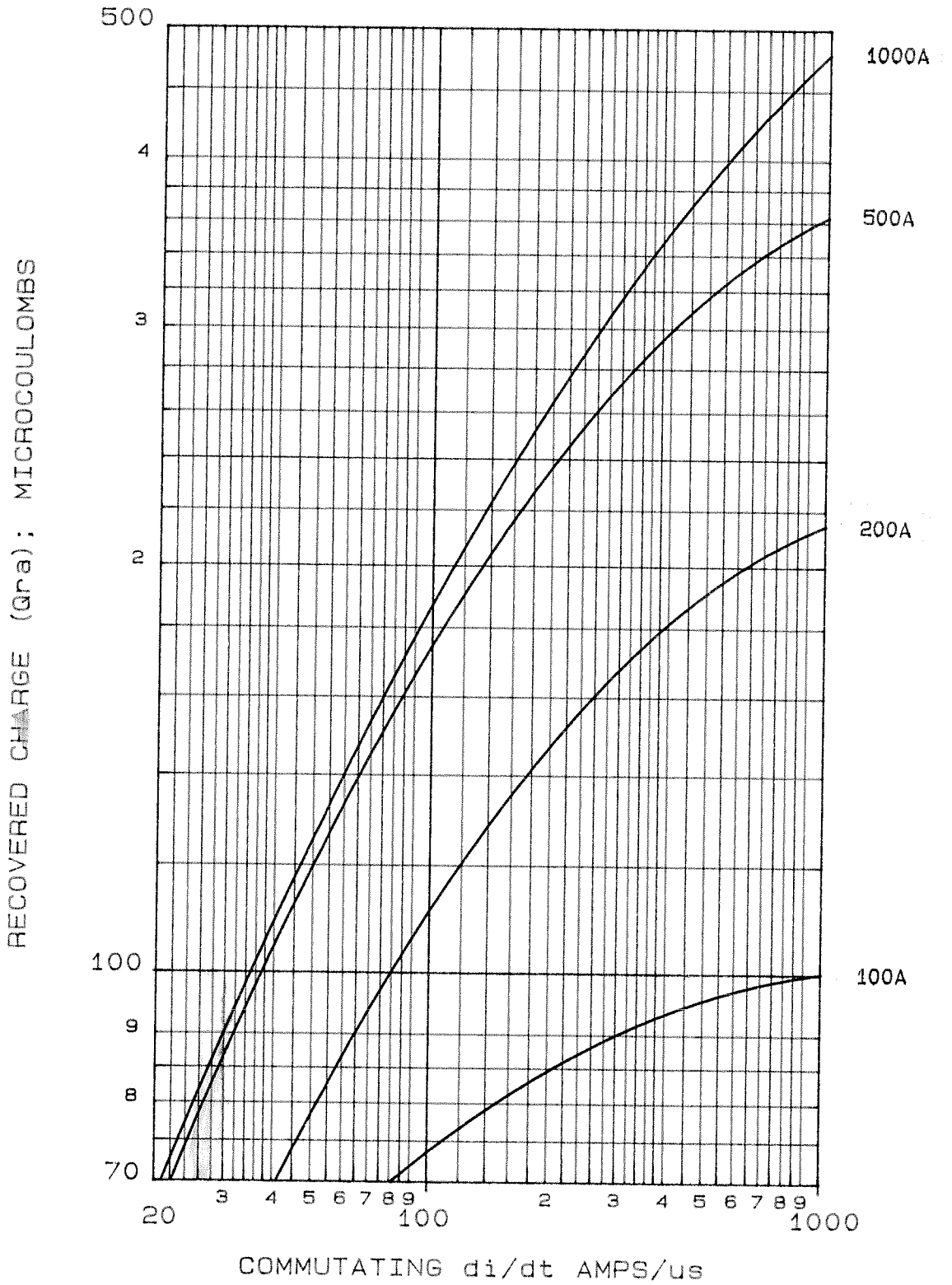

MAXIMUM REVERSE RECOVERY CURRENT  
AT 125°C JUNCTION TEMPERATURE

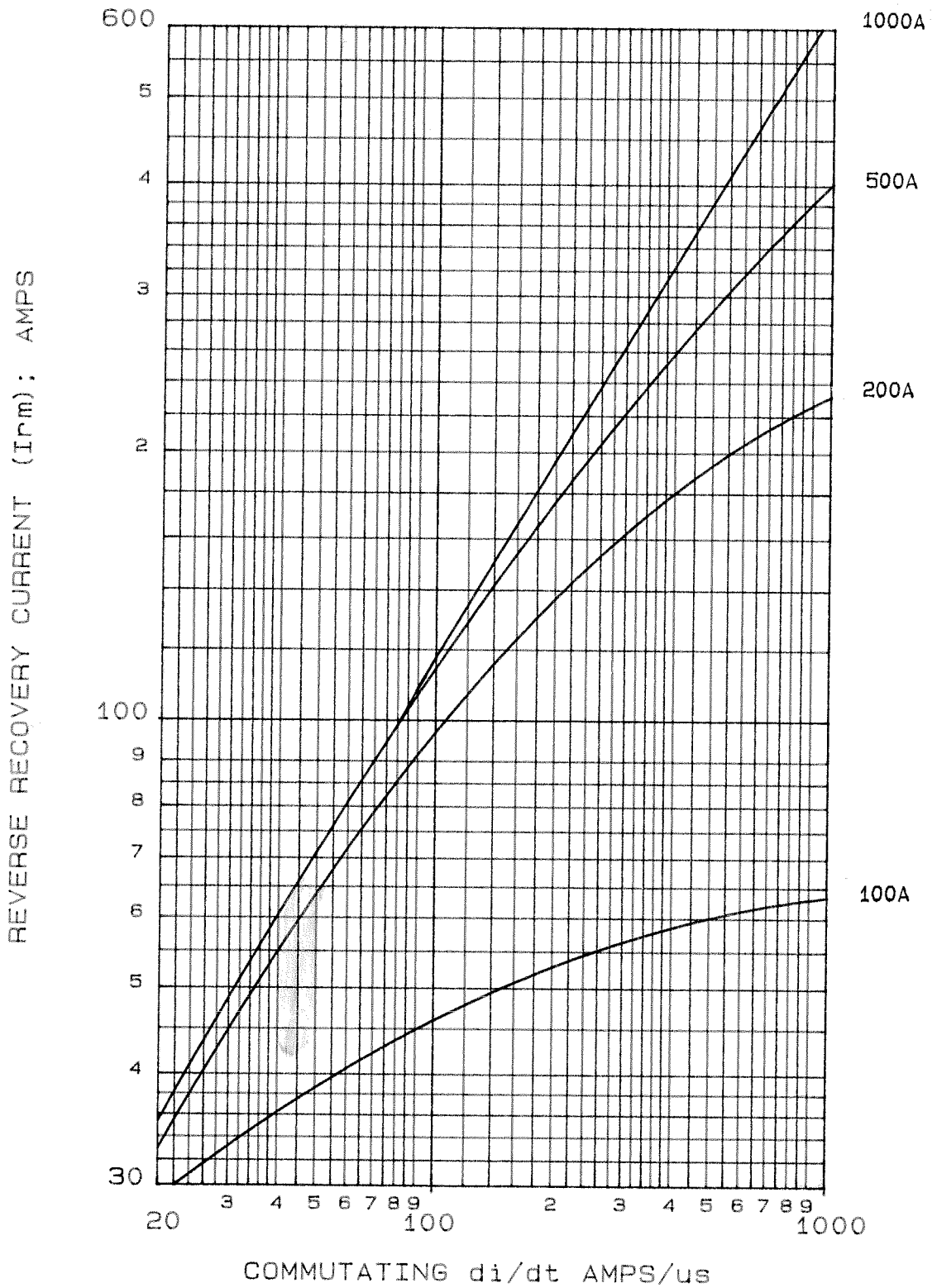

MAXIMUM K FACTOR

$T_j = 125^{\circ}\text{C}$

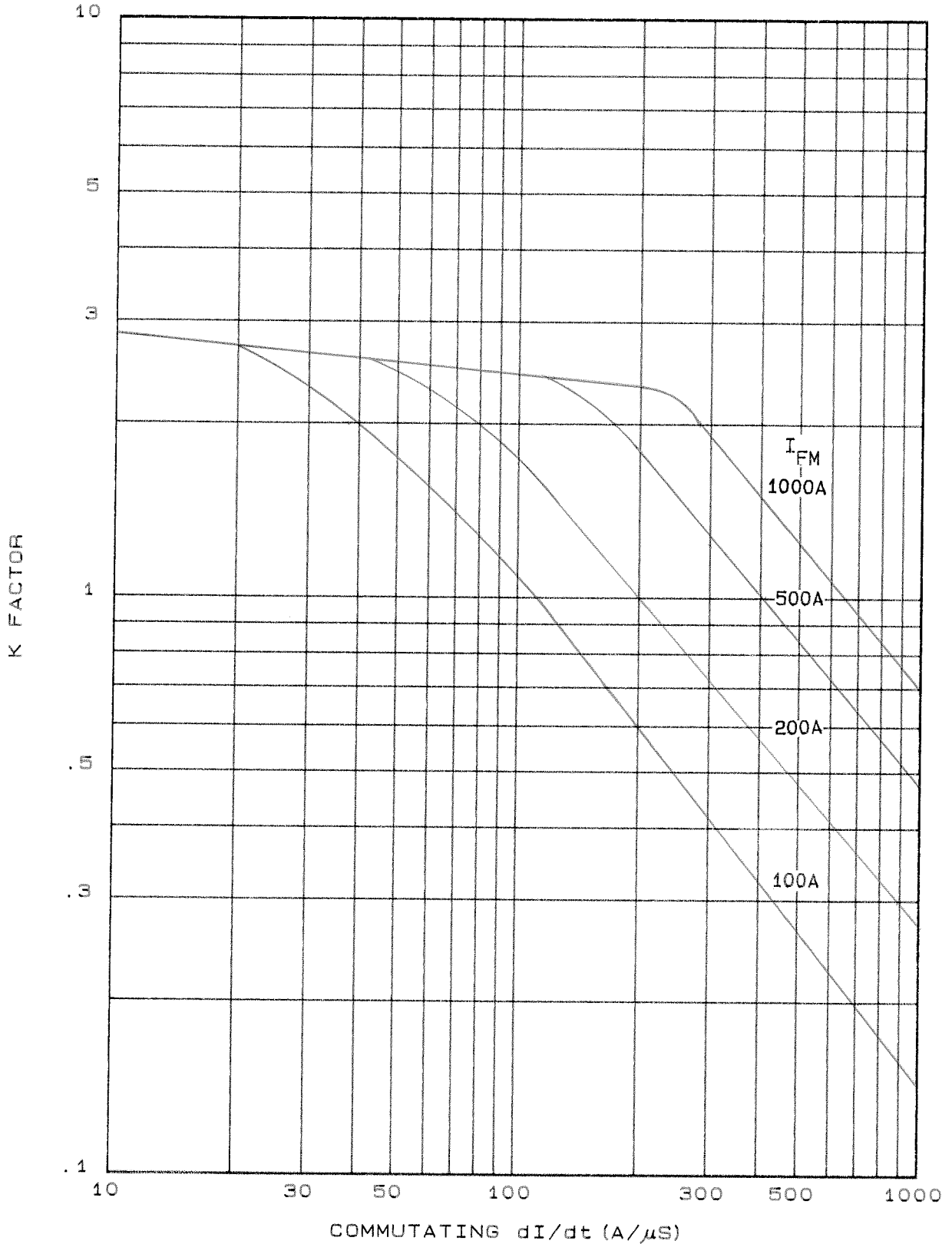

MAXIMUM REVERSE RECOVERY ENERGY LOSS PER PULSE, 125 C JUNCTION TEMPERATURE

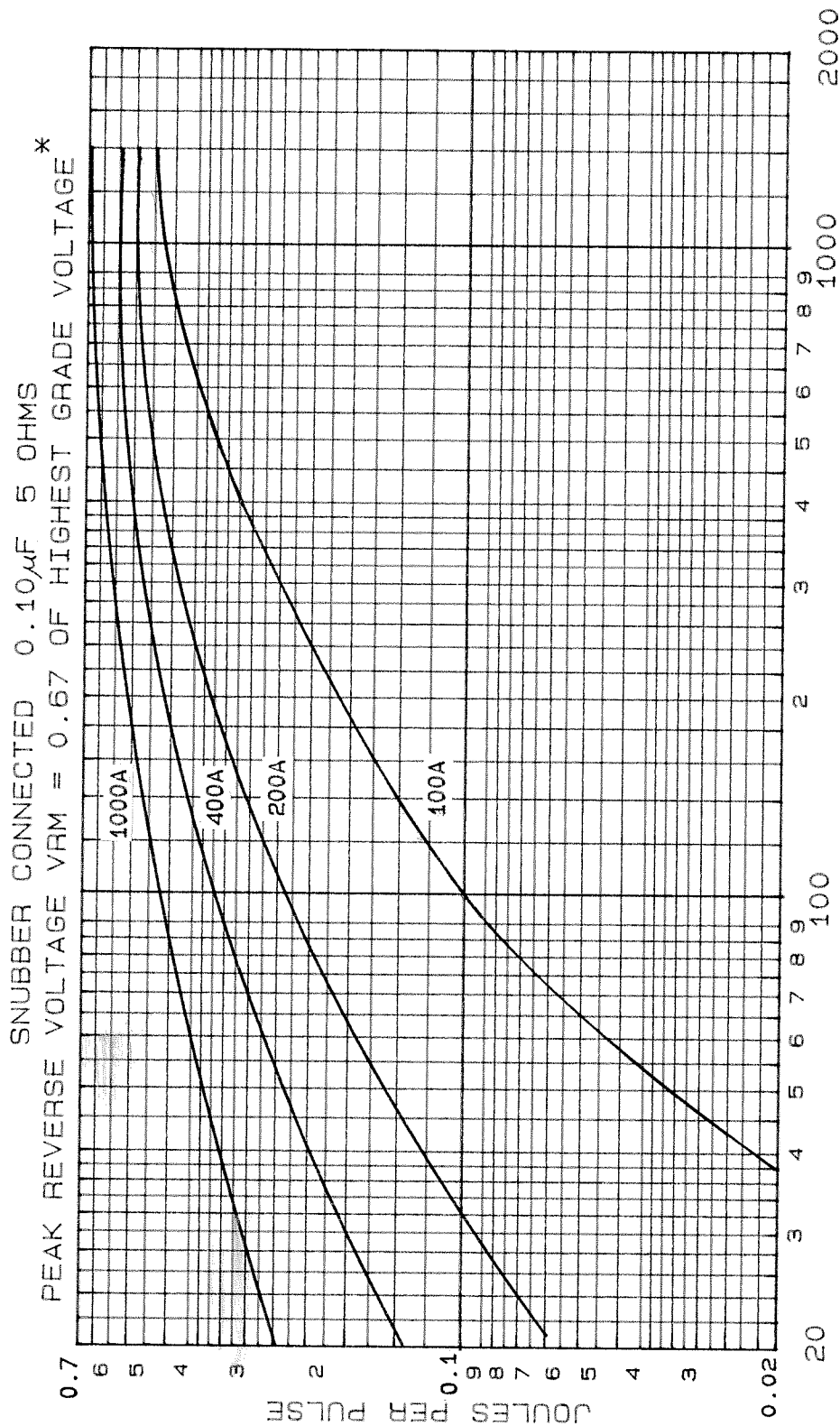

COMMUTATING di/dt AMPS/US

\* NOTE: ENERGY PER PULSE SHOULD BE ADJUSTED PRO RATA WITH APPLIED PEAK RECOVERY VOLTAGE



T BASE 90°C 800A/μs

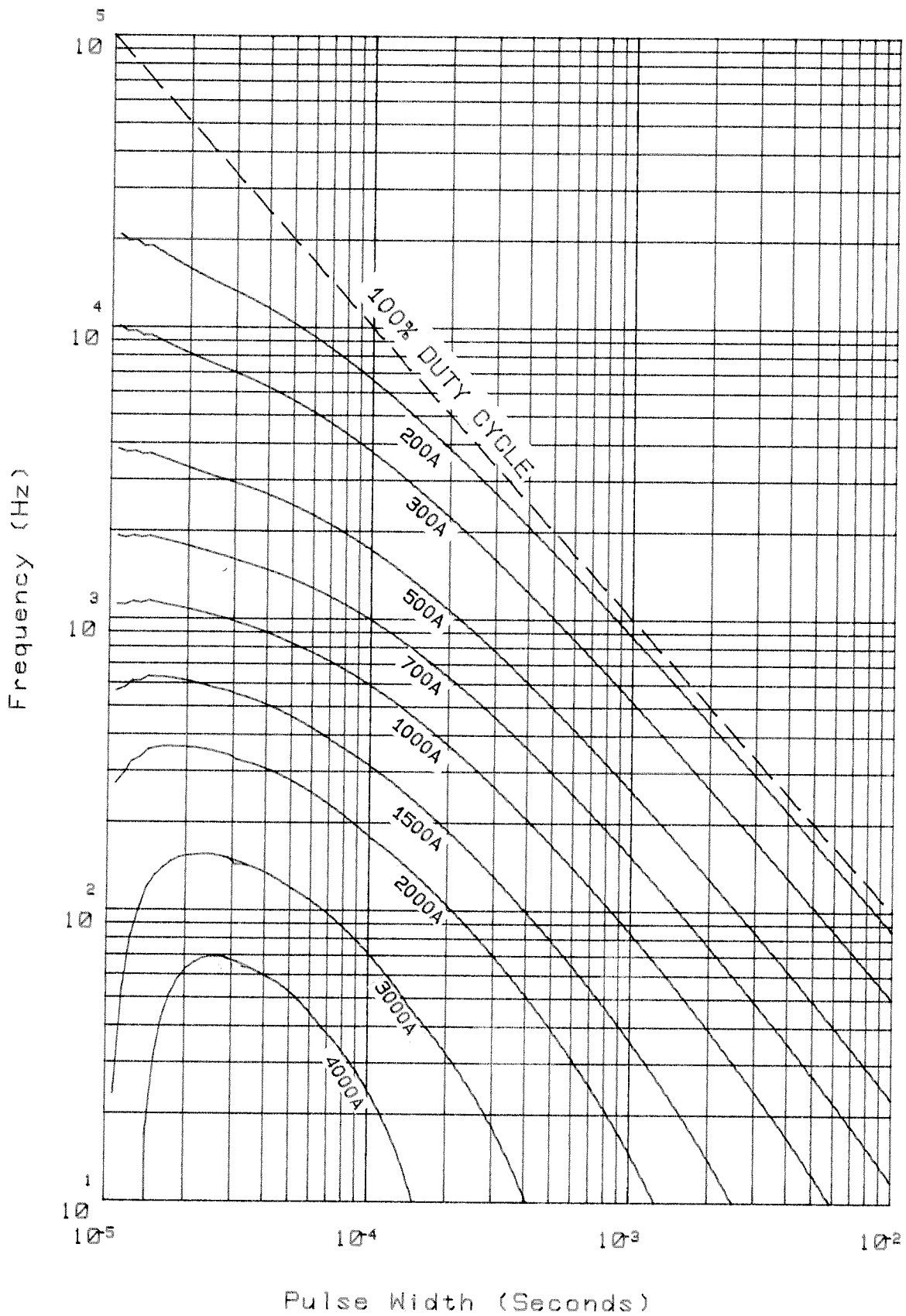

T BASE 60 °C. 800A/ $\mu$ s

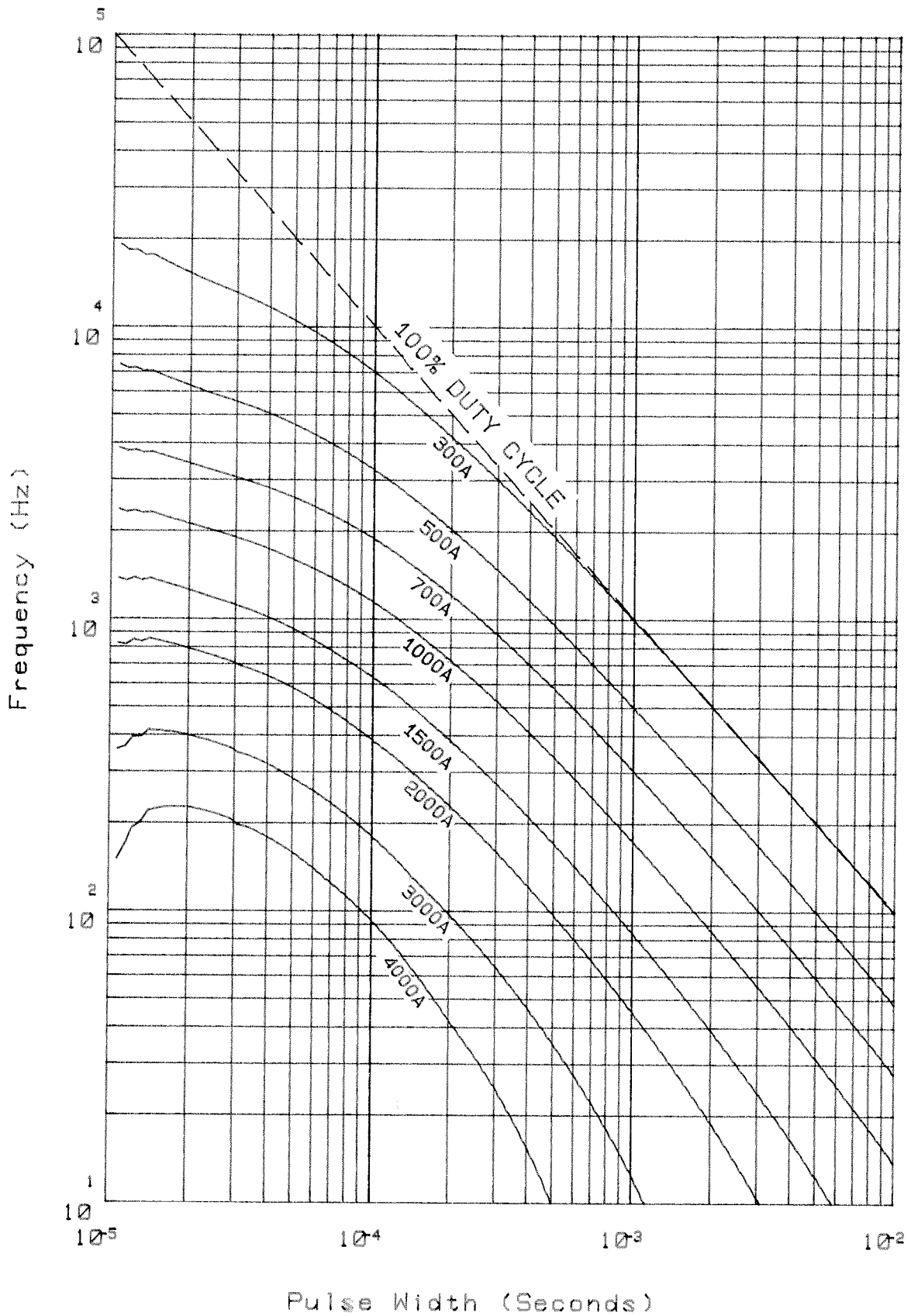

T BASE 90 °C. 400A/ $\mu$ s

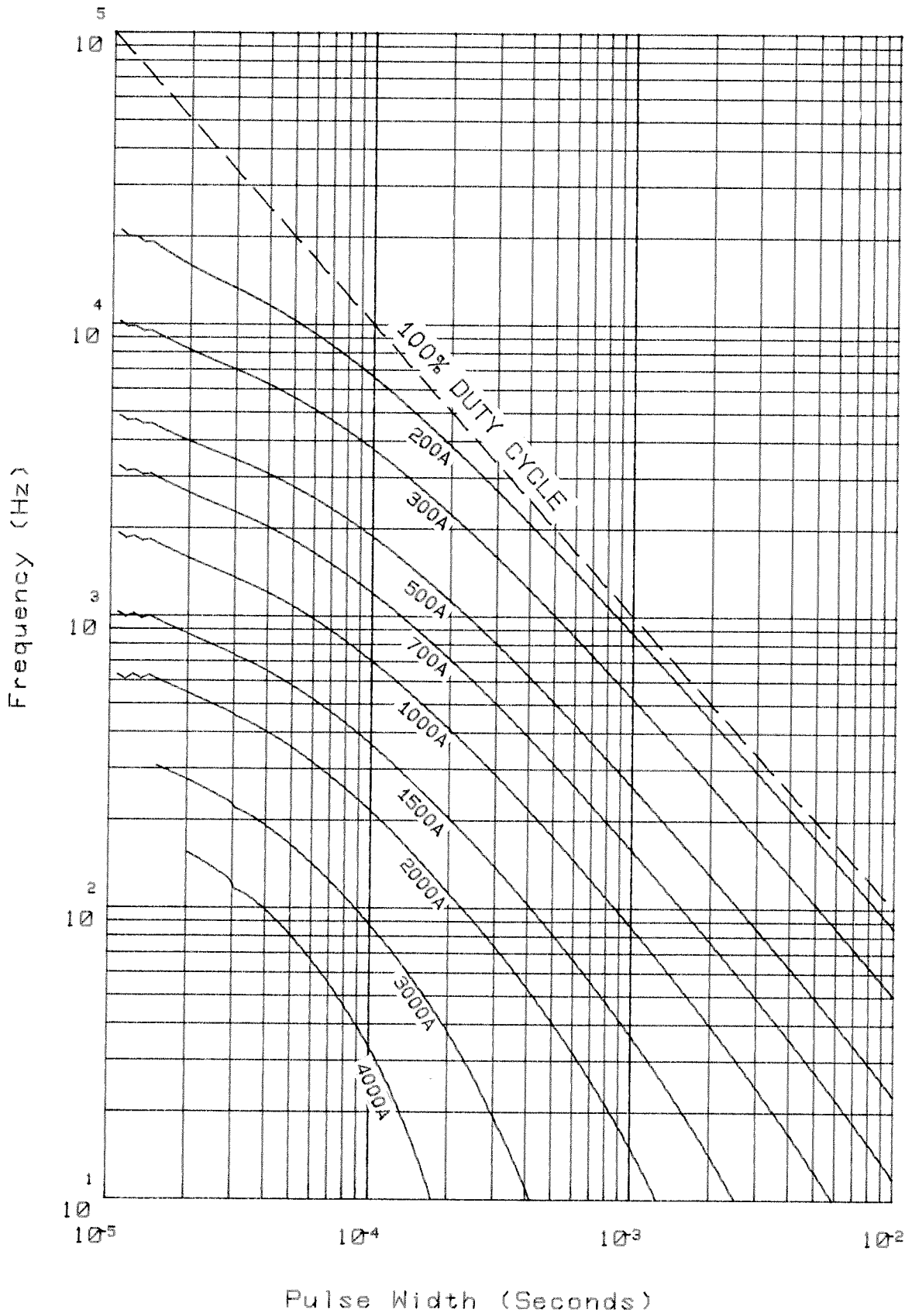

T BASE 60 °C. 400A/ $\mu$ s

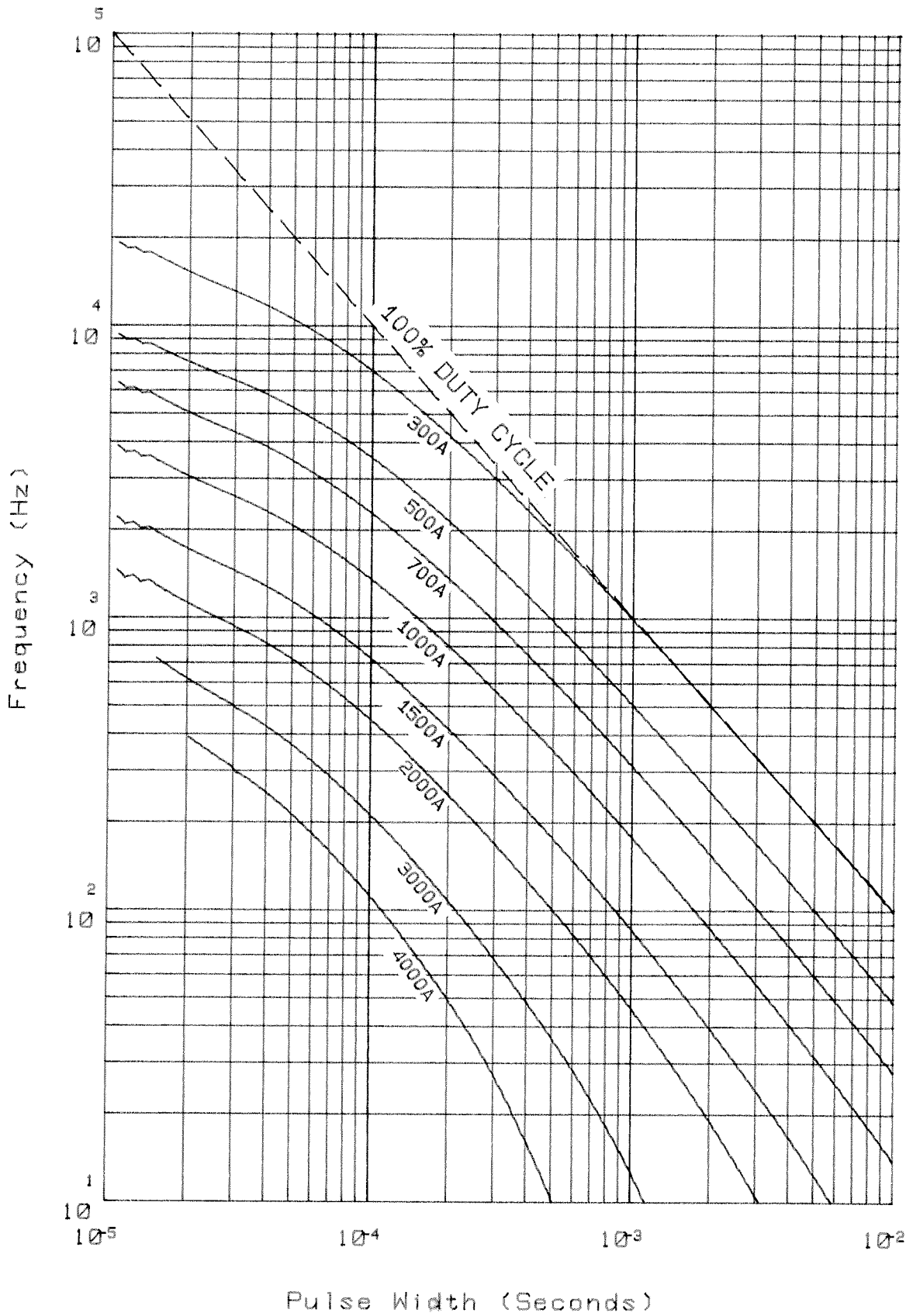

T<sub>j</sub> 125 °C. 800A/μs

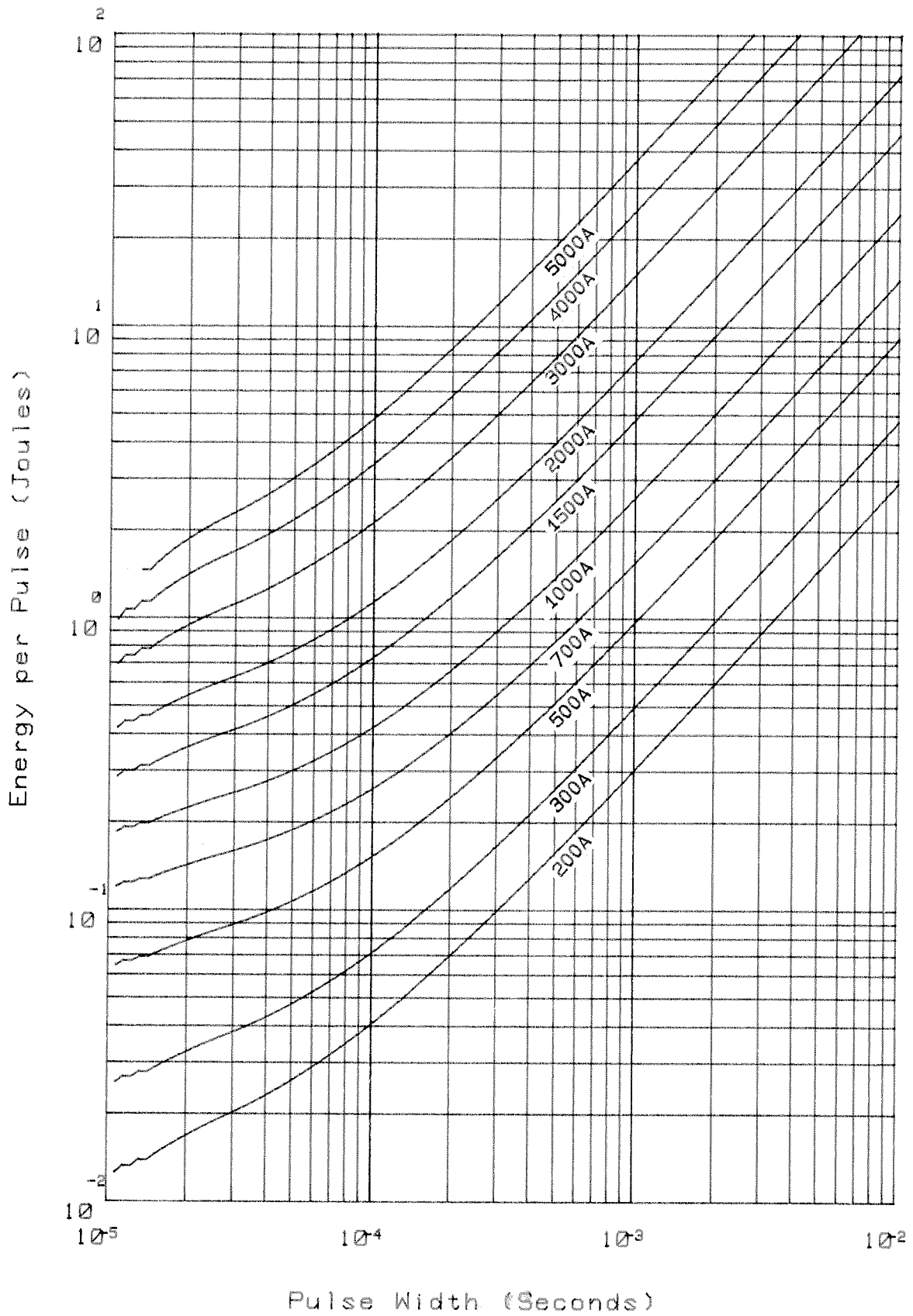

Tj 125 °C. 400A/μs

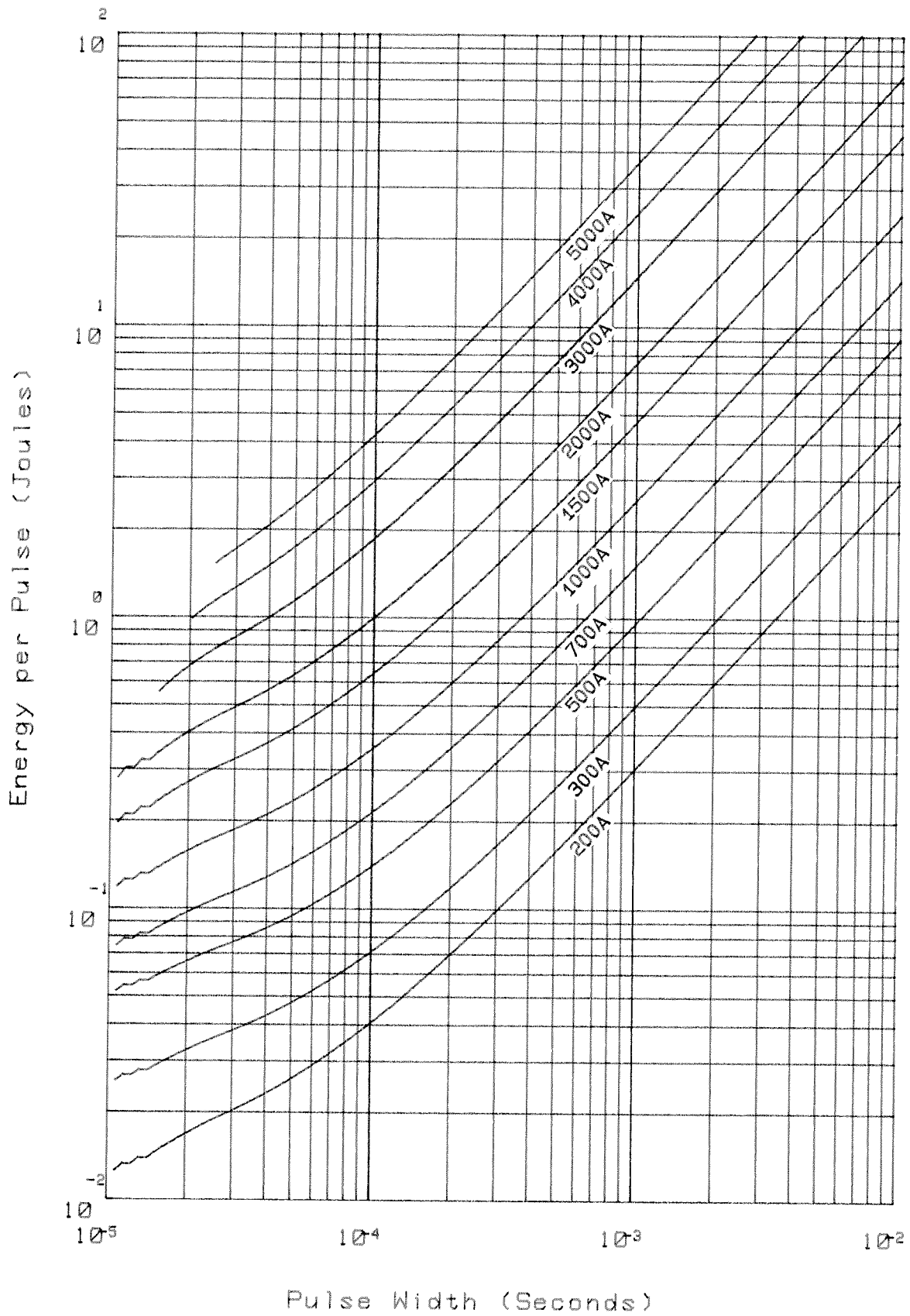

T BASE 90 °C SINE WAVE

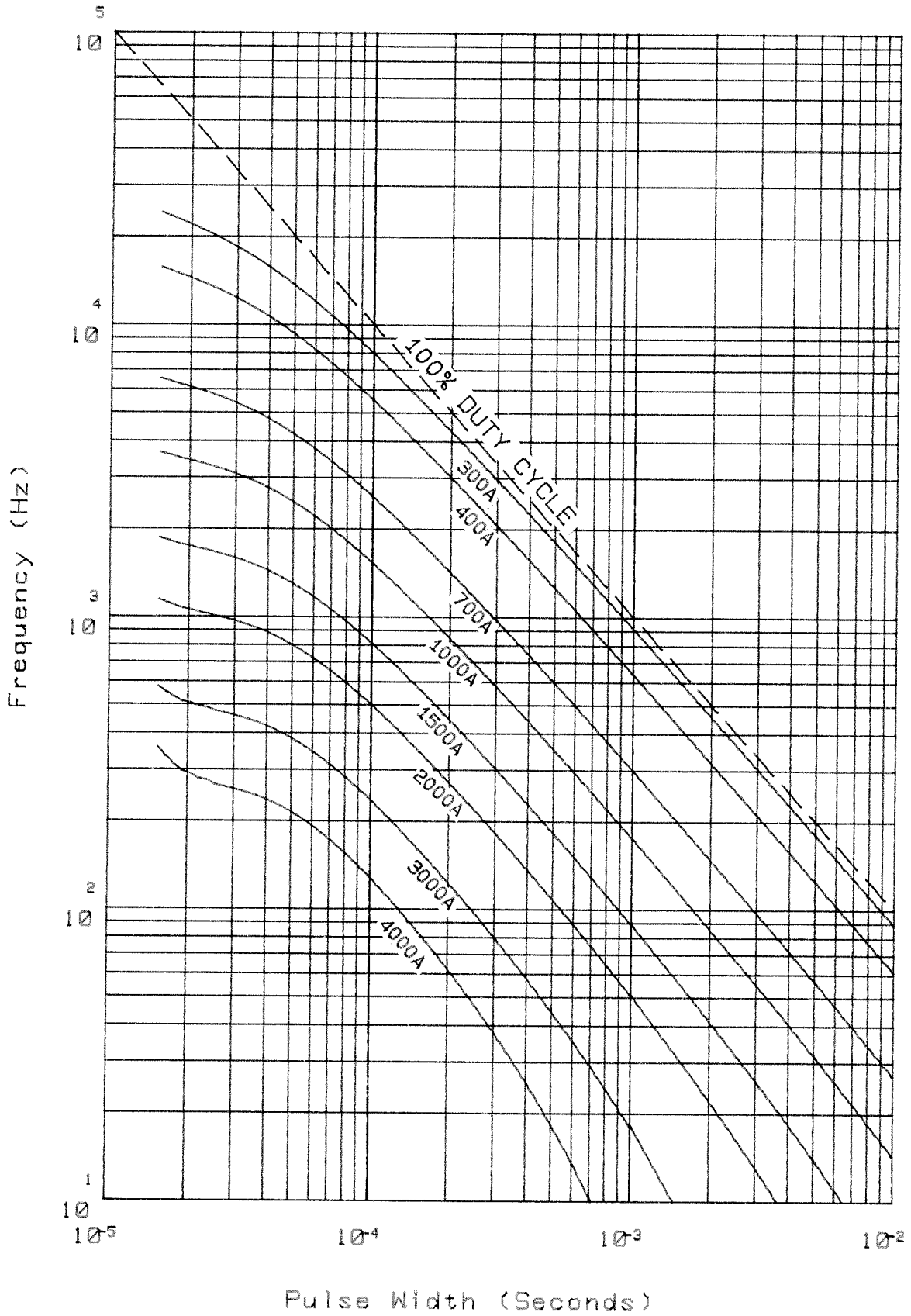

T BASE 60 °C SINE WAVE

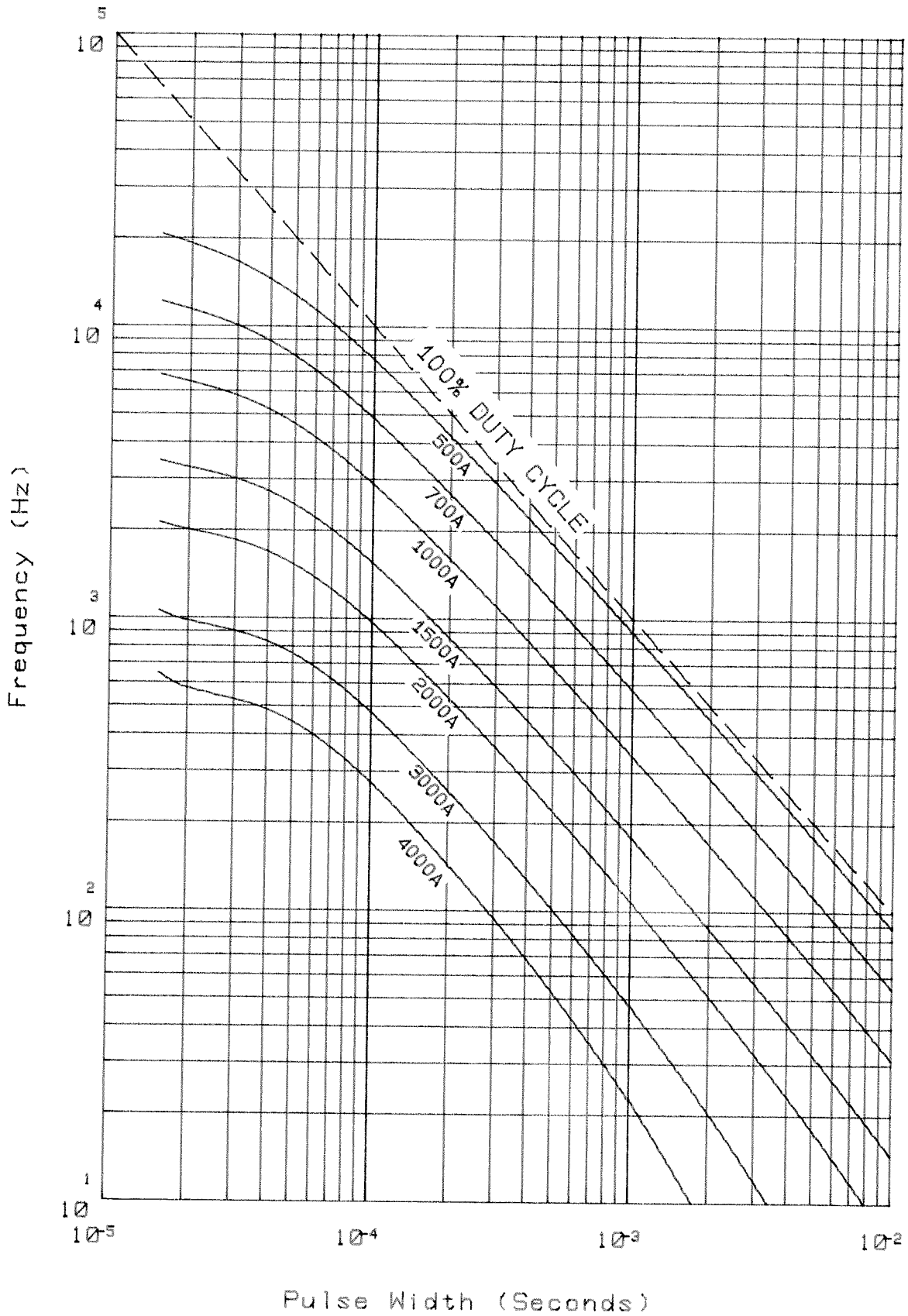



Tj 125 °C SINE WAVE

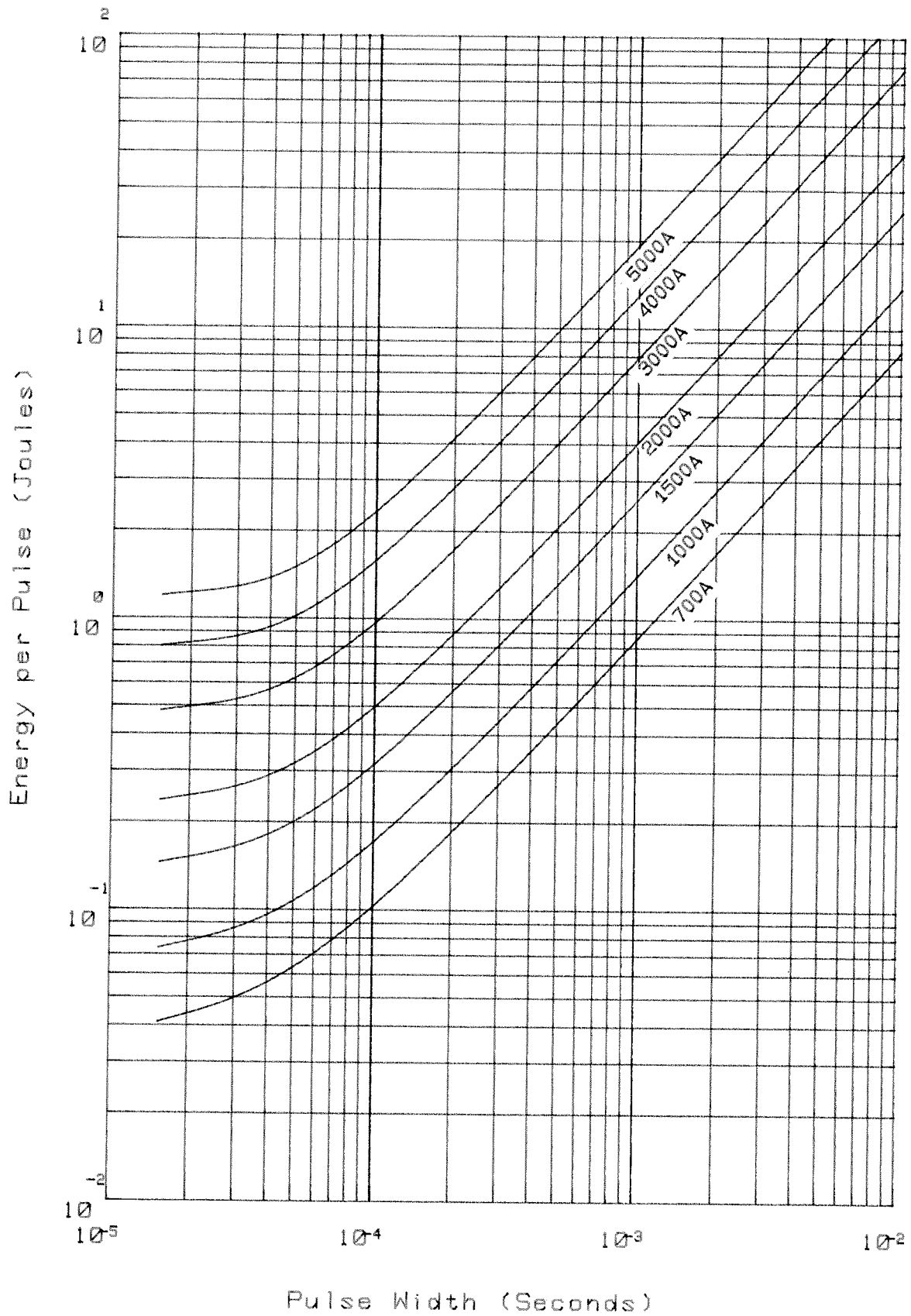

SCALE	1/1
DRN	AWF
CHKD	
APPD	
	A
S	NI

INTERNATIONAL OUTLINE No.  
 WEIGHT. 200 GRAMS - 26 -  
 FINISH. BRIGHT NICKEL PLATE.  
 DEVICE MARKING INCLUDES MONOGRAM, TYPE No., SPEC.  
 No. AND POLARITY SYMBOL  
 DEVICE MOUNTING: MOUNTING TORQUE  
 TO BE 14 Nm (1.45 kgf-m).  
 THREADS MUST NOT BE LUBRICATED.

**DIODE** TYPE NUMBER  
 PCN144 PCR144  
 PCN134 PCR134  
*Not repeated  
 same issue as in  
 Report 3.*

G.A. DRG. No. 102A231N & 102A231R.

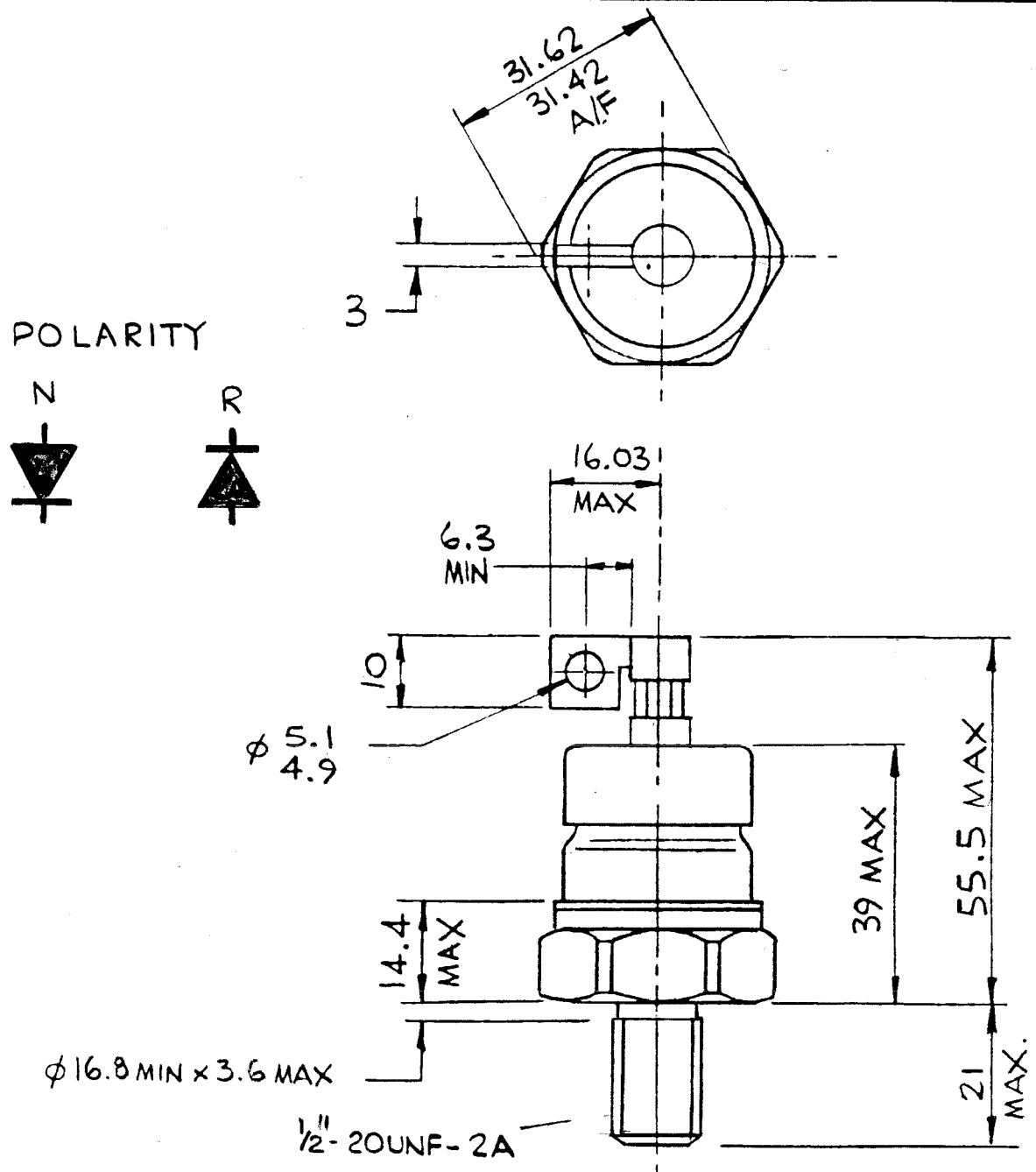

THE INFORMATION CONTAINED IN THIS DRAWING IS SUPPLIED IN CONFIDENCE AND IS NOT TO BE REPRODUCED OR TRANSMITTED IN ANY FORM OR BY ANY MEANS, ELECTRONIC OR MECHANICAL, INCLUDING PHOTOCOPYING, RECORDING, OR BY ANY INFORMATION STORAGE AND RETRIEVAL SYSTEM, WITHOUT THE WRITTEN PERMISSION OF WESTINGHOUSE BRAKE AND SIGNAL CO. LTD.

WESTINGHOUSE BRAKE AND SIGNAL CO. LTD.  
 CHIPPENHAM, WILTSHIRE, SN15 1JD, ENGLAND.

WESTCODE® SEMICONDUCTORS  
 THIRD ANGLE PROJECTION  
  
 DIMNS. IN MILLIMETRES  
 DRG. No. 100A297

ISS	REVISIONS
1	28.11.88.
2	9.1.89 1/2"-20UNF WAS 1/4"-16UNF AWF
3	12.1.89 TYPE No. WAS PRN/R144AWF
4	24.1.90 TYPE No WAS PRN/R144 U9143 AWF
5	PCN/R134 ADDED. 21.5.90 AWF