

T-52-13-07

**Monolithic Integrated Circuits**

**Application:** To drive LED-displays with 5 or 10 diodes

**Features:**

- Wide supply voltage range
- High LED current
- Low power dissipation due to series connection of LED's
- Different colour LED's can be connected arbitrary
- No peripheral components are necessary
- High input resistance
- Eligible between:
  - 5 LED's line with linear scale division with U 237 BG or U 247 BG
  - 5 LED's line with logarithmic scale division with U 257 BG or U 267 BG
  - 10 LED's line with linear scale division with U 237 BG and U 247 BG
  - 10 LED's line with logarithmic scale division with U 257 BG and 267 BG

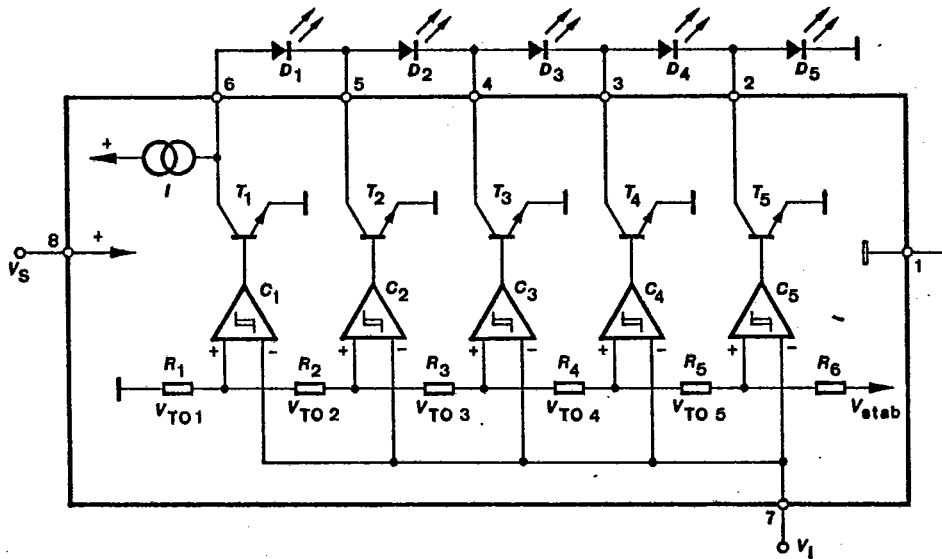

852447 8

Fig. 1 Block diagram LED scale IC

T1.2/1310.0386 E1

0364

E-09

227

U 237 BG · U 247 BG

U 257 BG · U 267 BG

T-52.13-07

## Absolute maximum ratings

Supply voltage	$V_S$	25	V
Input voltage	$V_I$	5	V
Input current	$I_I$	0.5	mA
Output current, maximum	$I_{O1.5}$	30	mA
Output reverse voltage	$V_O$	$V_S$	
Power dissipation $T_{amb} = 60^\circ\text{C}$	$P_{tot}$	690	mW
Ambient temperature range			
$V_S = 25\text{ V}$	$T_{amb}$	-10...+60	$^\circ\text{C}$
$V_S = 18\text{ V}$	$T_{amb}$	-10...+85	$^\circ\text{C}$
Storage temperature range	$T_{stg}$	-15...+125	$^\circ\text{C}$
Junction temperature	$T_j$	150	$^\circ\text{C}$

## Thermal resistance

		Min.	Typ.	Max.	
Junction ambient	$R_{thJA}$			130	K/W

## Optical and electrical characteristics

 $V_S = 16\text{ V}$ ,  $T_{amb} = 25^\circ\text{C}$ , Reference point: Ground

Total current (incl. LED current)	$I_S$		25		mA
Supply voltage	$V_S$	12		25	V
Step tolerance	$\Delta V_I$			$\pm 30$	mV
Switching threshold hysteresis	$\Delta V_{IH}$		10		mV
Input current	$-I_I$		1		$\mu\text{A}$
Output saturation voltage $I_{O1.5} = 20\text{ mA}$	$V_{O1.5sat}$			1.1	V
Output current	$-I_{OS}$		20		mA

0365 E-10

**U 237 BG · U 247 BG**  
**U 257 BG · U 267 BG**

(T-52-13-07)

**Circuit description**

The IC's are driving circuits for a 5 or 10 LED bar display having an integrated current generator whose current is adjusted to 20 mA.

Light emitting diodes are connected in series in order to reduce power dissipation and to have the same current flow to the supply in every operating condition, Fig. 2

For red LED's (i.e. TLSR 5100) the supply voltage is 12 V whereas in case of green or yellow diodes (i.e. TLSY 5100, TLSG 5100) the voltage is 16 V.

The input thresholds are:

**U 237 BG:** 0.2 V, 0.4 V, 0.6 V, 0.8 V, 1.0 V

**U 247 BG:** 0.1 V, 0.3 V, 0.5 V, 0.7 V, 0.9 V

**U 257 BG:** 0.18 V/-15 dB, 0.5 V/-6 dB, 0.84 V/-1.5 dB, 1.19 V/+1.5 dB, 2.0 V/+6 dB

**U 267 BG:** 0.1 V/-20 dB, 0.3 V/-10 dB, 0.71 V/-3 dB, 1.0 V/0 dB, 1.41 V/+3 dB

If a voltage greater than the first threshold but less than the second threshold is applied one LED is lighted, if the input voltage is between the second and the third threshold, then two LED's are in operation and so on.

Fig. 2 shows the circuit diagram of a bar display with 5 LED's.

By choosing a parallel connection of the inputs of an U 237 BG and an U 247 BG it is possible to get a 10 LED bar display with thresholds 0.1 V, 0.2 V, 0.3...1.0 V.

By choosing a parallel connection of the inputs of an U 257 BG and an U 267 BG it is possible to get a 10 LED bar display with thresholds: -20 dB, -15 dB, -10 dB...+6 dB.

Fig. 3 shows the circuit diagram of a bar display with 10 LED's.

**Applications:**

Fig. 2 Bar display with 5 LED's

U 237 BG · U 247 BG  
U 257 BG · U 267 BG

T-52-13-07

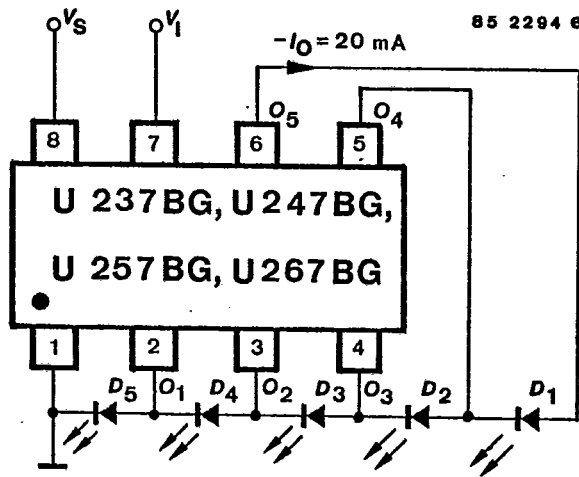
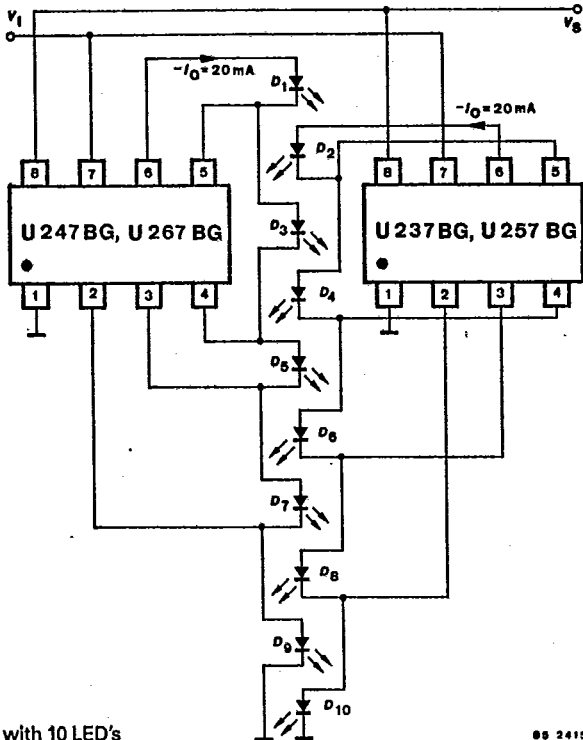

Fig. 3 Bar display with 10 LED's

88 2415 ●

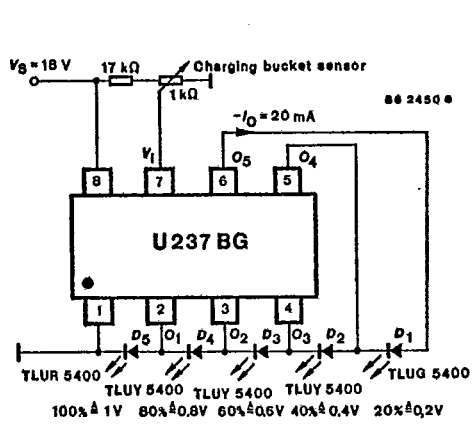

Fig. 4 Liquid level display with linear resistance pickup

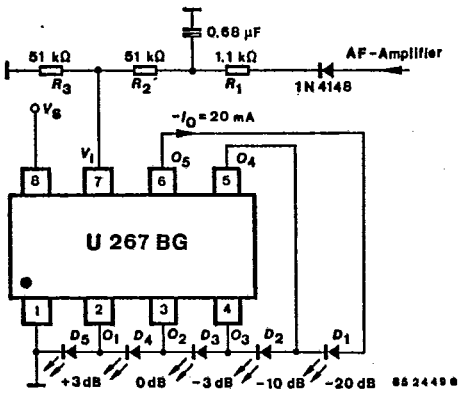
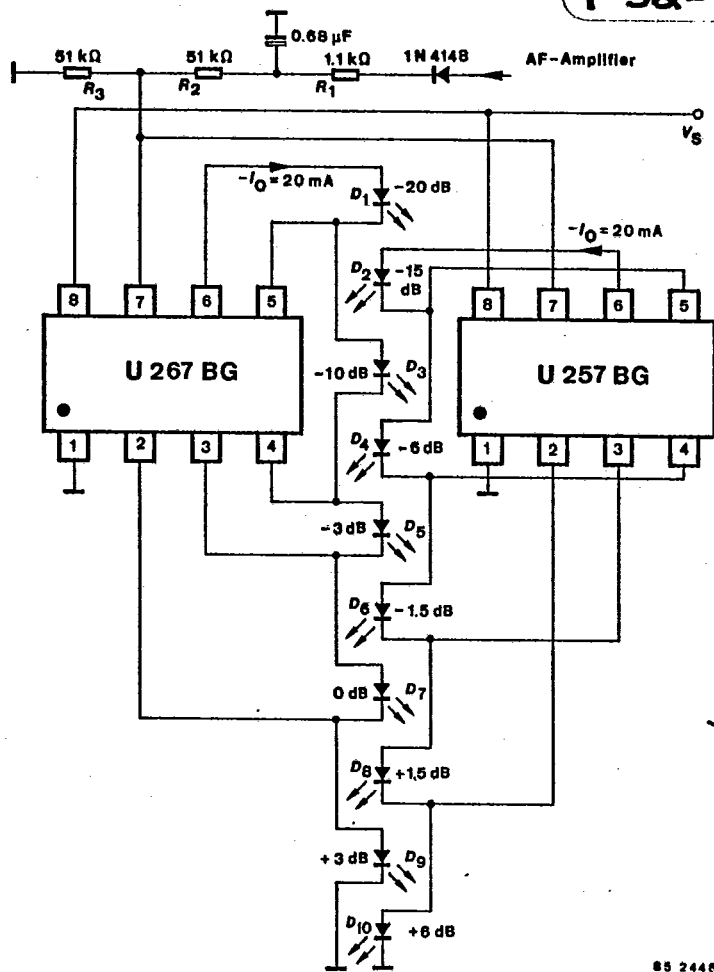

Fig. 5 Logarithmic AF recording level display with 5 LED's



85 2448 0

Fig. 6 Logarithmic AF recording level display with 10 LED's

U 237 BG · U 247 BG  
U 257 BG · U 267 BG

T-52-13-07

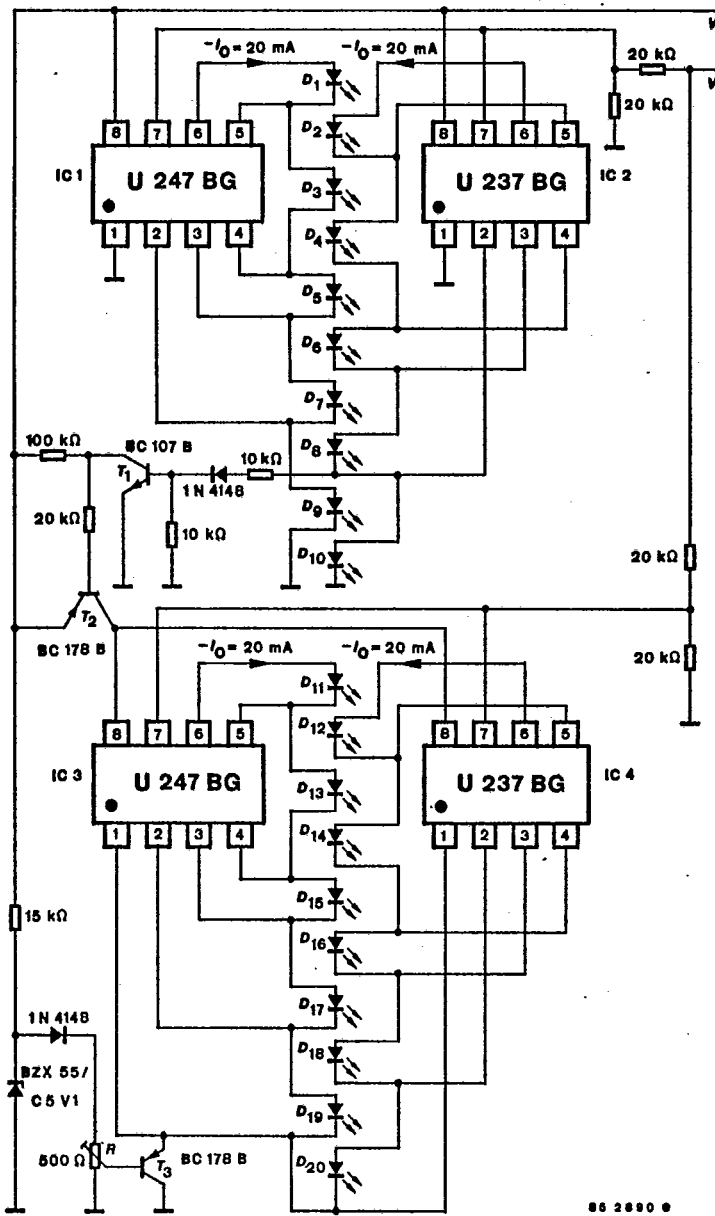
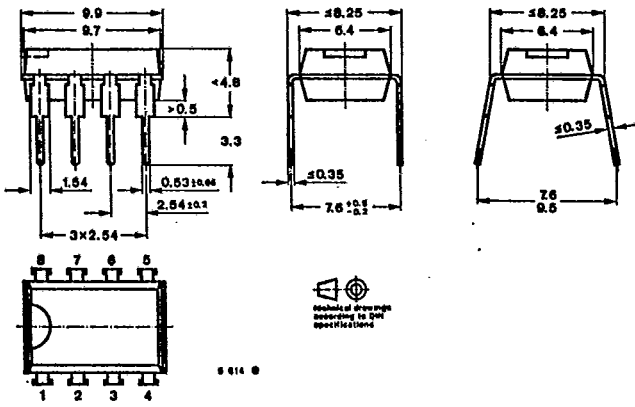

Fig.7 Driver for 20LED's

U 237 BG · U 247 BG  
U 257 BG · U 267 BG

T-52-13-07

Dimensions in mm



Plastic case  
DIP 8  
Weight max. 1 g