

Preliminary

GENERAL DESCRIPTION

EM73A89B is an advanced single chip CMOS 4-bit micro-controller. It contains 16K-byte ROM, 1012-nibble RAM, 4-bit ALU, 13-level subroutine nesting, 22-stage time base, two 12-bit timer/counters for the kernel function, and one high speed counter. EM73A89B also equipped with 6 interrupt sources, 3~7 I/O ports (including 1 input port and 2~7 bidirection ports), LCD display (64x16 or 64x32), built-in watch-dog-timer and speech synthesizer.

Its low power consumption and high speed feature are further strengthened with DUAL, SLOW, IDLE and STOP operation mode for optimized power saving.

FEATURES

- Operation voltage : 2.2V to 3.6V.
- Clock source : Dual clock system. Low-frequency oscillator is 32KHz. Crystal oscillator or RC oscillator by mask option and high-frequency oscillator is a built-in internal oscillator.
- Instruction set : 107 powerful instructions.
- Instruction cycle time : 0.85 μ s for 9.2M or 1.7 μ s for 4.6M Hz selected by mask option (high speed clock). 122 μ s for 32768 Hz (low speed clock, frequency double).
- ROM capacity : 16K x 8 bits.
- RAM capacity : 1012 x 4 bits.
- Input port : 1 port (P0.0-P0.3), IDLE/STOP releasing function is available by mask option. (each input pin has a pull-up and pull-down resistor available by mask option).
- Bidirection port : 2~7 ports (P1, P2, P4, P5, P6, P7, P8). IDLE/STOP release function for P8(0..3) is available by mask option. P1, P2, P5, P6, P7 are shared with LCD pins.
- Built-in watch-dog-timer counter : It is available by mask option.
- 12-bit timer/counter : Two 12-bit timer/counters are programmable for timer, event counter and pulse width measurement mode.
- Built-in time base counter : 22 stages.
- Subroutine nesting : Up to 13 levels.
- Interrupt : External interrupt 2 input interrupt sources.
Internal interrupt 2 timer overflow interrupts, 1 time base interrupt.
1 speech/HTC interrupt.
- High speed counter : The high speed counter includes one 8-bit high speed counter and a resistor to frequency oscillator. It has resistor to frequency oscillation mode, melody mode and auto load timer mode.
- LCD driver : 64x32 or 64x16 dots, 1/32 or 1/16 duty, 1/5 bias by mask option.
- Speech synthesizer : 992K speech data ROM (use as 992K nibbles data ROM).
- PWM or current D/A : Output selection by mask option.
- Power saving function : SLOW, IDLE, STOP operation modes.
- Package type : Chip form 126 pins.

FUNCTION BLOCK DIAGRAM

Preliminary

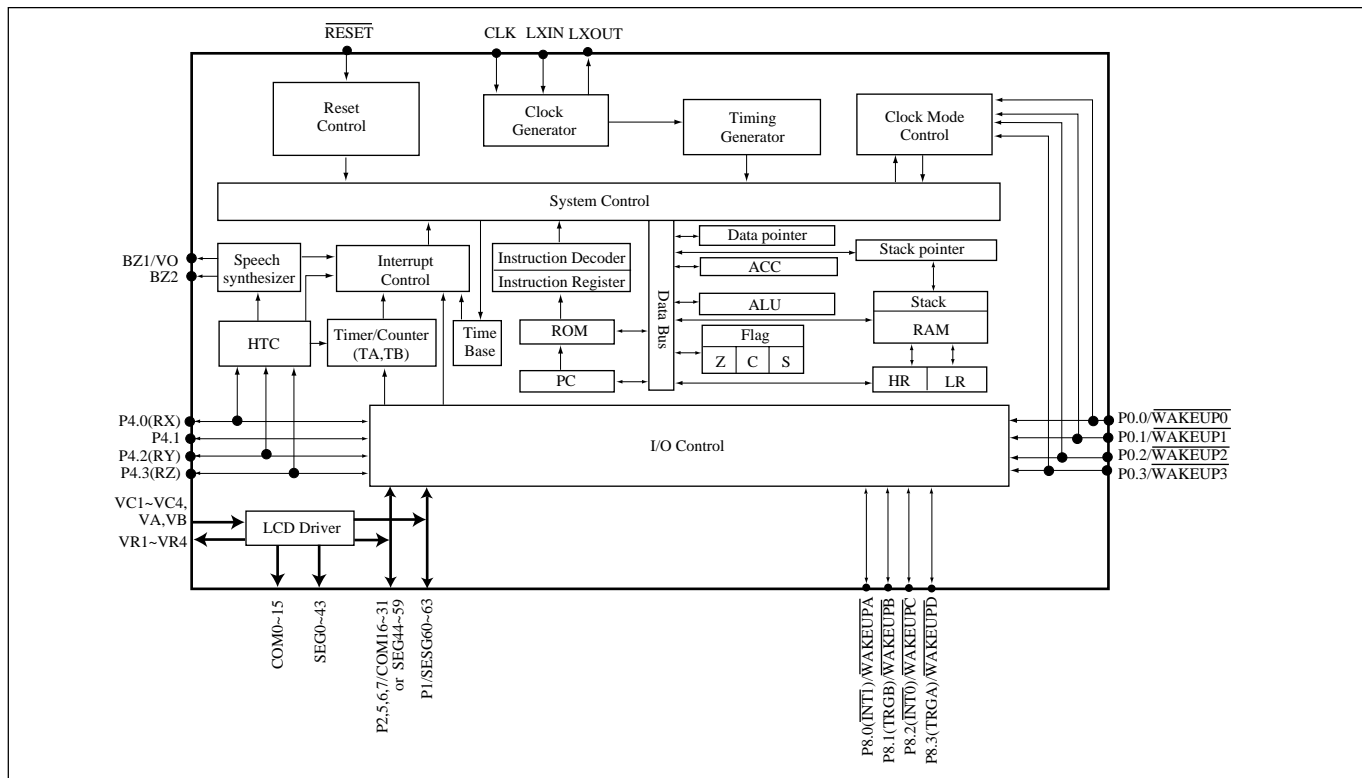

PIN DESCRIPTIONS

Symbol	Pin-type	Function
V_{DD}, V_{DD2}		Power supply (+)
V_{SS}		Power supply (-)
\overline{RESET}	RESET-A	System reset input signal, low active mask option : none pull-up
CLK	OSC-G	Capacitor connecting pin for internal high frequency oscillator.
LXIN	OSC-B/OSC-H	Crystal/Resistor connecting pin for low speed clock source.
LXOUT	OSC-B	Crystal connecting pin for low speed clock source.
P0(0..3)/WAKEUP0..3	INPUT-B	4-bit input port with IDLE/STOP releasing function mask option : wakeup enable, pull-up wakeup enable, none wakeup disable, pull-up wakeup disable, pull-down wakeup disable, none
P4.0(RX), P4.2(RY), P4.3(RZ)	I/O-X1	3-bit bidirection I/O pins or RF oscillation input pins. mask option : open-drain (apply to RF oscillation) high current push-pull normal current push-pull low current push-pull
P4.1	I/O-Q1	1-bit bidirection I/O pin. mask option : open-drain high current push-pull normal current push-pull low current push-pull

* This specification are subject to be changed without notice.

Preliminary

Symbol	Pin-type	Function
P8.0(INT1)/WAKEUPA P8.2(INT0)/WAKEUPC	I/O-X1	2-bit bidirection I/O port with external interrupt sources input and IDLE /STOP releasing function mask option : wakeup enable, normal current push-pull wakeup enable, low current push-pull wakeup disable, high current push-pull wakeup disable, normal current push-pull wakeup disable, low current push-pull wakeup disable, open drain
P8.1(TRGB)/WAKEUPB P8.3(TRGA)/WAKEUPD	I/O-X1	2-bit bidirection I/O port with time/counter A,B external input and IDLE /STOP releasing function mask option : wakeup enable, normal current push-pull wakeup enable, low current push-pull wakeup disable, high current push-pull wakeup disable, normal current push-pull wakeup disable, low current push-pull wakeup disable, open drain
VCA, VCB, V1~V6		LCD bias voltage pins
BZ1/VO		PWM or current D/A output pin for speech synthesizer by mask option
BZ2		PWM output pin for speech synthesizer
TEST		Tie Vss as package type, no connecting as COB type.

***16 COMMONS :**

COM0~COM15		LCD common output pins
SEG0~SEG59		LCD segment output pins
P1(0..3)/SEG63..60	I/O-P	4-bit bidirection I/O pins with LCD segment pins mask option : LCD segment pin push-pull open-drain
P2(0..3),P5(0..3), P6(0..3),P7(0..3)	I/O-P	16-bit bidirection I/O pins mask option : push-pull open-drain

***32 COMMONS :**

COM0~COM31		LCD common output pins
SEG0~SEG43		LCD segment output pins
P1(0..3)/SEG63..60, P2(0..3)/SEG59..56, P5(0..3)/SEG55..52, P6(0..3)/SEG51..48, P7(0..3)/SEG47..44	I/O-P	16-bit bidirection I/O pins with LCD segment pins mask option : LCD segment pin push-pull open-drain

Preliminary

FUNCTION DESCRIPTIONS

PROGRAM ROM (16K X 8 bits)

16 K x 8 bits program ROM contains user's program and some fixed data.

The basic structure of the program ROM may be categorized into 5 partitions.

1. Address 0000h : Reset start address.
2. Address 0002h - 000Ch : 6 kinds of interrupt service routine entry addresses.
3. Address 000Eh - 0086h : SCALL subroutine entry address, only available at 000Eh, 0016h, 001Eh, 0026h, 002Eh, 0036h, 003Eh, 0046h, 004Eh, 0056h, 005Eh, 0066h, 006Eh, 0076h, 007Eh, 0086h.
4. Address 0000h - 07FFh : LCALL subroutine entry address.
5. Address 0000h - 1FFFh : Except used as above function, the other region can be used as user's program and data region.

address Bank 0 :

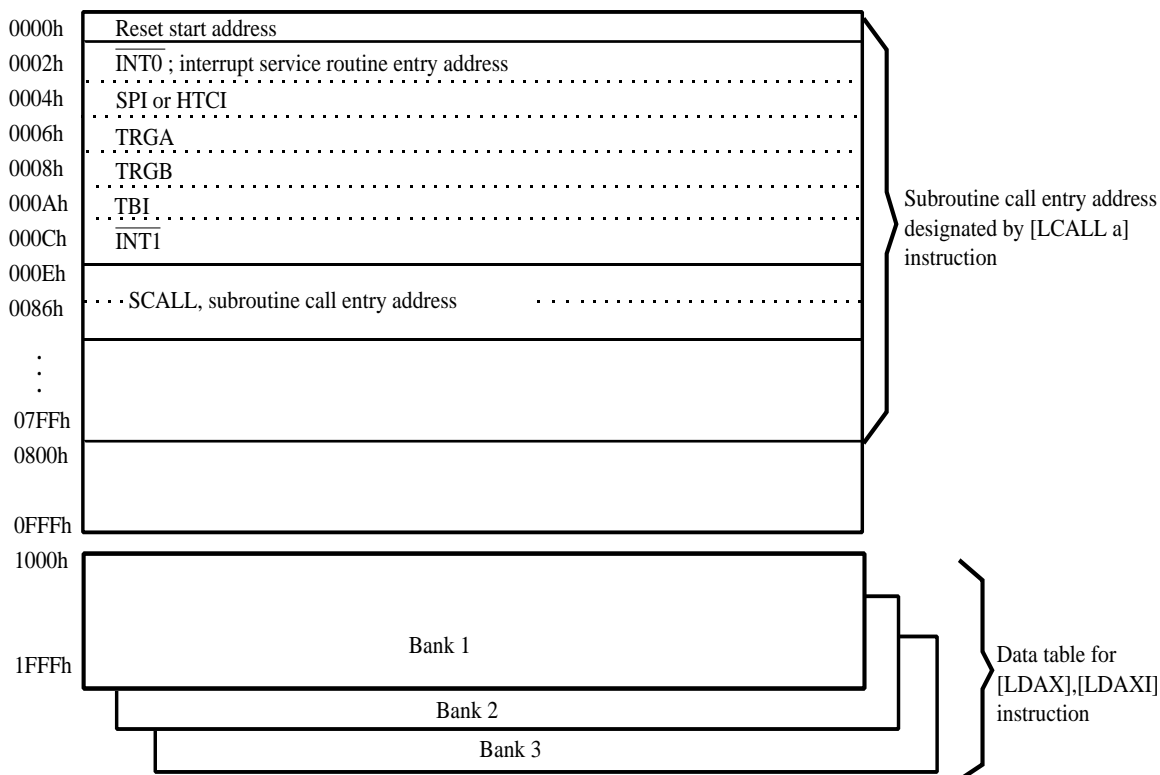

Preliminary

User's program and fixed data are stored in the program ROM. User's program is executed using the PC value to fetch an instruction code.

The 16Kx8 bits program ROM can be divided into 4 banks. There are 4Kx8 bits per bank.

The program ROM bank is selected by P3(1..0). The program counter is a 13-bit binary counter. The PC and P3 are initialized to "0" during reset.

When P3(1..0)=00B or 11B, the bank0 and bank1 of program ROM will be selected. P3(1..0)=01B, the bank0 and bank2 will be selected. P3(1..0)=10B, the bank0 and bank3 will be selected.

Address	P3=xx00B P3=xx11B	P3=xx01B	P3=xx10B
0000h	Bank0	Bank0	Bank0
:			
0FFFh			
1000h	Bank1	Bank2	Bank3
:			
1FFFh			

PROGRAM EXAMPLE:

```

      BANK 0
START:  :
        :
        :
        LDIA #00H           ; set program ROM to bank1
        OUTA P3
        B    XA1
      XA :
        :
        :
        LDIA #01H           ; set program ROM to bank2
        OUTA P3
        B    XB1
      XB :
        :
        :
        LDIA #02H           ; set program ROM to bank3
        OUTA P3
        B    XC1
      XC :
        :
        :
        B    XD
      XD :
        :
        :
        :
;-----
      BANK 1
      XA1:
        :
        :
        B    XA
      XA2:
        :
    
```

Preliminary

```

        B      XA2
        :
;-----
XB1 :      BANK 2
        :
        :
        B      XB
        :
XB2 :      :
        :
        B      XB2
        :
;-----
XC1 :      BANK 3
        :
        :
        B      XC
        :
XC2 :      :
        :
        B      XC2
    
```

Fixed data can be read out by table-look-up instruction. Table-look-up instruction is requires the Data point (DP) to indicate the ROM address in obtaining the ROM code data (Except bank 0) :

```

LDAX      Acc ← ROM[DP]L
LDAXI     Acc ← ROM[DP]H,DP+1
    
```

DP is a 12-bit data register that stores the program ROM address as pointer for the ROM code data. User has to initially load ROM address into DP with instructions "STADPL", and "STADPM, STADPH", then to obtain the lower nibble of ROM code data by instruction "LDAX" and higher nibble by instruction "LDAXI".

PROGRAM EXAMPLE: Read out the ROM code of address 1777h by table-look-up instruction.

```

LDIA      #07h;
STADPL           ; [DP]L ← 07h
STADPM          ; [DP]M ← 07h
STADPH          ; [DP]H ← 07h, Load DP=777h
:
LDL         #00h;
LDH         #03h;
LDAX                ; ACC ← 6h
STAMI                ; RAM[30] ← 6h
LDAXI                ; ACC ← 5h
STAM                ; RAM[31] ← 5h
:
ORG         1777h
DATA        56h;
    
```

DATA RAM (1012-nibble)

A total 1012 - nibble data RAM is available from address 000 to 3FFh
Data RAM includes the zero page region, stacks and data areas.



Preliminary

Bank 0	Address	0	1	2	3	4	5	6	7	8	9	A	B	C	D	E	F																																																																																																																																																																																																																																																																																																																																																																																																																																																																																																																																																																																																																																																																																																																																																																																																																																																																																																																																																																																																																			
P9=xx00B	000-00Fh	ZERO PAGE																																																																																																																																																																																																																																																																																																																																																																																																																																																																																																																																																																																																																																																																																																																																																																																																																																																																																																																																																																																																																																		
	010-01Fh																																																																																																																																																																																																																																																																																																																																																																																																																																																																																																																																																																																																																																																																																																																																																																																																																																																																																																																																																																																																																																			
	020-02Fh																																																																																																																																																																																																																																																																																																																																																																																																																																																																																																																																																																																																																																																																																																																																																																																																																																																																																																																																																																																																																																			
	030-03Fh																																																																																																																																																																																																																																																																																																																																																																																																																																																																																																																																																																																																																																																																																																																																																																																																																																																																																																																																																																																																																																			
	040-04Fh																																																																																																																																																																																																																																																																																																																																																																																																																																																																																																																																																																																																																																																																																																																																																																																																																																																																																																																																																																																																																																			
	050-05Fh																																																																																																																																																																																																																																																																																																																																																																																																																																																																																																																																																																																																																																																																																																																																																																																																																																																																																																																																																																																																																																			
	060-06Fh																																																																																																																																																																																																																																																																																																																																																																																																																																																																																																																																																																																																																																																																																																																																																																																																																																																																																																																																																																																																																																			
	070-07Fh																																																																																																																																																																																																																																																																																																																																																																																																																																																																																																																																																																																																																																																																																																																																																																																																																																																																																																																																																																																																																																			
	080-08Fh																																																																																																																																																																																																																																																																																																																																																																																																																																																																																																																																																																																																																																																																																																																																																																																																																																																																																																																																																																																																																																			
	090-09Fh																																																																																																																																																																																																																																																																																																																																																																																																																																																																																																																																																																																																																																																																																																																																																																																																																																																																																																																																																																																																																																			
	0A0-0AFh																																																																																																																																																																																																																																																																																																																																																																																																																																																																																																																																																																																																																																																																																																																																																																																																																																																																																																																																																																																																																																			
	0B0-0BFh																																																																																																																																																																																																																																																																																																																																																																																																																																																																																																																																																																																																																																																																																																																																																																																																																																																																																																																																																																																																																																			
	0C0-0CFh	Level 0				Level 1				Level 2				Level 3																																																																																																																																																																																																																																																																																																																																																																																																																																																																																																																																																																																																																																																																																																																																																																																																																																																																																																																																																																																																																						
	0D0-0DFh	Level 4				Level 5				Level 6				Level 7																																																																																																																																																																																																																																																																																																																																																																																																																																																																																																																																																																																																																																																																																																																																																																																																																																																																																																																																																																																																																						
	0E0-0EFh	Level 8				Level 8				Level 10				Level 11																																																																																																																																																																																																																																																																																																																																																																																																																																																																																																																																																																																																																																																																																																																																																																																																																																																																																																																																																																																																																						
	0F0-0FFh	Level 12																																																																																																																																																																																																																																																																																																																																																																																																																																																																																																																																																																																																																																																																																																																																																																																																																																																																																																																																																																																																																																		
Bank 1																																																																																																																																																																																																																																																																																																																																																																																																																																																																																																																																																																																																																																																																																																																																																																																																																																																																																																																																																																																																																																				
P9=xx01B	100-10Fh																																																																																																																																																																																																																																																																																																																																																																																																																																																																																																																																																																																																																																																																																																																																																																																																																																																																																																																																																																																																																																			
	110-11Fh																																																																																																																																																																																																																																																																																																																																																																																																																																																																																																																																																																																																																																																																																																																																																																																																																																																																																																																																																																																																																																			
	:																																																																																																																																																																																																																																																																																																																																																																																																																																																																																																																																																																																																																																																																																																																																																																																																																																																																																																																																																																																																																																			
	:																																																																																																																																																																																																																																																																																																																																																																																																																																																																																																																																																																																																																																																																																																																																																																																																																																																																																																																																																																																																																																			
	1E0-1EFh																																																																																																																																																																																																																																																																																																																																																																																																																																																																																																																																																																																																																																																																																																																																																																																																																																																																																																																																																																																																																																			
	1F0-1FFh																																																																																																																																																																																																																																																																																																																																																																																																																																																																																																																																																																																																																																																																																																																																																																																																																																																																																																																																																																																																																																			
Bank 2																																																																																																																																																																																																																																																																																																																																																																																																																																																																																																																																																																																																																																																																																																																																																																																																																																																																																																																																																																																																																																				
P9=xx10B	200-20Fh	COM0																																																																																																																																																																																																																																																																																																																																																																																																																																																																																																																																																																																																																																																																																																																																																																																																																																																																																																																																																																																																																																		
	210-21Fh	COM1																																																																																																																																																																																																																																																																																																																																																																																																																																																																																																																																																																																																																																																																																																																																																																																																																																																																																																																																																																																																																																		
	220-22Fh	COM2																																																																																																																																																																																																																																																																																																																																																																																																																																																																																																																																																																																																																																																																																																																																																																																																																																																																																																																																																																																																																																		
	230-23Fh	COM3																																																																																																																																																																																																																																																																																																																																																																																																																																																																																																																																																																																																																																																																																																																																																																																																																																																																																																																																																																																																																																		
	240-24Fh	COM4																																																																																																																																																																																																																																																																																																																																																																																																																																																																																																																																																																																																																																																																																																																																																																																																																																																																																																																																																																																																																																		
	250-25Fh	COM5																																																																																																																																																																																																																																																																																																																																																																																																																																																																																																																																																																																																																																																																																																																																																																																																																																																																																																																																																																																																																																		
	260-26Fh	COM6																																																																																																																																																																																																																																																																																																																																																																																																																																																																																																																																																																																																																																																																																																																																																																																																																																																																																																																																																																																																																																		
	270-27Fh	COM7																																																																																																																																																																																																																																																																																																																																																																																																																																																																																																																																																																																																																																																																																																																																																																																																																																																																																																																																																																																																																																		
	280-28Fh	COM8																																																																																																																																																																																																																																																																																																																																																																																																																																																																																																																																																																																																																																																																																																																																																																																																																																																																																																																																																																																																																																		
	290-29Fh	COM9																																																																																																																																																																																																																																																																																																																																																																																																																																																																																																																																																																																																																																																																																																																																																																																																																																																																																																																																																																																																																																		
	2A0-2AFh	COM10																																																																																																																																																																																																																																																																																																																																																																																																																																																																																																																																																																																																																																																																																																																																																																																																																																																																																																																																																																																																																																		
	2B0-2BFh	COM11																																																																																																																																																																																																																																																																																																																																																																																																																																																																																																																																																																																																																																																																																																																																																																																																																																																																																																																																																																																																																																		
	2C0-2CFh	COM12																																																																																																																																																																																																																																																																																																																																																																																																																																																																																																																																																																																																																																																																																																																																																																																																																																																																																																																																																																																																																																		
	2D0-2DFh	COM13																																																																																																																																																																																																																																																																																																																																																																																																																																																																																																																																																																																																																																																																																																																																																																																																																																																																																																																																																																																																																																		
	2E0-2EFh	COM14																																																																																																																																																																																																																																																																																																																																																																																																																																																																																																																																																																																																																																																																																																																																																																																																																																																																																																																																																																																																																																		
	2F0-2FFh	COM15																																																																																																																																																																																																																																																																																																																																																																																																																																																																																																																																																																																																																																																																																																																																																																																																																																																																																																																																																																																																																																		
Bank 3																																																																																																																																																																																																																																																																																																																																																																																																																																																																																																																																																																																																																																																																																																																																																																																																																																																																																																																																																																																																																																				
P9=xx11B	300-30Fh	COM16																																																																																																																																																																																																																																																																																																																																																																																																																																																																																																																																																																																																																																																																																																																																																																																																																																																																																																																																																																																																																																		
	310-31Fh	COM17																																																																																																																																																																																																																																																																																																																																																																																																																																																																																																																																																																																																																																																																																																																																																																																																																																																																																																																																																																																																																																		
	320-32Fh	COM18																																																																																																																																																																																																																																																																																																																																																																																																																																																																																																																																																																																																																																																																																																																																																																																																																																																																																																																																																																																																																																		
	330-33Fh	COM19																																																																																																																																																																																																																																																																																																																																																																																																																																																																																																																																																																																																																																																																																																																																																																																																																																																																																																																																																																																																																																		
	340-34Fh	COM20																																																																																																																																																																																																																																																																																																																																																																																																																																																																																																																																																																																																																																																																																																																																																																																																																																																																																																																																																																																																																																		
	350-35Fh	COM21																																																																																																																																																																																																																																																																																																																																																																																																																																																																																																																																																																																																																																																																																																																																																																																																																																																																																																																																																																																																																																		
	360-36Fh	COM22																																																																																																																																																																																																																																																																																																																																																																																																																																																																																																																																																																																																																																																																																																																																																																																																																																																																																																																																																																																																																																		
	370-37Fh	COM23																																																																																																																																																																																																																																																																																																																																																																																																																																																																																																																																																																																																																																																																																																																																																																																																																																																																																																																																																																																																																																		
	380-38Fh	COM24																																																																																																																																																																																																																																																																																																																																																																																																																																																																																																																																																																																																																																																																																																																																																																																																																																																																																																																																																																																																																																		
	390-39Fh	COM25																																																																																																																																																																																																																																																																																																																																																																																																																																																																																																																																																																																																																																																																																																																																																																																																																																																																																																																																																																																																																																		
	3A0-3AFh	COM26																																																																																																																																																																																																																																																																																																																																																																																																																																																																																																																																																																																																																																																																																																																																																																																																																																																																																																																																																																																																																																		
	3B0-3BFh	COM27																																																																																																																																																																																																																																																																																																																																																																																																																																																																																																																																																																																																																																																																																																																																																																																																																																																																																																																																																																																																																																		
	3C0-3CFh	COM28																																																																																																																																																																																																																																																																																																																																																																																																																																																																																																																																																																																																																																																																																																																																																																																																																																																																																																																																																																																																																																		
	3D0-3DFh	COM29																																																																																																																																																																																																																																																																																																																																																																																																																																																																																																																																																																																																																																																																																																																																																																																																																																																																																																																																																																																																																																		
	3E0-3EFh	COM30																																																																																																																																																																																																																																																																																																																																																																																																																																																																																																																																																																																																																																																																																																																																																																																																																																																																																																																																																																																																																																		
	3F0-3FFh	COM31																																																																																																																																																																																																																																																																																																																																																																																																																																																																																																																																																																																																																																																																																																																																																																																																																																																																																																																																																																																																																																		
		SEG01	SEG02	SEG03	SEG04	SEG05	SEG06	SEG07	SEG08	SEG09	SEG0A	SEG0B	SEG0C	SEG0D	SEG0E	SEG0F	SEG10	SEG11	SEG12	SEG13	SEG14	SEG15	SEG16	SEG17	SEG18	SEG19	SEG20	SEG21	SEG22	SEG23	SEG24	SEG25	SEG26	SEG27	SEG28	SEG29	SEG30	SEG31	SEG32	SEG33	SEG34	SEG35	SEG36	SEG37	SEG38	SEG39	SEG40	SEG41	SEG42	SEG43	SEG44	SEG45	SEG46	SEG47	SEG48	SEG49	SEG50	SEG51	SEG52	SEG53	SEG54	SEG55	SEG56	SEG57	SEG58	SEG59	SEG60	SEG61	SEG62	SEG63	SEG64	SEG65	SEG66	SEG67	SEG68	SEG69	SEG70	SEG71	SEG72	SEG73	SEG74	SEG75	SEG76	SEG77	SEG78	SEG79	SEG80	SEG81	SEG82	SEG83	SEG84	SEG85	SEG86	SEG87	SEG88	SEG89	SEG90	SEG91	SEG92	SEG93	SEG94	SEG95	SEG96	SEG97	SEG98	SEG99	SEG100	SEG101	SEG102	SEG103	SEG104	SEG105	SEG106	SEG107	SEG108	SEG109	SEG110	SEG111	SEG112	SEG113	SEG114	SEG115	SEG116	SEG117	SEG118	SEG119	SEG120	SEG121	SEG122	SEG123	SEG124	SEG125	SEG126	SEG127	SEG128	SEG129	SEG130	SEG131	SEG132	SEG133	SEG134	SEG135	SEG136	SEG137	SEG138	SEG139	SEG140	SEG141	SEG142	SEG143	SEG144	SEG145	SEG146	SEG147	SEG148	SEG149	SEG150	SEG151	SEG152	SEG153	SEG154	SEG155	SEG156	SEG157	SEG158	SEG159	SEG160	SEG161	SEG162	SEG163	SEG164	SEG165	SEG166	SEG167	SEG168	SEG169	SEG170	SEG171	SEG172	SEG173	SEG174	SEG175	SEG176	SEG177	SEG178	SEG179	SEG180	SEG181	SEG182	SEG183	SEG184	SEG185	SEG186	SEG187	SEG188	SEG189	SEG190	SEG191	SEG192	SEG193	SEG194	SEG195	SEG196	SEG197	SEG198	SEG199	SEG200	SEG201	SEG202	SEG203	SEG204	SEG205	SEG206	SEG207	SEG208	SEG209	SEG210	SEG211	SEG212	SEG213	SEG214	SEG215	SEG216	SEG217	SEG218	SEG219	SEG220	SEG221	SEG222	SEG223	SEG224	SEG225	SEG226	SEG227	SEG228	SEG229	SEG230	SEG231	SEG232	SEG233	SEG234	SEG235	SEG236	SEG237	SEG238	SEG239	SEG240	SEG241	SEG242	SEG243	SEG244	SEG245	SEG246	SEG247	SEG248	SEG249	SEG250	SEG251	SEG252	SEG253	SEG254	SEG255	SEG256	SEG257	SEG258	SEG259	SEG260	SEG261	SEG262	SEG263	SEG264	SEG265	SEG266	SEG267	SEG268	SEG269	SEG270	SEG271	SEG272	SEG273	SEG274	SEG275	SEG276	SEG277	SEG278	SEG279	SEG280	SEG281	SEG282	SEG283	SEG284	SEG285	SEG286	SEG287	SEG288	SEG289	SEG290	SEG291	SEG292	SEG293	SEG294	SEG295	SEG296	SEG297	SEG298	SEG299	SEG300	SEG301	SEG302	SEG303	SEG304	SEG305	SEG306	SEG307	SEG308	SEG309	SEG310	SEG311	SEG312	SEG313	SEG314	SEG315	SEG316	SEG317	SEG318	SEG319	SEG320	SEG321	SEG322	SEG323	SEG324	SEG325	SEG326	SEG327	SEG328	SEG329	SEG330	SEG331	SEG332	SEG333	SEG334	SEG335	SEG336	SEG337	SEG338	SEG339	SEG340	SEG341	SEG342	SEG343	SEG344	SEG345	SEG346	SEG347	SEG348	SEG349	SEG350	SEG351	SEG352	SEG353	SEG354	SEG355	SEG356	SEG357	SEG358	SEG359	SEG360	SEG361	SEG362	SEG363	SEG364	SEG365	SEG366	SEG367	SEG368	SEG369	SEG370	SEG371	SEG372	SEG373	SEG374	SEG375	SEG376	SEG377	SEG378	SEG379	SEG380	SEG381	SEG382	SEG383	SEG384	SEG385	SEG386	SEG387	SEG388	SEG389	SEG390	SEG391	SEG392	SEG393	SEG394	SEG395	SEG396	SEG397	SEG398	SEG399	SEG400	SEG401	SEG402	SEG403	SEG404	SEG405	SEG406	SEG407	SEG408	SEG409	SEG410	SEG411	SEG412	SEG413	SEG414	SEG415	SEG416	SEG417	SEG418	SEG419	SEG420	SEG421	SEG422	SEG423	SEG424	SEG425	SEG426	SEG427	SEG428	SEG429	SEG430	SEG431	SEG432	SEG433	SEG434	SEG435	SEG436	SEG437	SEG438	SEG439	SEG440	SEG441	SEG442	SEG443	SEG444	SEG445	SEG446	SEG447	SEG448	SEG449	SEG450	SEG451	SEG452	SEG453	SEG454	SEG455	SEG456	SEG457	SEG458	SEG459	SEG460	SEG461	SEG462	SEG463	SEG464	SEG465	SEG466	SEG467	SEG468	SEG469	SEG470	SEG471	SEG472	SEG473	SEG474	SEG475	SEG476	SEG477	SEG478	SEG479	SEG480	SEG481	SEG482	SEG483	SEG484	SEG485	SEG486	SEG487	SEG488	SEG489	SEG490	SEG491	SEG492	SEG493	SEG494	SEG495	SEG496	SEG497	SEG498	SEG499	SEG500	SEG501	SEG502	SEG503	SEG504	SEG505	SEG506	SEG507	SEG508	SEG509	SEG510	SEG511	SEG512	SEG513	SEG514	SEG515	SEG516	SEG517	SEG518	SEG519	SEG520	SEG521	SEG522	SEG523	SEG524	SEG525	SEG526	SEG527	SEG528	SEG529	SEG530	SEG531	SEG532	SEG533	SEG534	SEG535	SEG536	SEG537	SEG538	SEG539	SEG540	SEG541	SEG542	SEG543	SEG544	SEG545	SEG546	SEG547	SEG548	SEG549	SEG550	SEG551	SEG552	SEG553	SEG554	SEG555	SEG556	SEG557	SEG558	SEG559	SEG560	SEG561	SEG562	SEG563	SEG564	SEG565	SEG566	SEG567	SEG568	SEG569	SEG570	SEG571	SEG572	SEG573	SEG574	SEG575	SEG576	SEG577	SEG578	SEG579	SEG580	SEG581	SEG582	SEG583	SEG584	SEG585	SEG586	SEG587	SEG588	SEG589	SEG590	SEG591	SEG592	SEG593	SEG594	SEG595	SEG596	SEG597	SEG598	SEG599	SEG600	SEG601	SEG602	SEG603	SEG604	SEG605	SEG606	SEG607	SEG608	SEG609	SEG610	SEG611	SEG612	SEG613	SEG614	SEG615	SEG616	SEG617	SEG618	SEG619	SEG620	SEG621	SEG622	SEG623	SEG624	SEG625	SEG626	SEG627	SEG628	SEG629	SEG630	SEG631	SEG632	SEG633	SEG634	SEG635	SEG636	SEG637	SEG638	SEG639	SEG640	SEG641	SEG642	SEG643	SEG644	SEG645	SEG646	SEG647	SEG648	SEG649	SEG650	SEG651	SEG652	SEG653	SEG654	SEG655	SEG656	SEG657	SEG658	SEG659	SEG660	SEG661	SEG662	SEG663	SEG664	SEG665	SEG666	SEG667	SEG668	SEG669	SEG670	SEG671	SEG672	SEG673	SEG674	SEG675	SEG676	SEG677	SEG678	SEG679	SEG680	SEG681	SEG682	SEG683	SEG684	SEG685	SEG686	SEG687	SEG688	SEG689	SEG690	SEG691	SEG692	SEG693	SEG694	SEG695	SEG696	SEG697	SEG698	SEG699	SEG700	SEG701	SEG702	SEG703	SEG704	SEG705	SEG706	SEG707	SEG708	SEG709	SEG710	SEG711	SEG712	SEG713	SEG714	SEG715	SEG716	SEG717	SEG718	SEG719	SEG720	SEG721	SEG722	SEG723	SEG724	SEG725	SEG726	SEG727	SEG728	SEG729	SEG730	SEG731	SEG732	SEG733	SEG734	SEG735	SEG736	SEG737	SEG738	SEG739	SEG740	SEG741	SEG742	SEG743	SEG744	SEG745	SEG746	SEG747	SEG748	SEG749	SEG750	SEG751	SEG752	SEG753	SEG754	SEG755	SEG756	SEG757	SEG758	SEG759	SEG760	SEG761	SEG762	SEG763	SEG764	SEG765	SEG766	SEG767	SEG768	SEG769	SEG770	SEG771	SEG772	SEG773	SEG774	SEG775	SEG776	SEG777	SEG778	SEG779	SEG780	SEG781	SEG782	SEG783	SEG784	SEG785	SEG786	SEG787	SEG788	SEG789	SEG790	SEG791	SEG792	SEG793	SEG794	SEG795	SEG796	SEG797	SEG798	SEG799	SEG800	SEG801	SEG802	SEG803	SEG804	SEG805	SEG806	SEG807	SEG808	SEG809	SEG810	SEG811	SEG812	SEG813	SEG814	SEG815	SEG816	SEG817	SEG818	SEG819	SEG820	SEG821	SEG822	SEG823	SEG824	SEG825	SEG826	SEG827	SEG828	SEG829	SEG830	SEG831	SEG832	SEG833	SEG834	SEG835	SEG836	SEG837	SEG838	SEG839	SEG840	SEG841	SEG842	SEG843	SEG844	SEG845	SEG846	SEG847	SEG848	SEG849	SEG850	SEG851	SEG852	SEG853	SEG854	SEG855	SEG856	SEG857	SEG858	SEG859	SEG860	SEG861	SEG862	SEG863	SEG864	SEG865	SEG866	SEG867	SEG868	SEG869	SEG870	SEG871	SEG872	SEG873	SEG874	SEG875	SEG876	SEG877	SEG878	SEG879	SEG880	SEG881	SEG882	SEG883	SEG884	SEG885	SEG886	SEG887	SEG888	SEG889	SEG890	SEG891	SEG892	SEG893	SEG894	SEG895	SEG896	SEG897	SEG898	SEG899	SEG900	SEG901	SEG902	SEG903	SEG904	SEG905	SEG906	SEG907	SEG908	SEG909	SEG910	SEG911	SEG912	SEG913	SEG914	SEG915	SEG916	SEG917	SEG918	SEG919	SEG920	SEG921	SEG922	SEG923	SEG924	SEG925	SEG926	SEG927	SEG928	SEG929	SEG930	SEG931	SEG932	SEG933	SEG934	SEG935	SEG936	SEG937	SEG938	SEG939	SEG940	SEG941	SEG942	SEG943	SEG944	SEG945	SEG946	SEG947	SEG948	SEG949	SEG950	SEG951	SEG952	SEG953	SEG954	SEG955	SEG956	SEG957	SEG958	SEG959	SEG960	SEG961	SEG962	SEG963	SEG964	SEG965	SEG966	SEG967	SEG968	SEG969	SEG970	SEG971	SEG972	SEG973	SEG974	SEG975	SEG976	SEG977	SEG978	SEG979	SEG980	SEG981	SEG982	SEG983	SEG984	SEG985	SEG986	SEG987	SEG988	SEG

Preliminary

ZERO- PAGE:

From 000h to 00Fh is the zero-page location. It is used as the zero-page address mode pointer for the instruction of "STD #k,y; ADD #k,y; CLR y,b; CMP k,y".

PROGRAM EXAMPLE: To write immediate data "07h" to RAM [03] and to clear bit 2 of RAM [0Eh].

```
STD #07h, 03h ; RAM[03] ← 07h
CLR 0Eh,2 ; RAM[0Eh]2 ← 0
```

STACK:

There are 13 - level (maximum) stack levels that user can use for subroutine (including interrupt and CALL). User can assign any level be the starting stack by providing the level number to stack pointer (SP).

When an instruction (CALL or interrupt) is invoked, before enter the subroutine, the previous PC address is saved into the stack until returned from those subroutines, the PC value is restored by the data saved in stack.

DATA AREA:

Except the area used by user's application, the whole RAM can be used as data area for storing and loading general data.

ADDRESSING MODE

The 1012 nibble data memory consists of four banks (bank 0 ~ bank 3). There are 244x4 bits (address 000h~0F3h) in bank 0 and 768x4 bits (address 100h ~ 3FFh) in bank 1 ~ bank 3.

The bank is selected by P9.

P9 Initial value : * * 0 0

*	*	RBK
RBK	RAM bank	
0 0	Bank0	
0 1	Bank1	
1 0	Bank2	
1 1	Bank3	

The Data Memory consists of three Address mode, namely -

(1) Indirect addressing mode:

The address in the bank is specified by the HL registers.

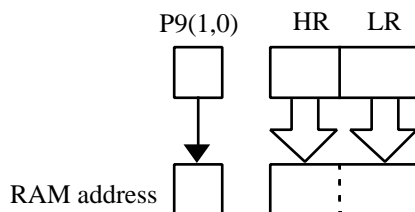

Preliminary

PROGRAM EXAMPLE: Load the data of RAM address "143h" to RAM address "032h".

```

OUT   #0001B,P9      ; RAM bank1
LDL   #3h            ; LR← 3
LDH   #4h            ; HR← 4
LDAM                      ; Acc← RAM[134h]
OUT   #0000B,P9      ; RAM bank0
LDL   #2h            ; LR← 2
LDH   #3h            ; HR← 3
STAM                      ; RAM[023h]← Acc
    
```

(2) Direct addressing mode:

The address in the bank is directly specified by 8 bits code of the second byte in the instruction field.

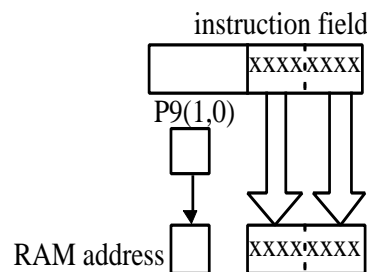

PROGRAM EXAMPLE: Load the data of RAM address "143h" to RAM address "023h".

```

OUT   #0001B,P9
LDA   43h            ; Acc← RAM[143h]
OUT   #0000B,P9
STA   23h            ; RAM[023h]← Acc
    
```

(3) Zero-page addressing mode:

The zero-page is in the bank 0 (address 000h~00Fh). The address is the lower 4 bits code of the second byte in the instruction field.

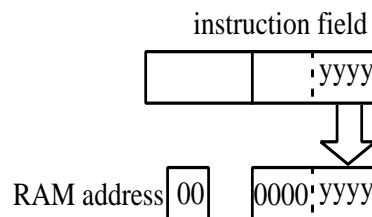

PROGRAM EXAMPLE: Write immediate "0Fh" to RAM address "005h".

```

STD   #0Fh,05h      ; RAM[05h]← 0Fh
    
```

PROGRAM COUNTER (16K ROM) *Preliminary*

Program counter (PC) is composed by a 13-bit counter, which indicates the next executed address for the instruction of program ROM instruction.

For BRANCH and CALL instructions, PC is changed by instruction indicating. PC only can indicate the address from 0000h-1FFFh. The bank number is decided by P3.

(1) Branch instruction:

SBR a

Object code: 00aa aaaa

Condition: SF=1; PC ← PC_{12-6,a} (branch condition satisfied)

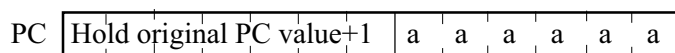

SF=0; PC ← PC + 1 (branch condition not satisfied)

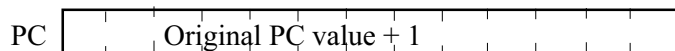

LBR a

Object code: 1100 aaaa aaaa aaaa

Condition: SF=1; PC ← PC_{12,a} (branch condition satisfied)

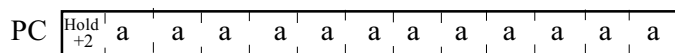

SF=0; PC ← PC + 2 (branch condition not satisfied)

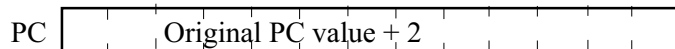

SLBR a

Object code: 0101 0101 1100 aaaa aaaa aaaa (a:1000h~1FFFh)

0101 0111 1100 aaaa aaaa aaaa (a:0000h~0FFFh)

Condition: SF=1; PC ← a (branch condition satisfied)

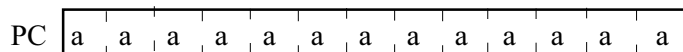

SF=0 ; PC ← PC + 3 (branch condition not satisfied)

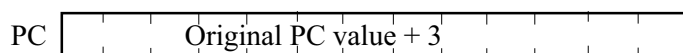

(2) Subroutine instruction:

SCALL a

Object code: 1110 nnnn

Condition : PC ← a ; a=8n+6 ; n=1..Fh ; a=86h, n=0

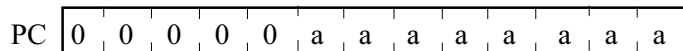

LCALL a

Object code: 0100 0aaa aaaa aaaa

Condition: PC ← a

Preliminary

PC

0	0	a	a	a	a	a	a	a	a	a	a	a	a
---	---	---	---	---	---	---	---	---	---	---	---	---	---

RET

Object code: 0100 1111

Condition: PC ← STACK[SP]; SP + 1

PC

The return address stored in stack													
------------------------------------	--	--	--	--	--	--	--	--	--	--	--	--	--

RTI

Object code: 0100 1101

Condition : FLAG. PC ← STACK[SP]; EI ← 1; SP + 1

PC

The return address stored in stack													
------------------------------------	--	--	--	--	--	--	--	--	--	--	--	--	--

(3) Interrupt acceptance operation:

When an interrupt is accepted, the original PC is pushed into stack and interrupt vector will be loaded into PC. The interrupt vectors are as follows :

$\overline{INT0}$ (External interrupt from P8.2)

PC

0	0	0	0	0	0	0	0	0	0	0	0	1	0
---	---	---	---	---	---	---	---	---	---	---	---	---	---

SPI (speech end interrupt)

PC

0	0	0	0	0	0	0	0	0	0	0	1	0	0
---	---	---	---	---	---	---	---	---	---	---	---	---	---

TRGA (Timer A overflow interrupt)

PC

0	0	0	0	0	0	0	0	0	0	1	1	0
---	---	---	---	---	---	---	---	---	---	---	---	---

TRGB (Time B overflow interrupt)

PC

0	0	0	0	0	0	0	0	0	1	0	0	0
---	---	---	---	---	---	---	---	---	---	---	---	---

TBI (Time base interrupt)

PC

0	0	0	0	0	0	0	0	0	1	0	1	0
---	---	---	---	---	---	---	---	---	---	---	---	---

$\overline{INT1}$ (External interrupt from P8.0)

PC

0	0	0	0	0	0	0	0	0	1	1	0	0
---	---	---	---	---	---	---	---	---	---	---	---	---

(4) Reset operation:

PC

0	0	0	0	0	0	0	0	0	0	0	0	0	0
---	---	---	---	---	---	---	---	---	---	---	---	---	---

Preliminary

(5) Other operations:

For 1-byte instruction execution: PC + 1

For 2-byte instruction execution: PC + 2

For 3-byte instruction execution: PC + 3

ACCUMULATOR

Accumulator(ACC) is a 4-bit data register for temporary data storage. For the arithmetic, logic and comparative operation..., ACC plays a role which holds the source data and result.

FLAGS

There are three kinds of flag, CF (Carry flag), ZF (Zero flag) and SF (Status flag), these three 1-bit flags are included by the arithmetic, logic and comparative operation.

All flags will be put into stack when an interrupt subroutine is served, and the flags will be restored after RTI instruction is executed.

(1) Carry Flag (CF)

The carry flag is affected by the following operations:

- a. Addition : CF as a carry out indicator, under addition operation, when a carry-out occurs, the CF is "1", likewise, if the operation has no carry-out, CF is "0".
- b. Subtraction : CF as a borrow-in indicator, under subtraction operation, when a borrow occurs, the CF is "0", likewise, if there is no borrow-in, the CF is "1".
- c. Comparison : CF as a borrow-in indicator for Comparison operation as in the subtraction operation.
- d. Rotation : CF shifts into the empty bit of accumulator for the rotation and holds the shift out data after rotation.
- e. CF test instruction : Under TFCFC instruction, the CF content is sent into SF then clear itself as "0". Under TTSFC instruction, the CF content is sent into SF then set itself as "1".

(2) Zero Flag (ZF)

ZF is affected by the result of ALU, if the ALU operation generates a "0" result, the ZF is "1", likewise, the ZF is "0".

(3) Status Flag (SF)

The SF is affected by instruction operation and system status.

- a. SF is initiated to "1" for reset condition.
- b. Branch instruction is decided by SF, when SF=1, branch condition is satisfied, likewise, when SF = 0, branch condition is unsatisfied.

Preliminary

PROGRAM EXAMPLE:

Check following arithmetic operation for CF, ZF, SF

	CF	ZF	SF
LDIA #00h;	-	1	1
LDIA #03h;	-	0	1
ADDA #05h;	-	0	1
ADDA #0Dh;	-	0	0
ADDA #0Eh;	-	0	0

ALU

The arithmetic operation of 4-bit data is performed in ALU unit. There are 2 flags that can be affected by the result of ALU operation, ZF and SF. The operation of ALU is affected by CF only.

ALU STRUCTURE

ALU supported user arithmetic operation functions, including Addition, Subtraction and Rotation.

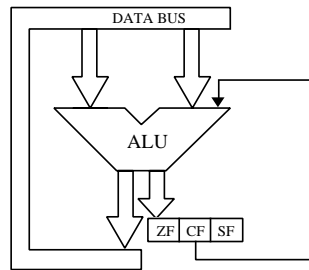

ALU FUNCTION

(1) Addition:

ALU supports addition function with instructions ADDAM, ADCAM, ADDM #k, ADD #k,y The addition operation affects CF and ZF. Under addition operation, if the result is "0", ZF will be "1", otherwise, ZF will be "0". When the addition operation has a carry-out, CF will be "1", otherwise, CF will be "0".

EXAMPLE:

Operation	Carry	Zero
3+4=7	0	0
7+F=6	1	0
0+0=0	0	1
8+8=0	1	1

(2) Subtraction:

ALU supports subtraction function with instructions SUBM #k, SUBA #k, SBCAM, DECM... . The subtraction operation affects CF and ZF. Under subtraction operation, if the result is negative, CF will be "0", and a borrow out, otherwise, if the result is positive, CF will be "1". For ZF, if the result of subtraction operation is "0", the ZF is "1", likewise, ZF is "1".

Preliminary

EXAMPLE:

Operation	Carry	Zero
8-4=4	1	0
7-F= -8(1000)	0	0
9-9=0	1	1

(3) Rotation:

Two types of rotation operation are available, one is rotation left, the other is rotation right. RLCA instruction rotates Acc value counter-clockwise, shift the CF value into the LSB bit of Acc and hold the shift out data in CF.

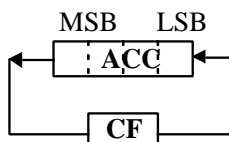

RRCA instruction operation rotates Acc value clockwise, shift the CF value into the MSB bit of Acc and hold the shift out data in CF.

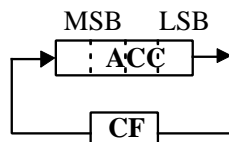

PROGRAM EXAMPLE: To rotate Acc clockwise (right) and shift a "1" into the MSB bit of Acc.
TTCFS; CF ← 1
RRCA; rotate Acc right and shift CF=1 into MSB.

HL REGISTER

HL register are two 4-bit registers, they are used as a pair of pointer for the RAM memory address. They are used as also 2 independent temporary 4-bit data registers. For certain instructions, L register can be a pointer to indicate the pin number (Port4 only).

HL REGISTER STRUCTURE

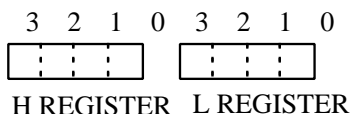

HL REGISTER FUNCTION

(1) HL register is used as a temporary register for instructions : LDL #k, LDH #k, THA, THL, INCL, DECL, EXAL, EXAH.

PROGRAM EXAMPLE: Load immediate data "5h" into L register, "0Dh" into H register.
LDL #05h;
LDH #0Dh;

(2) HL register is used as a pointer for the address of RAM memory for instructions : LDAM, STAM, STAMI ..

PROGRAM EXAMPLE: Store immediate data "#0Ah" into RAM of address 35h.

Preliminary

```
LDL #5h;
LDH #3h;
STDMI #0Ah; RAM[35] ← Ah
```

- (3) L register is used as a pointer to indicate the bit of I/O port for instructions : SELP, CLPL, TFPL,
(When LR = 0 indicate P4.0)

PROGRAM EXAMPLE: To set bit 0 of Port4 to "1"

```
LDL #00h;
SEPL ; P4.0 ← 1
```

STACK POINTER (SP)

Stack pointer is a 4-bit register that stores the present stack level number.

Before using stack, user must set the SP value first, CPU will not initiate the SP value after reset condition.

When a new subroutine is received, the SP is decreased by one automatically, likewise, if returning from a subroutine, the SP is increased by one.

The data transfer between ACC and SP is done with instructions "LDASP" and "STASP".

DATA POINTER (DP)

Data pointer is a 12-bit register that stores the ROM address can indicating the ROM code data specified by user (refer to data ROM).

CLOCK AND TIMING GENERATOR

The clock generator is supported by a dual clock system. The high-frequency oscillator is internal oscillator. The low-frequency oscillator may be sourced from crystal, the working frequency is 32 KHz.

CLOCK GENERATOR STRUCTURE

There are two clock generator for system clock control unit, P14 is the status register that hold the CPU status. P16, P19 and P22 are the command register for system clock mode control.

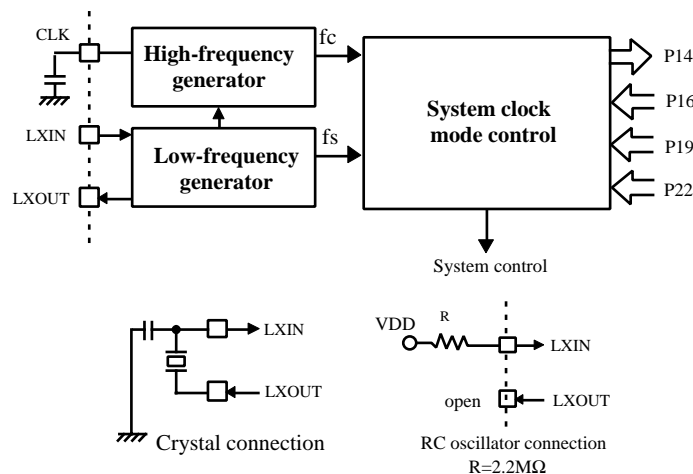

Preliminary

SYSTEM CLOCK MODE CONTROL

The system clock mode controller can start or stop the high-frequency and low-frequency clock oscillator and switch between the basic clocks. EM73A89B has four operation modes (DUAL, SLOW, IDLE and STOP operation modes).

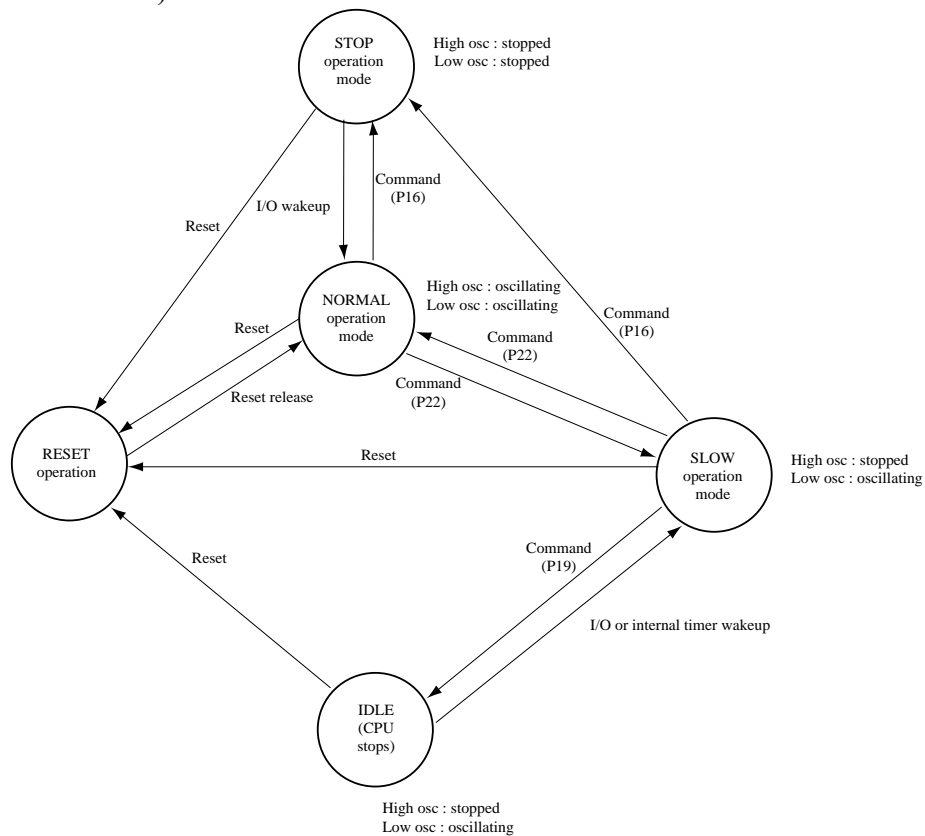

Operation Mode	Oscillator	System Clock	Available function	One instruction cycle
NORMAL	High, Low frequency	High frequency clock	LCD, speech, HTC.	8 / fc
SLOW	Low frequency	Low frequency clock	LCD, HTC	4 / fs
IDLE	Low frequency	CPU stops	LCD	-
STOP	None	CPU stops	All disable	-

DUAL OPERATION MODE

The 4-bit μ c is in the DUAL operation mode when the CPU is reseted. This mode is dual clock system (high-frequency and low-frequency clocks oscillating). It can be changed to SLOW or STOP operation mode with the command register (P22 or P16).

LCD display, speech synthesizer and sound generator are available for the DUAL operation mode.

SLOW OPERATION MODE

The SLOW operation mode is single clock system (low-frequency clock oscillating). It can be changed to the DUAL operation mode with the command register (P22), STOP operation mode with P16 and IDLE operation mode with P19.

LCD display is available for the SLOW operation mode. Speech synthesizer and sound generator are disabled in this mode.

Preliminary

P22 3 2 1 0 Initial value : ***0

*	*	*	SOM
---	---	---	-----

SOM	Select operation mode
0	DUAL operation mode
1	SLOW operation mode

P14 3 2 1 0 Initial value : 0000

ACT	WKS	SINT	CPUS
-----	-----	------	------

CPUS	CPU status	WKS	Wakeup status
0	DUAL operation mode	0	Wakeup not by internal timer
1	SLOW operation mode	1	Wakeup by internal timer

Port14 is the status register for CPU. P14.0 (CPU status) is a read-only bit. P14.2 (wakeup status) will be set as "1" when CPU is waked by internal timer. P14.2 will be cleared as "0" when user out data to P14. P14.1 is the interrupt source selector (refer to interrupt). P14.3 is the speech acknowledge signal (refer to speech synthesizer control).

IDLE OPERATION MODE

The IDLE operation mode suspends all CPU functions except the low-frequency clock oscillation and the LCD driver. It keeps the internal status with low power consumption without stopping the slow clock oscillator and LCD display.

LCD display is available for the IDLE operation mode. The high speed counter and speech synthesizer are disabled in this mode. The IDLE operation mode will be wakeup and return to the SLOW operation mode by the internal timing generator or I/O pins (P0(0..3)/WAKEUP 0..3 and P8(0..3)/WAKEUPA..D).

P19 3 2 1 0 Initial value : 0000

IDME	SIDR
------	------

IDME	Enable IDLE mode	SIDR	Select IDLE releasing condition
0 1	Enable IDLE mode	0 0	P0(0..3), P8(0..3) pin input
* *	no function	0 1	P0(0..3), P8(0..3) pin input and 1 sec signal
		1 0	P0(0..3), P8(0..3) pin input and 0.5 sec signal
		1 1	P0(0..3), P8(0..3) pin input and 15.625 ms signal

STOP OPERATION MODE

The STOP operation mode suspends system operation and holds the internal status immediately before the suspension with low power consumption. This mode will be released by reset or I/O pins (P0(0..3)/WAKEUP 0..3 or P8(0..3)/WAKEUP A..D).

LCD display, high speed counter and speech synthesizer are disabled in this mode.

Preliminary

P16 3 2 1 0 Initial value : *000

*	SWWT
---	------

SWWT	Enable STOP mode
1 0 1	Enable STOP mode
* * *	no function

GENERAL PURPOSE REGISTER (P10)

P10 is a 4-bit general purpose register which can be read, written and rested by all I/O instructions. (including : INA, INM, OUT, OUTA, OUTM, SEP, CLP, TTP, TFP)

PROGRAM EXAMPLE:

```

CHIP ROM16K
;-----RAM define area-----
DSEG
ORG 10H
HLBUF: RES 2 ; HL buffer for interrupt
P9BUF: RES 1 ; P9 (RAM bank) buffer for interrupt
:
;-----Interrupt subroutine-----
CSEG
ORG 004H
LBR SPI
:
SPI: OUTA P10 ; save Acc to general purpose register P10
INA P9
OUT #0000B,P9
STA P9BUF ; save RAM bank to P9BUF
EXHL HLBUF ; save HL to HLBUF
:
:
EXHL HLBUF ; restore HLBUF to HL
LDA P9BUF ; restore P9BUF to RAM bank
OUTA P9
INA P10 ; restore register P10 to Acc
RTI

```

} 10 instruction bytes

} 10 instruction bytes

Preliminary

TIME BASE INTERRUPT (TBI)

The time base can be used to generate a single fixed frequency interrupt. Eight types of frequencies can be selected with the "P25" setting.

P25 3 2 1 0
 initial value : 0000

P25	NORMAL operation mode	SLOW operation mode
0 0 x x	Interrupt disable	Interrupt disable
0 1 0 0	Interrupt frequency LXIN / 2 ³ Hz	Reserved
0 1 0 1	Interrupt frequency LXIN / 2 ¹⁵ Hz	Interrupt frequency LXIN / 2 ¹⁵ Hz
0 1 1 0	Interrupt frequency LXIN / 2 ⁵ Hz	Reserved
0 1 1 1	Interrupt frequency LXIN / 2 ¹⁴ Hz	Interrupt frequency LXIN / 2 ¹⁴ Hz
1 1 0 0	Interrupt frequency LXIN / 2 ¹ Hz	Reserved
1 1 0 1	Interrupt frequency LXIN / 2 ⁶ Hz	Interrupt frequency LXIN / 2 ⁶ Hz
1 1 1 0	Interrupt frequency LXIN / 2 ⁸ Hz	Interrupt frequency LXIN / 2 ⁸ Hz
1 1 1 1	Interrupt frequency LXIN / 2 ¹⁰ Hz	Interrupt frequency LXIN / 2 ¹⁰ Hz
1 0 x x	Reserved	Reserved

TIMER / COUNTER (TIMER A, TIMER B)

Timer/counters support three special functions:

1. Even counter
2. Timer.
3. Pulse-width measurement.

These three functions can be executed by 2 timer/counter independently.

With timerA, the counter data is saved in timer register TAH, TAM, TAL. User can set counter initial value and read the counter value by instruction "LDATAH(M,L)" and "STATAH(M,L)". With timer B register is TBH, TBM, TBL and the W/R instruction are "LDATBH (M,L)" and "STATBH (M,L)". The basic structure of timer/counter is composed by two identical counter module, these two modules can be set initial timer or counter value to the timer registers, P28 and P29 are the command registers for timerA and timer B, user can choose different operation modes and internal clock rates by setting these two registers. When timer/counter overflows, it will generate a TRGA(B) interrupt request to interrupt control unit.

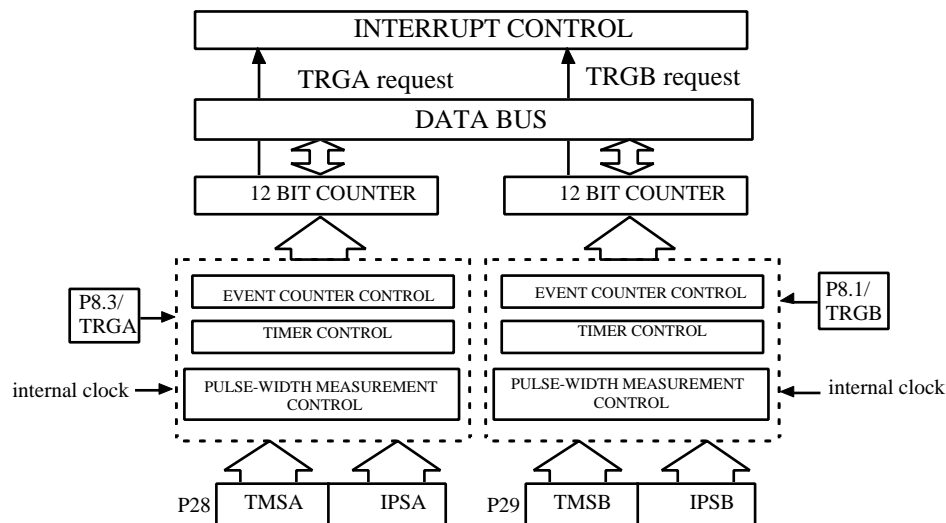

Preliminary

TIMER/COUNTER CONTROL

P8.1/TRGB, P8.3/TRGA are the external timer inputs for timerB and timerA, they are used in event counter and pulse-width measurement mode.

Timer/counter command port: P28 is the command port for timer/counterA and P29 is for the timer/counterB.

P28, P29 3 2 1 0 Initial value : 0000

TMSA(B)	IPSA(B)
---------	---------

TMSA(B)	Mode selection
0 0	Stop
0 1	Event counter mode
1 0	Timer mode
1 1	Pulse width measurement mode

IPSA	Clock rate selection		IPSB	Clock rate selection	
	NORMAL mode	SLOW mode		NORMAL mode	SLOW mode
0 0	LXIN/2 ³ HZ	Reserved	0 0	Depend on high speed timer/counter	
0 1	LXIN/2 ⁷ HZ	LXIN/2 ⁷ HZ	0 1	LXIN/2 ⁵ HZ	LXIN/2 ⁵ HZ
1 0	LXIN/2 ¹¹ HZ	LXIN/2 ¹¹ HZ	1 0	LXIN/2 ⁹ HZ	LXIN/2 ⁹ HZ
1 1	LXIN/2 ¹⁵ HZ	LXIN/2 ¹⁵ HZ	1 1	LXIN/2 ¹³ HZ	LXIN/2 ¹³ HZ

TIMER/COUNTER FUNCTION

Timer/counterA,B are programmable for timer, event counter and pulse width measurement mode. Each timer/counter can execute any of these functions independently.

EVENT COUNTER MODE

Under event counter mode, the timer/counter is increased by one at any rising edge of P8.1/TRGB for timerB (P8.3/TRGA for timer A). When timerB (timerA) counts overflow, it will provide an interrupt request TRGB (TRGA) to interrupt control unit.

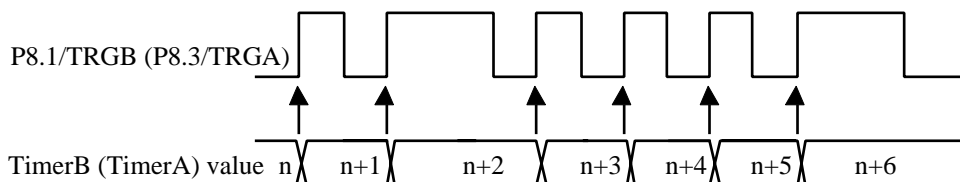

PROGRAM EXAMPLE: Enable timerA with P28

```
LDIA    #0100b;
OUTA    P28    ; Enable timerA with event counter mode
```

Preliminary

TIMER MODE

Under timer mode, the timer/counter is increased by one at any rising edge of internal pulse. User can choose up to 4 types of internal pulse rate by setting IPSB for timerB (IPSA for timerA).

When timer/counter counts overflow, an interrupt request will be sent to interrupt control unit.

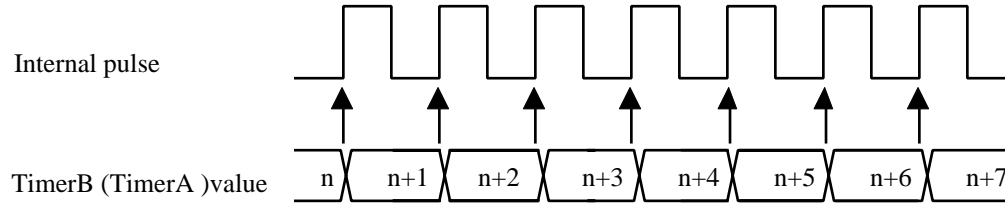

PROGRAM EXAMPLE: To generate TRGA interrupt request after 60 ms with system clock LXIN=32KHz

```
LDIA    #0100B    ;
EXAE    ; enable mask 2
EICIL   110111b  ; interrupt latch ←0, enable EI
LDIA    #0Ah;
STATAL;
LDIA    #00h;
STATAM;
LDIA    #0Fh;
STATAH;
LDIA    #1000B;
OUTA    P28      ; enable timerA with internal pulse rate: LXIN/23 Hz
```

NOTE: The preset value of timer/counter register is calculated as following procedure.

Internal pulse rate: $LXIN/2^3$; $LXIN = 32KHz$

The time of timer counter count one = $2^3 / LXIN = 8/32768=0.244ms$

The number of internal pulse to get timer overflow = $60 ms/0.244ms = 245.901= 0F6h$

The preset value of timer/counter register = $1000h - 0F6h = F0Ah$

PULSE WIDTH MEASUREMENT MODE

Under the pulse width measurement mode, the counter is increased at the rising edge of internal pulse during external timer/counter input (P8.1/TRGB, P8.3/TRGA) in high level, interrupt request is generated as soon as timer/counter count overflow.

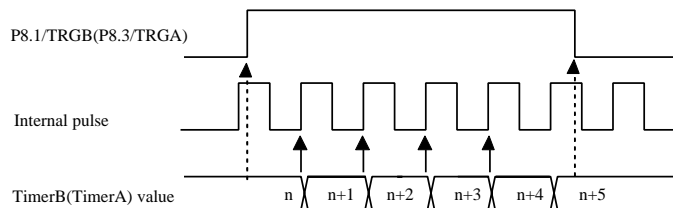

PROGRAM EXAMPLE: Enable timerA by pulse width measurement mode.

```
LDIA    #1100b  ;
OUTA    P28     ; Enable timerA with pulse width measurement mode.
```

Preliminary

INTERRUPT FUNCTION

Six interrupt sources are available, 2 from external interrupt sources and 4 from internal interrupt sources. Multiple interrupts are admitted according to their priority.

Type	Interruptsource	Priority	Interrupt Latch	Interrupt Enablecondition	ProgramROM entry address
External	External interrupt (INT0)	1	IL5	EI=1	002h
Internal	Speech or HTC interrupt (SPI or HTCI)	2	IL4	EI=1, MASK3=1	004h
Internal	TimerA overflow interrupt (TRGA)	3	IL3	EI=1, MASK2=1	006h
Internal	TimerB overflow interrupt (TRGB)	4	IL2	EI=1, MASK1=1	008h
Internal	Time base interrupt (TBI)	5	IL1		00Ah
External	External interrupt (INT1)	6	IL0	EI=1, MASK0=1	00Ch

INTERRUPT STRUCTURE

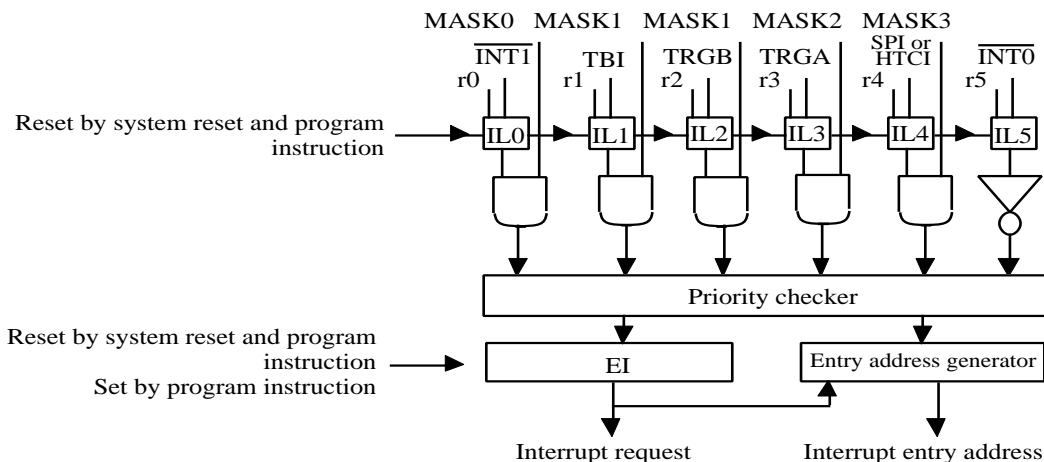

Interrupt controller:

IL0-IL5 : Interrupt latch. Hold all interrupt requests from all interrupt sources. IL's can not be set by program, but can be reset by program or system reset, so IL can only decide which interrupt source can be accepted.

MASK0-MASK3 : Except $\overline{\text{INT0}}$, MASK register may permit or inhibit all interrupt sources.

EI : Enable interrupt Flip-Flop may permit or inhibit all interrupt sources, when interrupt occurs, EI is auto cleared to "0", after RTI instruction is executed, EI is auto set to "1" again.

Priority checker : Check interrupt priority when multiple interrupts occur.

Preliminary

INTERRUPT OPERATION

The procedure of interrupt operation:

1. Push PC and all flags to stack.
2. Set interrupt entry address into PC.
3. Set SF = 1.
4. Clear EI to inhibit other interrupts occur.
5. Clear the IL with which interrupt source has already been accepted.
6. Excute interrupt subroutine from the interrupt entry address.
7. CPU accept RTI, restore PC and flags from stack. Set EI to accept other interrupt requests.

PROGRAM EXAMPLE: To enable interrupt of "INT0, TRGA"

```
LDIA    #0100B ;
EXAE                    ; set mask register "0100b"
EICL    010111B ; enable interrupt F.F. and clear IL3 and IL5
```

INTERRUPT SOURCE SELECTION REGISTER

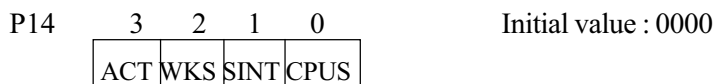

P14.1 is the interrupt source selection register for speech ending interrupt (SPI) and high speed counter overflow interrupt (HTCI) selection. When SINT=0, the program address "0004H" is the interrupt entry address of SPI. When SINT=1, the program address "0004H" is the interrupt entry address of HTCI. P14.0 and P14.2 are the CPU flages (refer to system operation mode). P14.3 is the speech acknowledge signal (refer to speech synthesizer control).

HIGH SPEED COUNTER

EM73A89B has one high speed counter for resistor to frequency oscillation mode, melody mode and auto load timer mode. This function is available for the DUAL and SLOW operation mode. The resistor to frequency oscillation (RFO) circuit as show below :

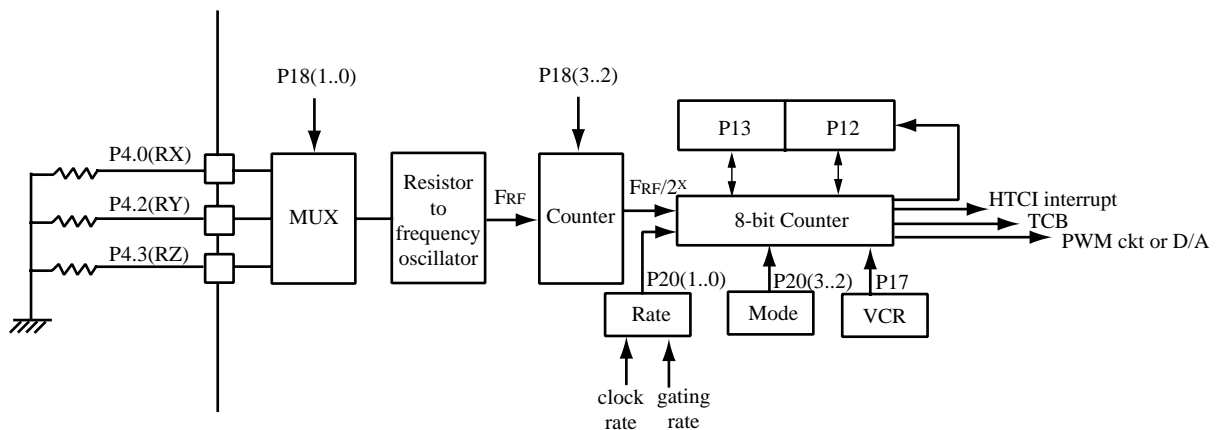

Preliminary

CONTROL OF HIGH SPEED COUNTER

The high speed counter is controlled by the command registers (P20, P18) :

P20 3 2 1 0 Initial value : 0000

MODE	RATE
------	------

MODE	Selection of HTC mode
0 0	Disable HTC
0 1	Auto load timer mode
1 0	Melody mode
1 1	Resistor to frequency oscillation mode

RATE (Hz)	Internal pulse rate / Counter start request frequency	
	Resistor to frequency oscillation mode	Auto load timer mode / Melody mode internal pulse rate
0 0	$LXIN / 2^6$	$CLK / 2^4$
0 1	$LXIN / 2^{10}$	$CLK / 2^5$
1 0	$LXIN / 2^{14}$	$CLK / 2^6$
1 1	$LXIN / 2^{15}$	$CLK / 2^7$

P18 3 2 1 0 Initial value : 0000

RFIP	RFIN
------	------

RFIP	Input frequency of RFO	RFIN	Selection of RFO Pin
0 0	F_{RF}	0 0	Normal I/O
0 1	$F_{RF} / 4$	0 1	P4.0 (RX) for RFO
1 0	$F_{RF} / 16$	1 0	P4.2 (RY) for RFO
1 1	$F_{RF} / 64$	1 1	P4.3 (RZ) for RFO

P12 and P13 are the 8-bit binary counter registers of the HTC. P12 is lower nibble register and P13 is higher nibble register.

P13

3	2	1	0
Higher nibble register			

P12

3	2	1	0
Lower nibble register			

Initial value : 0000 0000

The HTC can be set initial value and send counter value to counter registers (P13 and P12), P20 and P18 are the command ports for HTC, user can choose different operation mode and different internal clockrate by setting the port. The timer/counter increase one at the rising edge of internal pulse. The HTC can generate an overflow interrupt (HTCI) when it overflows. The HTCI can't be generated when the HTC is in the melody mode or disabled.

Preliminary

8-BIT BINARY COUNTER

Write the preset value to the registers

The value of 8-bit binary counter can be presetted by P13 and P12. The value of registers can be loaded into the 8-bit binary counter when the counter starts counting or occurs overflow. When the 8-bit binary counter overflows, the HTCI interrupt will be generated. If you write values to the registers before the next overflow occurs, the preset value can be changed.

Read the count value from the registers

The count value of 8-bit binary counter can be read out from P13 and P12. The value is unstable when you read out the value during counting. Thus, you must disable the counter before reading out the value.

20-BIT COUNTER FUNCTION

The 8-bit binary counter is connected to TCB which is one 12-bit general counter and becomes to the 20-bit counter. The TCB increases one when the 8-bit binary counter overflows and generates an overflow interrupt (TRGB) when the TCB overflows. The TRGB cannot be generated when the HTC is in the melody or disable.

FUNCTION OF HIGH SPEED COUNTER

The HTC has three modes which are RFO mode, melody mode and auto load timer mode.

The HTC is disabled when the CPU is reseted or in the STOP/IDLE operation mode. Users must enable it by yourself when the CPU is waked up.

Resistor to frequency oscillation mode

In this mode, the HTC is counted by the rising edges of input pulses from P4.1 (CS) and the value of window gate width is specified by P20. In this case, the window gate width interval is from the time base output fall to rise and the value of window gate width setting is the same as the time base interrupt frequency. The time base can be generated a fixed frequency interrupt when the time base interrupt (TBI) is enabled. The content of the HTC can be read and initialized by the TBI interrupt service routine.

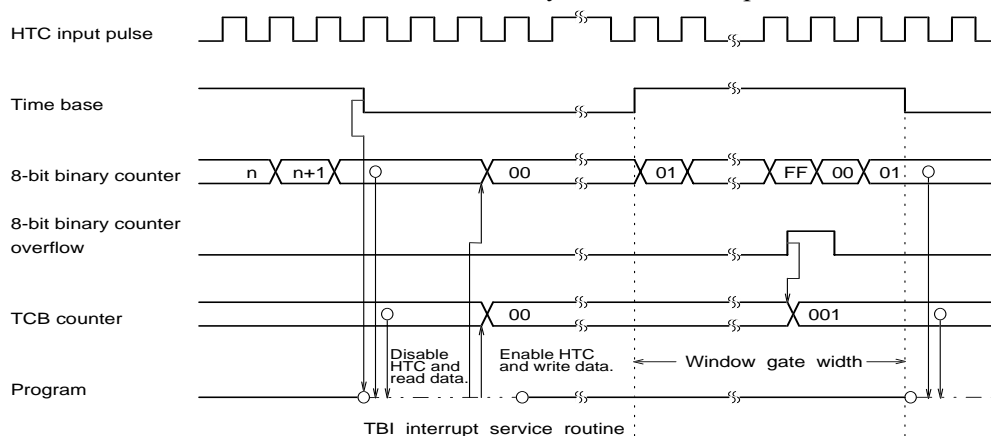

ex. TBI interrupt frequency is $LXIN/2^{15}$ Hz (P25=0101B). The pulse rate of RFO is $LXIN/2^{15}$ Hz (P20=1111B). The window gate width of RFO is $2^{14}/LXIN$ sec. (LXIN=32KHz)

Preliminary

PROGRAM EXAMPLE

```

        DSEG
        ORG      00H

HLBUF: RES      2

P9BUF:  RES      1

RFCON:  RES      1
      :
      CSEG
      ORG      00H
      LBR      MAIN      ; initial jump
      ORG      0AH
      LBR      TBI       ; timebase interrupt vector address
      :
                                ; timebase interrupt service routine
TBI:   OUTA     P10
      INA      P9
      OUT      #0,P9
      STA      P9BUF
      EXHL     HLBUF
      CMP      #00H,RFCON
      B        TBI1
      STD      #01H,RFCON
      LDIA     #00H      ; initial TCB & HTC register
      OUTA     P13
      OUTA     P12
      STATBL
      STATBM
      STATBH
      B        TBIEND
    
```

Preliminary

```

TBI1:  OUTA    P10
        INA    P9
        OUT    #0,P9
        STA    P9BUF
        EXHL   HLBUF
        LDIA   #00H           ; disable RFO before reading the counter value
        OUTA   P20
        INA    P12           ; store the counter value to RAM[00] - RAM[04]
        STA    00H
        INA    P13
        STA    01H
        LDATBL
        STA    02H
        LDATBM
        STA    03H
        LDATBH
        STA    04H

TBIEND: EXHL   HLBUF
        LDA    P9BUF
        OUTA   P9
        INA    P10
        RTI

MAIN:   STD    #00H,RFCON    ; main program
        LDIA   #0001B       ; P4.0 (RX) output
        OUTA   P18
        LDIA   #0010B       ; enable timebase interrupt
        EXAE
        EICIL  0
        LDIA   #1111B       ; the pulse rate of RFO=215/LXIN sec.
        OUTA   P20
        LDIA   #0101B       ; enable timebase, interrupt frequency : LXIN / 215 Hz
        OUTA   P25
        :
    
```

Preliminary

Auto load timer mode

In this mode, there are four different internal pulse rates can be selected by P20. The HTC loads the initial values by the counter registers (P12, P13) and increases at the rising edges of internal pulse generated by the time base. The value of TCB increases one when the high speed counter overflows and generates an overflow interrupt (TRGB) when the TCB overflows. This mode is only available for DUAL operation mode.

PROGRAM EXAMPLE :

```

LDIA          #00H          ; initial TCB & HTC register
STATBL
STATBM
STATBH
OUTA          P13
OUTA          P12
OUTA          P18
LDIA          #0111B        ; enable timer mode, internal pulse rate : CLK/27
OUTA          P20
:
LDIA          #00H          ; disable timer mode
OUTA          P20
INA           P12          ; store the counter value to RAM[00] - RAM[04]
STA           00H
INA           P13
STA           01H
LDATBL
STA           02H
LDATBM
STA           03H
LDATBH
STA           04H
    
```

Melody mode

In the melody mode, HTC will output the square wave to the PWM circuit or D/A converter. The 8-bit tone frequency register is P13 and P12. The tone frequency will be changed when users output the different data to P12. Thus, the data must be output to P13 before P12 when users want to change the 8-bit tone frequency (TF). This mode is only available for DUAL operation mode.

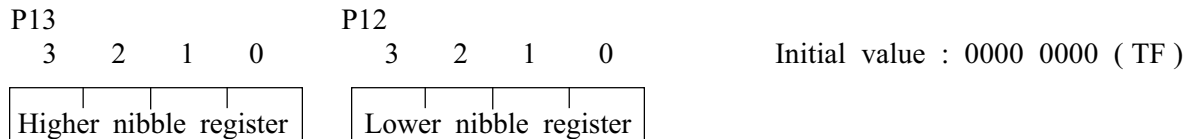

** $F_{TONE} = [(CLK / 2^X) / (100H - TF)] / 2, TF = 0 \sim 255$

** Example : CLK = 4.6MHz, RATE = 10, TF = 11001110 B= 0CEH.
 $F_{TONE} = [(4.6MHz / 2^5) / (100H - 0CEH)] / 2 = 1430 \text{ Hz.}$

Preliminary

Volume control register (P17)

The are 16 levels of volume for sound generator. P17 is the volume control register.

Port17

Initial value : 0000

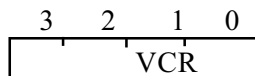

VCR				ts/tp
1	1	1	1	15/16
1	1	1	0	14/16
:	:	:	:	:
0	0	0	1	1/16
0	0	0	0	0/16

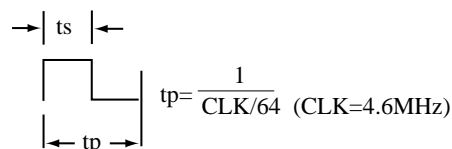

PROGRAM EXAMPLE:

```

LDIA    #0CH
OUTA    P13
LDIA    #0EH
OUTA    P12
LDIA    #0111B           ; volume control
OUTA    P17
LDIA    #1010B           ; 1430 Hz tone output
OUTA    P20
    
```

LCD DRIVER

It can directly drive the liquid crystal display (LCD) and has 64 segment pins, 16 or 32 common pins by mask option. There are total 64x16 or 64x32 dots can be display. The V1~V5, VA and VB pins have to connect the capacitors for LCD voltage multiplier.

	16 common pins	32 common pins
Display dots	16x64 dots	32x64 dots
Bias	1/5 bias	1/5 bias
Duty	1/16 duty	1/32 duty
LCD display RAM	Bank2 (P9=xx10B)	Bank2(P9=xx10B), Bank3(P9=xx11B)
I/O or LCD pin by mask option	COM0..15, SEG0..59, P1[0..3]/SEG63..60	COM0..31, SEG0..43, P7[0..3]/SEG47..44, P6[0..3]/SEG51..48, P5[0..3]/SEG55..52, P2[0..3]/SEG59..56, P1[0..3]/SEG63..60

Preliminary

LCD driver control command register (P27) :

Port27 3 2 1 0 Initial value : 0000



LDC	LCD display control
0	LCD display disable
1	LCD display enable

VREF	Reference voltage	V5(1/5bias)*1
0 0 0	0.85V	4.25V
0 0 1	0.90V	4.50V
0 1 0	0.95V	4.75V
0 1 1	1.00V	5.00V
1 0 0	1.05V	5.25V
1 0 1	Reserved	Reserved
1 1 *	Reserved	Reserved

* : Don't care.

*1: V5 is LCD working voltage (suggestion only).

Example :

```
LDIA #1001B ; enable LCD.
OUTA P27
:
LDIA #0000B ; disable LCD.
OUTA P27
```

LCD display data area:

The LCD display data is stored in the display data area of the data memory (RAM).

Bank 2	Address	0	1	2	3	4	5	6	7	8	9	A	B	C	D	E	F	
P9=xx10B	200-20Fh								COM0									
	210-21Fh								COM1									
	220-22Fh								COM2									
	230-23Fh								COM3									
	240-24Fh								COM4									
	250-25Fh								COM5									
	260-26Fh								COM6									
	270-27Fh								COM7									
	280-28Fh								COM8									
	290-29Fh								COM9									
	2A0-2AFh								COM10									
	2B0-2BFh								COM11									
	2C0-2CFh								COM12									
	2D0-2DFh								COM13									
	2E0-2EFh								COM14									
	2F0-2FFh								COM15									
Bank 3 P9=xx11B	300-30Fh								COM16									
	310-31Fh								COM17									
	320-32Fh								COM18									
	330-33Fh								COM19									
	340-34Fh								COM20									
	350-35Fh								COM21									
	360-36Fh								COM22									
	370-37Fh								COM23									
	380-38Fh								COM24									
	390-39Fh								COM25									
	3A0-3AFh								COM26									
	3B0-3BFh								COM27									
	3C0-3CFh								COM28									
	3D0-3DFh								COM29									
	3E0-3EFh								COM30									
	3F0-3FFh								COM31									

* This specification are subject to be changed without notice.

Preliminary

LCD waveform :

(1)1/32 duty, 1/5 bias

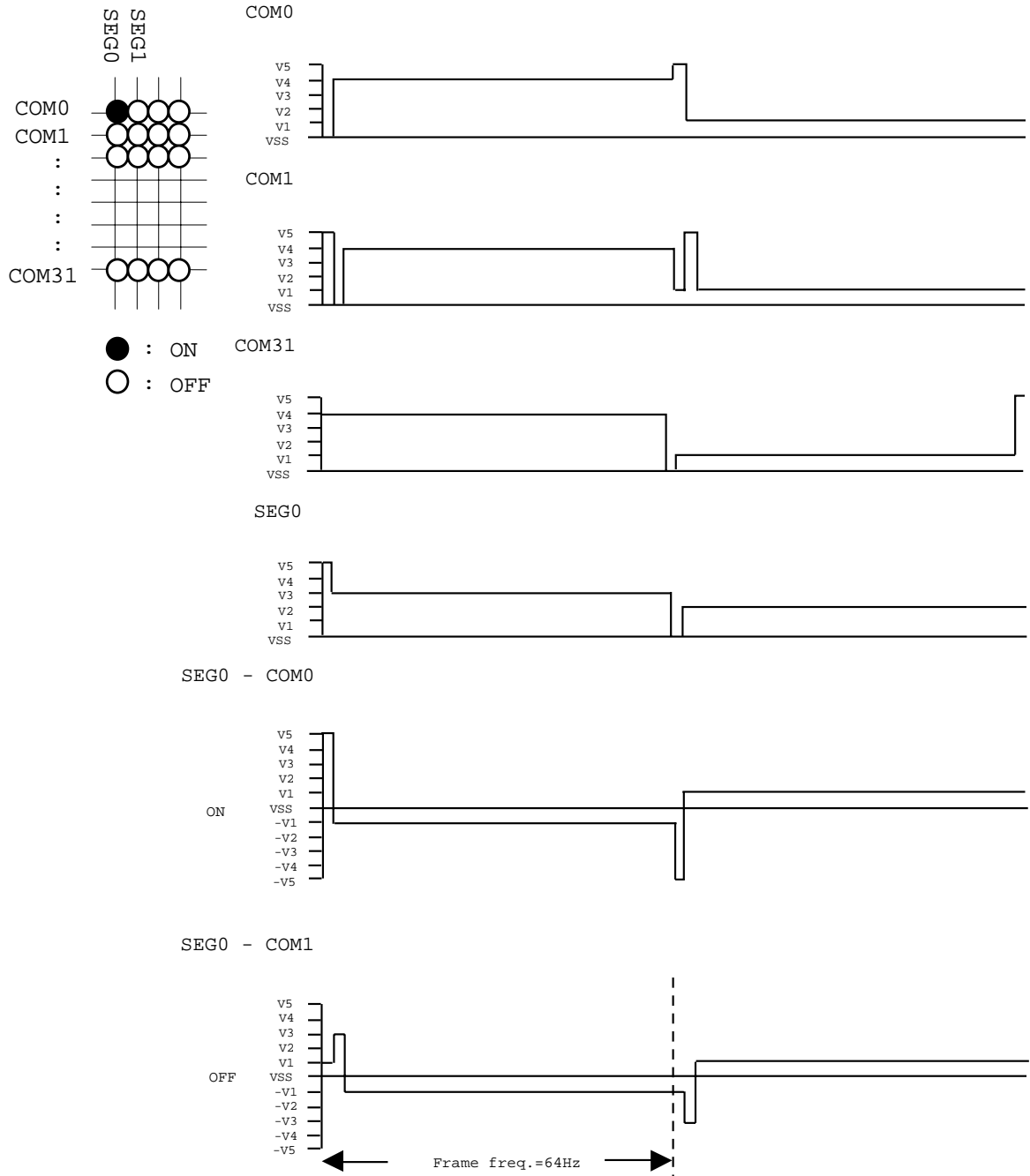

Preliminary

(2)1/16 duty, 1/5 bias

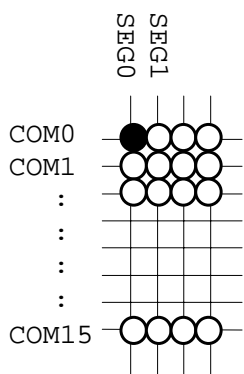

● : ON
○ : OFF

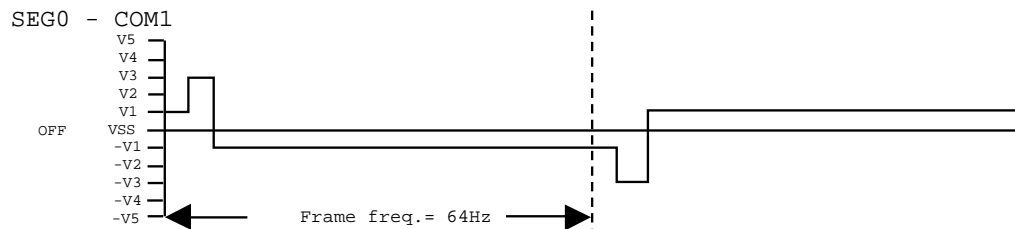
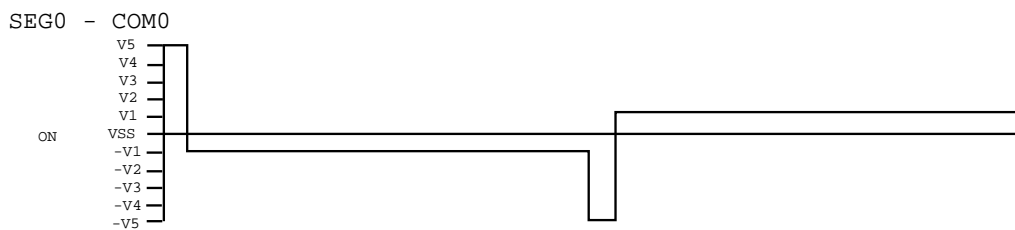
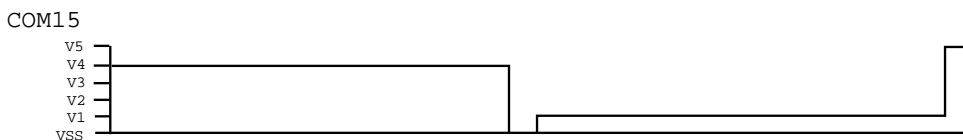
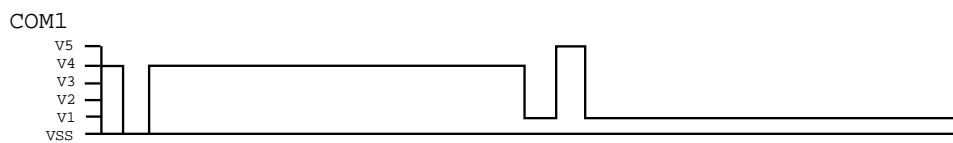
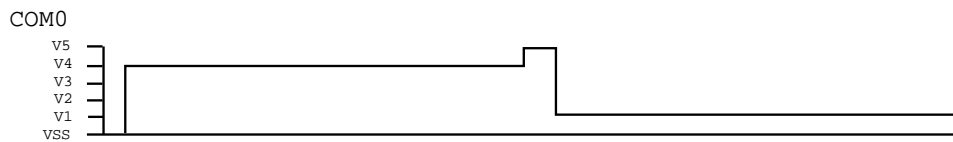

Preliminary

SPEECH SYNTHESIZER

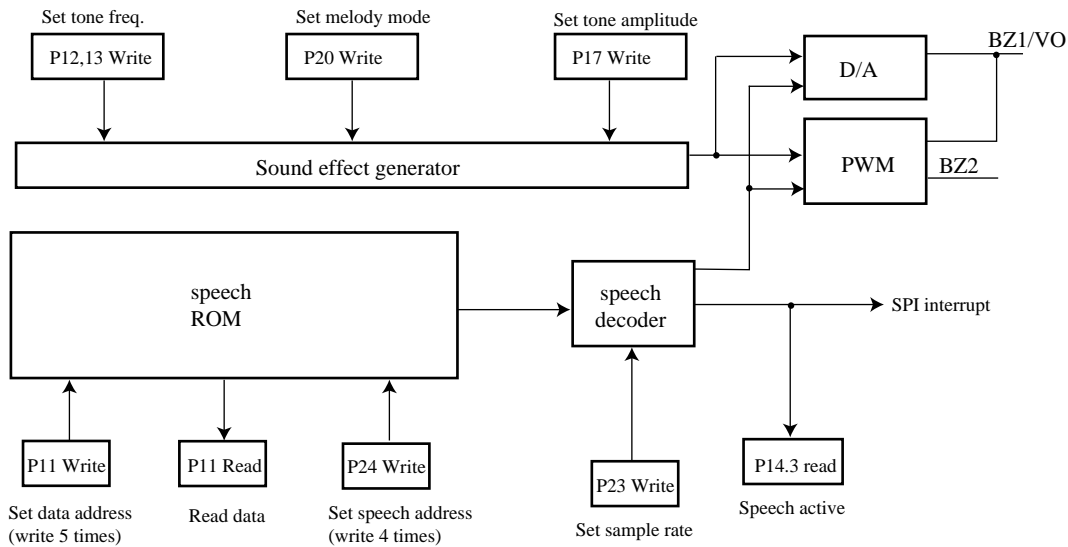

Block diagram of speech and sound effect

EM73A89B speech synthesizer operates as following :

1. Send the speech start address to the address latch by writing P24 four times.
2. Choose the sampling rate, enable the speech synthesizer by writing P23.
3. The ROM address counters send the ROM address A6 .. A19 to the speech ROM.
4. ACT is the speech acknowledge signal. When the speech synthesizer has voice output. ACT is high. When ACT is changed from high to low, the speech synthesizer can generate the speech ending interrupt SPI. The ACT signal can be read from P14.3.

SPEECH SYNTHESIZER CONTROL

Speech sample rate control register (P23 write) :

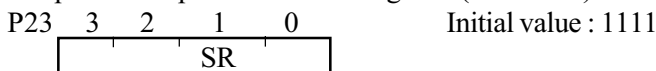

SR	Sample rate selection
0000	CLK/64/2/3
0001	CLK/64/2/4
0010	CLK/64/3/3
0011	CLK/64/3/4
0100	CLK/64/2/7
0101	CLK/64/4/4
0110	CLK/64/6/3
0111	CLK/64/6/4
1***	Disable speech

port 23 -- initialization is "1111".
port 24 -- initialization is pointed to the low-nibble of start address latch.

The frequency of CLK is decided by mask option.

Preliminary

Speech active flag (P14.3 read) :

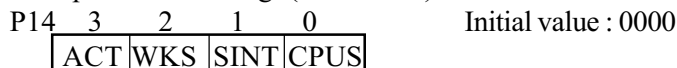

ACT is the speech acknowledge signal. When the speech synthesizer has voice output, ACT is high. When ACT is high → low, the speech synthesizer can generate the speech ending interrupt SPI.

P14(0,2) are CPU status flags (refer to CPU status). P14.1 is the interrupt source selector (refer to interrupt).

Speech start address register (P24 write) :

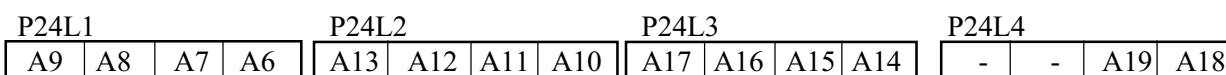
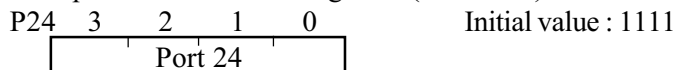

Send the speech start address to the speech synthesizer by writing P24 four times. There is a pointer counter to point the address latch (P24L1, P24L2, P24L3, P24L4). It will increase one when write P24. So, the first time writing P24 to P24L1, the second time is P24L2, the third time is P24L3, the fourth time is P24L4 and the fifth time is P24L1 latch again, ... etc. The pointer counter point to P24L1 when CPU is reset or P23 is written. In the DUAL operation mode, the speech synthesizer is available. In the other operation modes, it is disable.

PROGRAM EXAMPLE:

```

CHIP ROM16K
;-----RAMdefinearea-----
DSEG
ORG 10H
HLBUF: RES 2 ; HL buffer for interrupt
P9BUF: RES 1 ; P9 (RAM bank) buffer for interrupt
:
;-----Constant-----
ACT EQU 143
SPEECH EQU 43200H
:
;-----Interrupt subroutine-----
CSEG
ORG 004H
LBR SPI
:
SPI: OUTA P10 ; save Acc to general purpose register P10
INA P9
OUT #0000B,P9
STA P9BUF ; save RAM bank to P9BUF
EXHL HLBUF ; save HL to HLBUF
:
:
EXHL HLBUF ; restore HLBUF to HL
LDA P9BUF ; resotre P9BUF to RAM bank
OUTA P9
INA P10 ; restore register P10 to Acc
RTI

```

} 10 instruction bytes

} 10 instruction bytes

Preliminary

```

;-----Mainprogram-----
MAIN:
:
LDIA #0000B
OUTA P14 ; select SPI interrupt
LDIA #SPEECH/40H ; set speech start address
OUTA P24
LDIA #SPEECH/400H
OUTA P24
LDIA #SPEECH/4000H
OUTA P24
LDIA #SPEECH/40000H
OUTA P24
LDIA #0011B ; set sampling rate and start playing
OUTA P23
:
WAIT:
TTP P14,3 ; wait speed end
B WAIT
:
    
```

USING SPEECH ROM AS DATA ROM

The speech ROM can be used for speech synthesizer and for data ROM simultaneously. First, write initial address to P11 five times, then you can read P11 to get data, and the address counter increases one automatically. The read operation should be all done before you leave normal mode and change to slow mode.

Get speech ROM data (P11 read) :

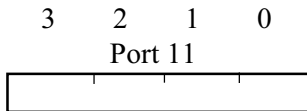

Set speech ROM address (P11 write) :

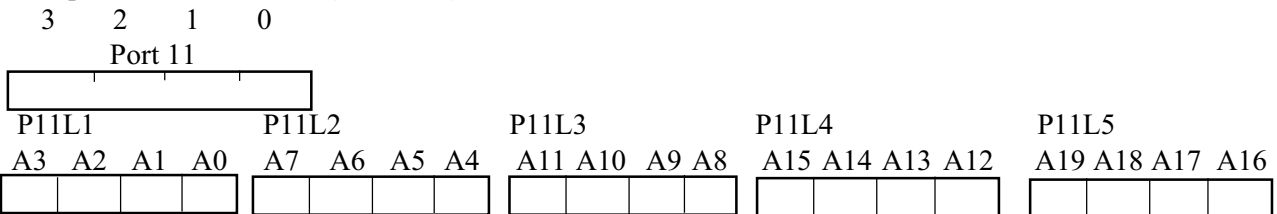

PROGRAM EXAMPLE:

```

DATA_ADR EQU 12345H ; the start address of the speech ROM
:
LDIA #DATA_ADR
OUTA P11
LDIA #DATA_ADR/10H
OUTA P11
LDIA #DATA_ADR/100H
OUTA P11
LDIA #DATA_ADR/1000H
OUTA P11
LDIA #DATA_ADR/10000H
OUTA P11
    
```

Preliminary

```

; READ DATA
INA          P11          ; read DATA_ADR
STA          TEMP
INA          P11
STA          TEMP+1
:
    
```

WATCH-DOG-TIMER (WDT)

Watch-dog-timer can help user to detect the malfunction (runaway) of CPU and give system a timeup signal every certain time. User can use the time up signal to give system a reset signal when system is fail.

This function is available by mask option. If the mask option of WDT is enabled, it will stop counting when CPU is reseted or in the STOP operation mode.

The basic structure of Watch-Dog-Timer control is composed by a 4-stage binary counter and a control unit. The WDT counter counts for a certain time to check the CPU status, if there is no malfunction happened, the counter will be cleared and continue counting. Otherwise, if there is a malfunction happened, the WDT control will send a WDT signal (low active) to reset CPU. The WDT checking period is assign by P21 (WDT command port).

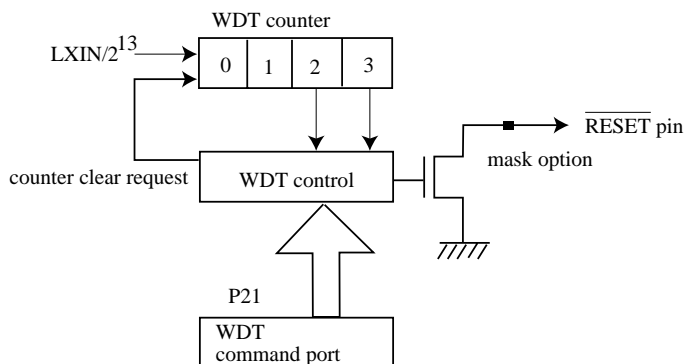

P21 is the control port of watch-dog-timer, and the WDT time up signal is connected to $\overline{\text{RESET}}$.

Port 21 3 2 1 0 Initial value :0000

CWC	*	*	WDT
-----	---	---	-----

CWC	Clear watchdog timer counter
0	Clear counter then return to 1
1	Nothing

WDT	Set watch-dog-timer detect time
0	$3 \times 2^{13}/\text{LXIN} = 3 \times 2^{13}/32\text{K Hz} = 0.75 \text{ sec}$
1	$7 \times 2^{13}/\text{LXIN} = 7 \times 2^{13}/32\text{K Hz} = 1.75 \text{ sec}$

PROGRAM EXAMPLE

To enable WDT with $7 \times 2^{13}/\text{LXIN}$ detection time.

```

LDIA #0001B
OUTA P21 ; set WDT detection time and clear WDT counter
:
:
    
```

Preliminary

RESETTING FUNCTION

When CPU in normal working condition and $\overline{\text{RESET}}$ pin is held in low level for three instruction cycles at least, then CPU begins to initialize the whole internal states, when $\overline{\text{RESET}}$ pin changes to high level, CPU begins to work in normal condition.

The CPU internal state during reset condition is as following table :

Hardware condition in RESET state	Initial value
Program counter	0000h
Status flag	01h
Interrupt enable flip-flop (EI)	00h
MASK0 ,1, 2, 3	00h
Interrupt latch (IL)	00h
P3, 9, 10, 11, 12, 13, 14, 16, 18, 19, 20, 21, 22, 25, 27, 28, 29	00h
P0, 1, 2, 4, 5, 6, 7, 8, 17, 23, 24	0Fh
CLK, LXIN	Start oscillation

The $\overline{\text{RESET}}$ pin is a hysteresis input pin and it has a pull-up resistor available by mask option. The simplest RESET circuit is connect $\overline{\text{RESET}}$ pin with a capacitor to V_{SS} and a diode to V_{DD} .

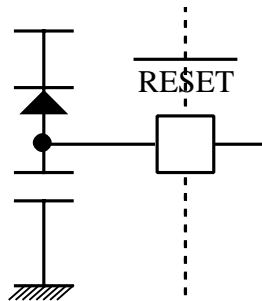

Preliminary

EM73A89B I/O PORT DESCRIPTION :

Port	Input function		Output function		Note
0	E	Input port , wakeup function			
1	E	Input port	E	Output port / LCD segment pins	
2	E	Input port	E	Output port / LCD pins	
3	I	ROM bank selection	I	ROM bank selection	
4	E	Input port	E	Output port / RFO pins	
5	E	Input port	E	Output port / LCD pins	
6	E	Input port	E	Output port / LCD pins	
7	E	Input port	E	Output port / LCD pins	
8	E	Input port, wakeup function, external interrupt input	E	Output port	
9	I	RAM bank selection	I	RAM bank selection	
10	I	General purpose register	I	General purpose register	
11	I	Read data register	I	Data ROM address register	
12		--	I	High speed counter register	Low nibble
13		--	I	High speed counter register	High nibble
14	I	CPU status, ACT flag	I	CPU status, interrupt souce selector	
15		--		--	
16			I	STOP mode control register	
17			I	TONE volume control register	
18			I	HTC control register	
19			I	IDLE mode control register	
20			I	HTC control register	
21			I	WDT control register	
22			I	DUAL/SLOW mode control register	
23			I	Speech sampling rate register	
24			I	Speech start address register	
25			I	Timebase control register	
26				--	
27			I	LCD control register	
28			I	Timer/counter A control register	
29			I	Timer/counter B control register	
30				--	
31				--	

Preliminary

APPLICATION CIRCUIT

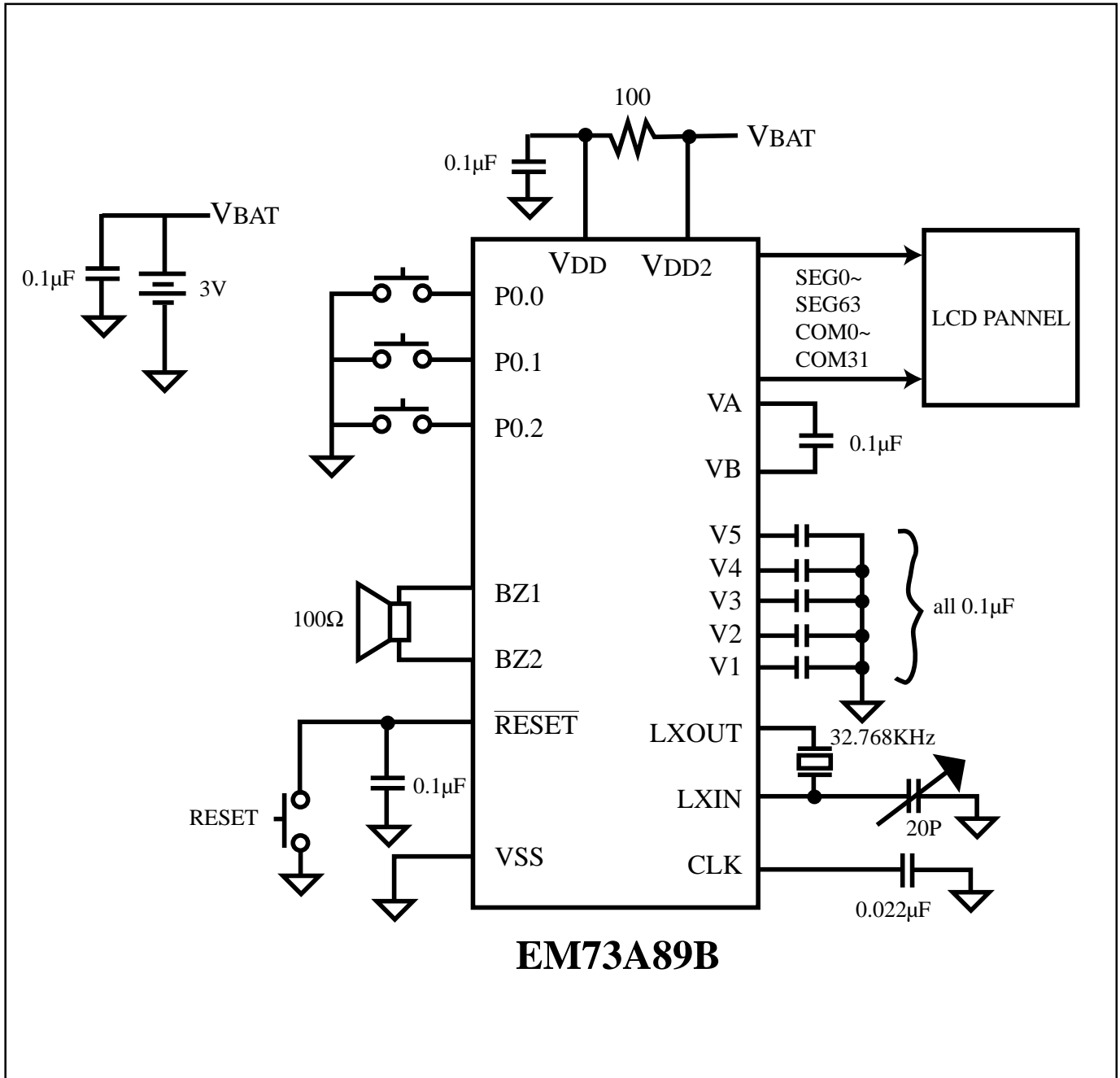

Preliminary

RESET PIN TYPE

TYPE RESET-A

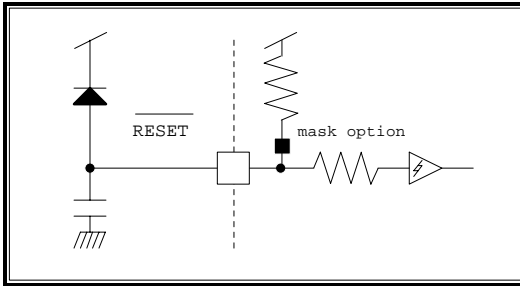

OSCILLATION PIN TYPE

TYPE OSC-B

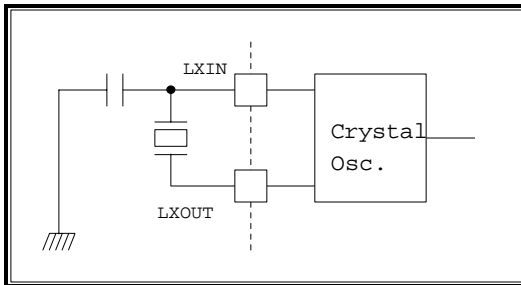

TYPE OSC_G

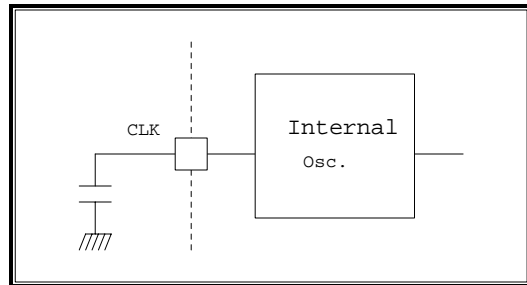

TYPE OSC-H

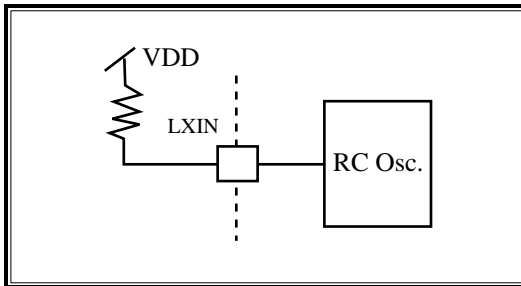

INPUT PIN TYPE

TYPE INPUT-A

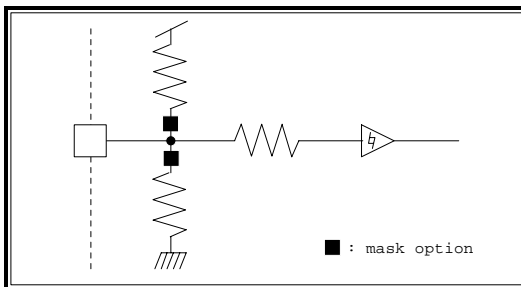

TYPE INPUT-B

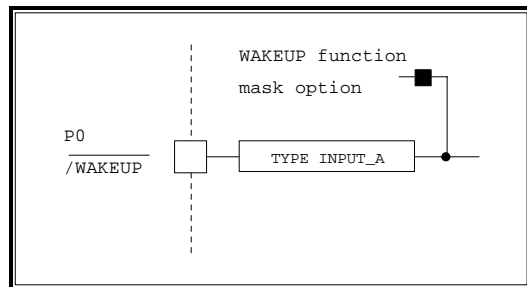

Preliminary

I/O PIN TYPE

TYPE I/O

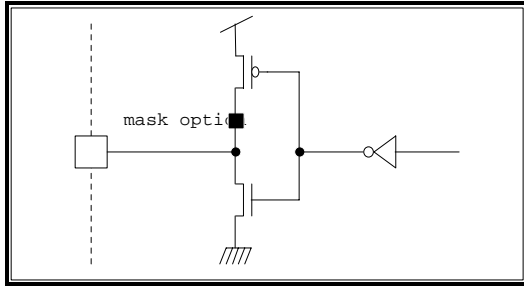

TYPE I/O-P

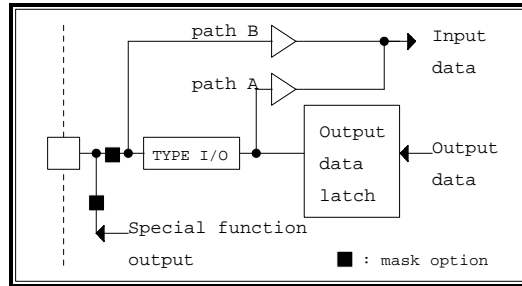

TYPE I/O-Q1

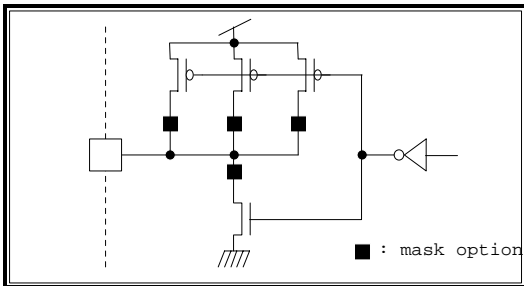

TYPE I/O-X1

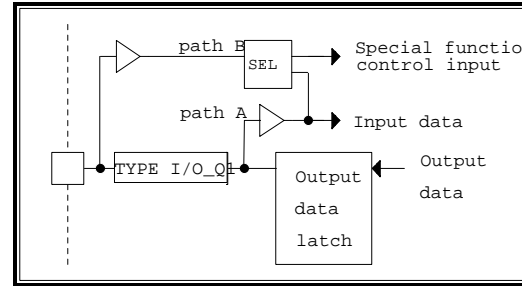

- Path A : For set and clear bit of port instructions, data goes through path A from output data latch to CPU.
- Path B : For input and test instructions, data from output pin go through path B to CPU and the output data latch will be set to high.

Preliminary

PAD DIAGRAM (16 COMMONS)

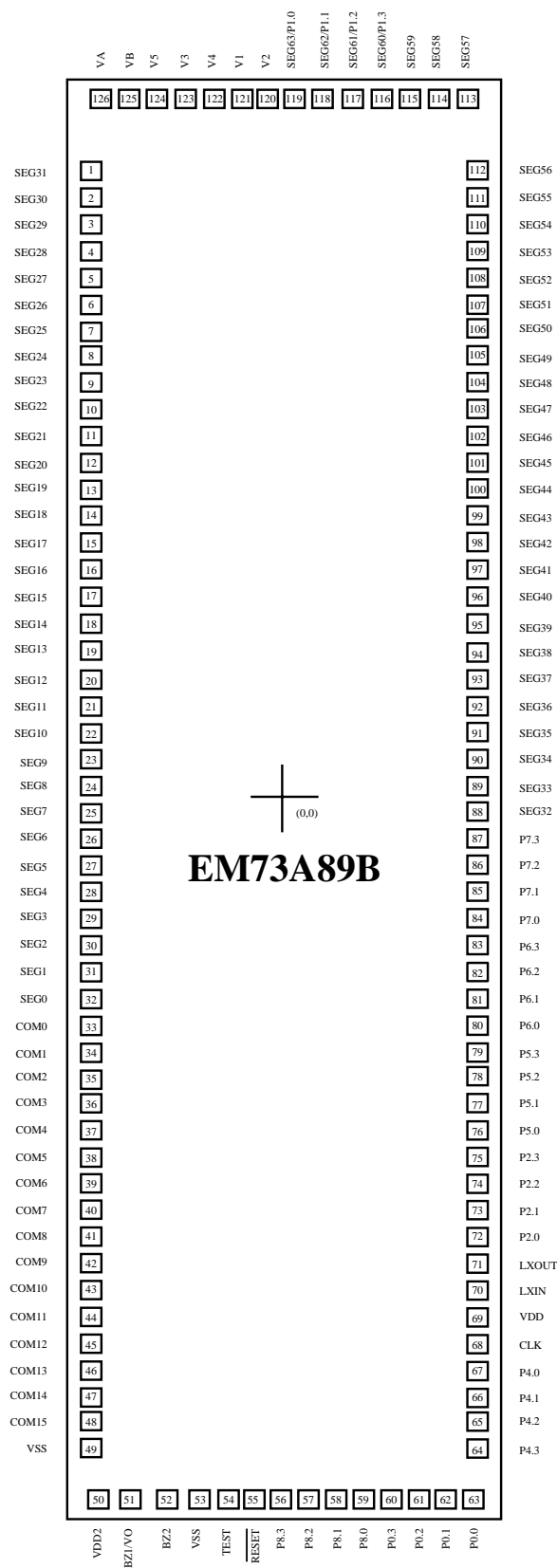

* This specification are subject to be changed without notice.



Preliminary

Pad No.	Symbol	X	Y
1	SEG31	-780.0	2753.9
2	SEG30	-780.0	2623.9
3	SEG29	-780.0	2496.4
4	SEG28	-780.0	2371.4
5	SEG27	-780.0	2246.4
6	SEG26	-780.0	2121.4
7	SEG25	-780.0	1996.4
8	SEG24	-780.0	1873.9
9	SEG23	-780.0	1753.9
10	SEG22	-780.0	1633.9
11	SEG21	-780.0	1513.9
12	SEG20	-780.0	1393.9
13	SEG19	-780.0	1276.4
14	SEG18	-780.0	1161.4
15	SEG17	-780.0	1046.4
16	SEG16	-780.0	931.4
17	SEG15	-780.0	816.4
18	SEG14	-780.0	703.9
19	SEG13	-780.0	593.9
20	SEG12	-780.0	483.9
21	SEG11	-780.0	373.9
22	SEG10	-780.0	263.9
23	SEG9	-780.0	156.4
24	SEG8	-780.0	51.4
25	SEG7	-780.0	-53.6
26	SEG6	-780.0	-158.6
27	SEG5	-780.0	-263.6
28	SEG4	-780.0	-371.1
29	SEG3	-780.0	-481.1
30	SEG2	-780.0	-591.1
31	SEG1	-780.0	-701.1
32	SEG0	-780.0	-811.1
33	COM0	-780.0	-923.6
34	COM1	-780.0	-1038.6
35	COM2	-780.0	-1153.6
36	COM3	-780.0	-1268.6
37	COM4	-780.0	-1383.6
38	COM5	-780.0	-1501.1
39	COM6	-780.0	-1621.1
40	COM7	-780.0	-1741.1



Preliminary

Pad No.	Symbol	X	Y
41	COM8	-780.0	-1861.1
42	COM9	-780.0	-1981.1
43	COM10	-780.0	-2103.6
44	COM11	-780.0	-2228.6
45	COM12	-780.0	-2353.6
46	COM13	-780.0	-2478.6
47	COM14	-780.0	-2603.6
48	COM15	-780.0	-2731.1
49	VSS	-780.0	-2861.1
50	VDD2	-763.3	-3120.0
51	BZ1/VO	-633.2	-3120.0
52	BZ2	-483.2	-3120.0
53	VSS	-353.1	-3120.0
54	TEST	-237.9	-3120.0
55	RESET	-127.9	-3120.0
56	P8.3	-17.9	-3120.0
57	P8.2	92.1	-3120.0
58	P8.1	202.1	-3120.0
59	P8.0	312.1	-3120.0
60	P0.3	422.1	-3120.0
61	P0.2	532.1	-3120.0
62	P0.1	642.1	-3120.0
63	P0.0	759.6	-3120.0
64	P4.3	780.0	-2861.1
65	P4.2	780.0	-2731.1
66	P4.1	780.0	-2603.6
67	P4.0	780.0	-2478.6
68	CLK	780.0	-2353.6
69	VDD	780.0	-2228.6
70	LXIN	780.0	-2103.6
71	LXOUT	780.0	-1981.1
72	P2.0	780.0	-1861.1
73	P2.1	780.0	-1741.1
74	P2.2	780.0	-1621.1
75	P2.3	780.0	-1501.1
76	P5.0	780.0	-1383.6
77	P5.1	780.0	-1268.6
78	P5.2	780.0	-1153.6
79	P5.3	780.0	-1041.1
80	P6.0	780.0	-931.1



Preliminary

Pad No.	Symbol	X	Y
81	P6.1	780.0	-821.1
82	P6.2	780.0	-711.1
83	P6.3	780.0	-601.1
84	P7.0	780.0	-491.1
85	P7.1	780.0	-381.1
86	P7.2	780.0	-271.1
87	P7.3	780.0	-161.1
88	SEG32	780.0	-53.6
89	SEG33	780.0	51.4
90	SEG34	780.0	156.4
91	SEG35	780.0	263.9
92	SEG36	780.0	373.9
93	SEG37	780.0	483.9
94	SEG38	780.0	593.9
95	SEG39	780.0	703.9
96	SEG40	780.0	816.4
97	SEG41	780.0	931.4
98	SEG42	780.0	1046.1
99	SEG43	780.0	1161.4
100	SEG44	780.0	1276.4
101	SEG45	780.0	1393.9
102	SEG46	780.0	1513.9
103	SEG47	780.0	1633.9
104	SEG48	780.0	1753.9
105	SEG49	780.0	1873.9
106	SEG50	780.0	1996.4
107	SEG51	780.0	2121.4
108	SEG52	780.0	2246.4
109	SEG53	780.0	2371.4
110	SEG54	780.0	2496.4
111	SEG55	780.0	2623.9
112	SEG56	780.0	2753.9
113	SEG57	715.0	3120.0
114	SEG58	605.0	3120.0
115	SEG59	495.0	3120.0
116	SEG60/P1.3	385.0	3120.0
117	SEG61/P1.2	275.0	3120.0
118	SEG62/P1.1	165.0	3120.0
119	SEG63/P1.0	55.0	3120.0
120	V2	-55.0	3120.0

Preliminary

Pad No.	Symbol	X	Y
121	V1	-165.0	3120.0
122	V4	-275.0	3120.0
123	V3	-385.0	3120.0
124	V5	-495.0	3120.0
125	VB	-605.0	3120.0
126	VA	-715.0	3120.0

Unit : um

Chip size : 1810 x 6490um

Note : For PCB layout, IC substrate must be floated or connected to Vss.



Preliminary

PAD DIAGRAM (32 COMMONS)

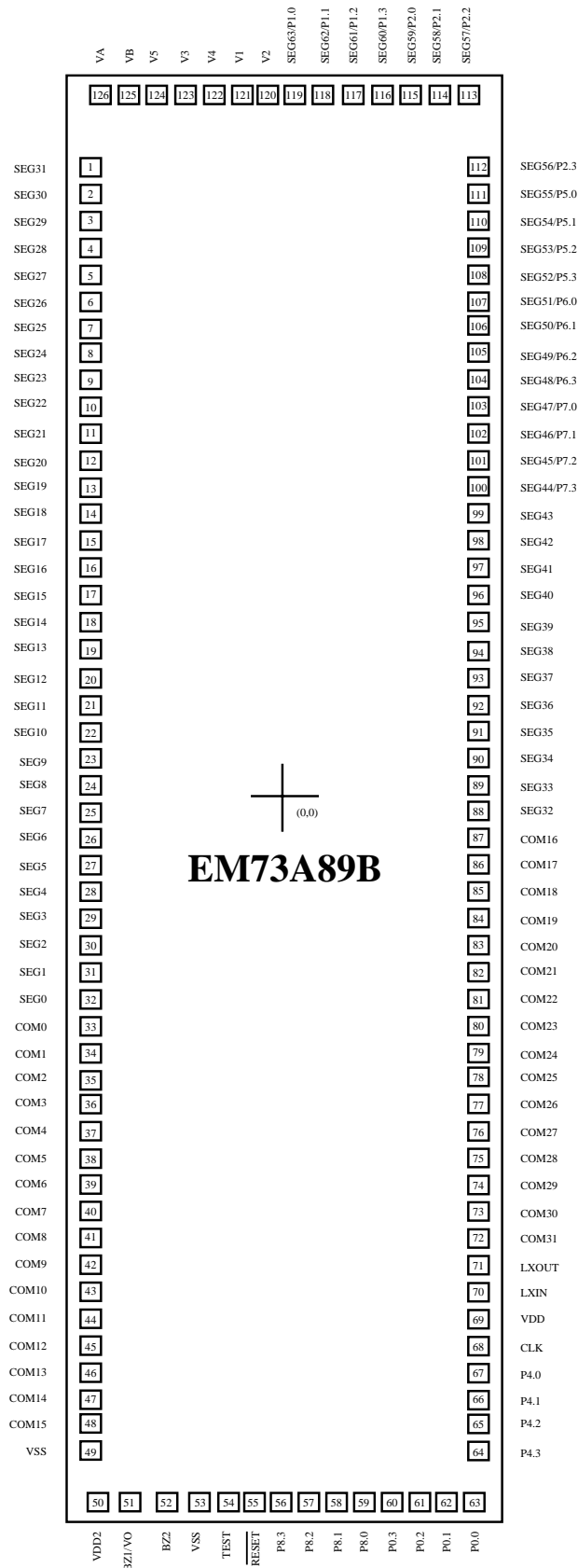

* This specification are subject to be changed without notice.



Preliminary

Pad No.	Symbol	X	Y
1	SEG31	-780.0	2753.9
2	SEG30	-780.0	2623.9
3	SEG29	-780.0	2496.4
4	SEG28	-780.0	2371.4
5	SEG27	-780.0	2246.4
6	SEG26	-780.0	2121.4
7	SEG25	-780.0	1996.4
8	SEG24	-780.0	1873.9
9	SEG23	-780.0	1753.9
10	SEG22	-780.0	1633.9
11	SEG21	-780.0	1513.9
12	SEG20	-780.0	1393.9
13	SEG19	-780.0	1276.4
14	SEG18	-780.0	1161.4
15	SEG17	-780.0	1046.4
16	SEG16	-780.0	931.4
17	SEG15	-780.0	816.4
18	SEG14	-780.0	703.9
19	SEG13	-780.0	593.9
20	SEG12	-780.0	483.9
21	SEG11	-780.0	373.9
22	SEG10	-780.0	263.9
23	SEG9	-780.0	156.4
24	SEG8	-780.0	51.4
25	SEG7	-780.0	-53.6
26	SEG6	-780.0	-158.6
27	SEG5	-780.0	-263.6
28	SEG4	-780.0	-371.1
29	SEG3	-780.0	-481.1
30	SEG2	-780.0	-591.1
31	SEG1	-780.0	-701.1
32	SEG0	-780.0	-811.1
33	COM0	-780.0	-923.6
34	COM1	-780.0	-1038.6
35	COM2	-780.0	-1153.6
36	COM3	-780.0	-1268.6
37	COM4	-780.0	-1383.6
38	COM5	-780.0	-1501.1
39	COM6	-780.0	-1621.1
40	COM7	-780.0	-1741.1



Preliminary

Pad No.	Symbol	X	Y
41	COM8	-780.0	-1861.1
42	COM9	-780.0	-1981.1
43	COM10	-780.0	-2103.6
44	COM11	-780.0	-2228.6
45	COM12	-780.0	-2353.6
46	COM13	-780.0	-2478.6
47	COM14	-780.0	-2603.6
48	COM15	-780.0	-2731.1
49	VSS	-780.0	-2861.1
50	VDD2	-763.3	-3120.0
51	BZ1/VO	-633.2	-3120.0
52	BZ2	-483.2	-3120.0
53	VSS	-353.1	-3120.0
54	TEST	-237.9	-3120.0
55	RESET	-127.9	-3120.0
56	P8.3	-17.9	-3120.0
57	P8.2	92.1	-3120.0
58	P8.1	202.1	-3120.0
59	P8.0	312.1	-3120.0
60	P0.3	422.1	-3120.0
61	P0.2	532.1	-3120.0
62	P0.1	642.1	-3120.0
63	P0.0	759.6	-3120.0
64	P4.3	780.0	-2861.1
65	P4.2	780.0	-2731.1
66	P4.1	780.0	-2603.6
67	P4.0	780.0	-2478.6
68	CLK	780.0	-2353.6
69	VDD	780.0	-2228.6
70	LXIN	780.0	-2103.6
71	LXOUT	780.0	-1981.1
72	COM31	780.0	-1861.1
73	COM30	780.0	-1741.1
74	COM29	780.0	-1621.1
75	COM28	780.0	-1501.1
76	COM27	780.0	-1383.6
77	COM26	780.0	-1268.6
78	COM25	780.0	-1153.6
79	COM24	780.0	-1041.1
80	COM23	780.0	-931.1

Preliminary

Pad No.	Symbol	X	Y
81	COM22	780.0	-821.1
82	COM21	780.0	-711.1
83	COM20	780.0	-601.1
84	COM19	780.0	-491.1
85	COM18	780.0	-381.1
86	COM17	780.0	-271.1
87	COM16	780.0	-161.1
88	SEG32	780.0	-53.6
89	SEG33	780.0	51.4
90	SEG34	780.0	156.4
91	SEG35	780.0	263.9
92	SEG36	780.0	373.9
93	SEG37	780.0	483.9
94	SEG38	780.0	593.9
95	SEG39	780.0	703.9
96	SEG40	780.0	816.4
97	SEG41	780.0	931.4
98	SEG42	780.0	1046.1
99	SEG43	780.0	1161.4
100	SEG44/P7.3	780.0	1276.4
101	SEG45/P7.2	780.0	1393.9
102	SEG46/P7.1	780.0	1513.9
103	SEG47/P7.0	780.0	1633.9
104	SEG48/P6.3	780.0	1753.9
105	SEG49/P6.2	780.0	1873.9
106	SEG50/P6.1	780.0	1996.4
107	SEG51/P6.0	780.0	2121.4
108	SEG52/P5.3	780.0	2246.4
109	SEG53/P5.2	780.0	2371.4
110	SEG54/P5.1	780.0	2496.4
111	SEG55/P5.0	780.0	2623.9
112	SEG56/P2.3	780.0	2753.9
113	SEG57/P2.2	715.0	3120.0
114	SEG58/P2.1	605.0	3120.0
115	SEG59/P2.0	495.0	3120.0
116	SEG60/P1.3	385.0	3120.0
117	SEG61/P1.2	275.0	3120.0
118	SEG62/P1.1	165.0	3120.0
119	SEG63/P1.0	55.0	3120.0
120	V2	-55.0	3120.0



Preliminary

Pad No.	Symbol	X	Y
121	V1	-165.0	3120.0
122	V4	-275.0	3120.0
123	V3	-385.0	3120.0
124	V5	-495.0	3120.0
125	VB	-605.0	3120.0
126	VA	-715.0	3120.0

Unit : um

Chip size : 1810 x 6490um

Note : For PCB layout, IC substrate must be floated or connected to Vss.

Preliminary

ABSOLUTE MAXIMUM RATINGS

Items	Sym.	Ratings	Conditions
Supply Voltage	V_{DD}	-0.5V to 3.6V	
Input Voltage	V_{IN}	-0.5V to $V_{DD}+0.5V$	
Output Voltage	V_O	-0.5V to $V_{DD}+0.5V$	
Power Dissipation	P_D	300mW	$T_{OPR}=50^{\circ}C$
Operating Temperature	T_{OPR}	-30°C to 70°C	
Storage Temperature	T_{STG}	-55°C to 125°C	

RECOMMENDED OPERATING CONDITIONS

Items	Sym.	Ratings	Conditions
Supply Voltage	V_{DD}	2.2V to 3.6V	
Input Voltage	V_{IH}	$0.90 \times V_{DD}$ to V_{DD}	
	V_{IL}	0V to $0.10 \times V_{DD}$	
Operating Frequency	F_C	4.6MHz ~ 9.2MHz	CLK
	F_S	32KHz	LXIN,LXOUT

DC ELECTRICAL CHARACTERISTICS ($V_{DD}=3\pm 0.3V$, $V_{SS}=0V$, $T_{OPR}=25^{\circ}C$)

Parameters	Sym.	Min.	Typ.	Max.	Unit	Conditions
Supply current	I_{DD}	-	0.5	1.2	mA	$V_{DD}=3.3V$, DUAL mode, no load, $F_C=4.6MHz$, $F_S=32KHz$
		-	35	45	μA	$V_{DD}=3.3V$, SLOW mode, $F_S=32KHz$, LCD on
		-	30	40	μA	$V_{DD}=3.3V$, IDLE mode, LCD on
		-	7	12	μA	$V_{DD}=3.3V$, IDLE mode, LCD off
		-	0.1	1	μA	$V_{DD}=3.3V$, STOP mode
Hysteresis voltage	V_{HYS+}	$0.50V_{DD}$	-	$0.75V_{DD}$	V	RESET, P0, P8
	V_{HYS-}	$0.20V_{DD}$	-	$0.40V_{DD}$	V	
Input current	I_{IH}	-	-	± 1	μA	P0, RESET, $V_{DD}=3.3V$, $V_{IH}=3.3/0V$
		-	-	± 1	μA	Open-drain, $V_{DD}=3.3V$, $V_{IH}=3.3/0V$
	I_{IL}	-	-250	-500	μA	Push-pull (normal current push-pull) $V_{DD}=3.3V$, $V_{IL}=0.4V$
		-	-20	-25	μA	Push-pull (low current push-pull) $V_{DD}=3.3V$, $V_{IL}=0.4V$
Output voltage	V_{OH}	2.4	-	-	V	Push-pull, (high current push-pull) $V_{DD}=2.7V$, $I_{OH}=-0.9mA$
		2.0	2.4	-	V	Push-pull, (normal current push-pull) $V_{DD}=2.7V$, $I_{OH}=-40\mu A$
	V_{OL}	-	0.15	0.3	V	$V_{DD}=2.7V$, $I_{OL}=0.9mA$
Leakage current	I_{LO}	-	-	1	μA	Open-drain, $V_{DD}=3.3V$, $V_O=3.3V$
Input resistor	R_{IN}	100	200	300	K Ω	P0, $V_{DD}=3.3V$
		300	600	900	K Ω	RESET, $V_{DD}=3.3V$

Preliminary

Output current of BZ1, BZ2	I_{OH}	30	-	-	mA	$V_{DD}=3.0V, V_{BZ}=1.5V,$ mask option : small size
	I_{OL}	30	-	-	mA	
	I_{OH}	75	-	-	mA	$V_{DD}=3.0V, V_{BZ}=1.5V,$ mask option : large size
	I_{OL}	75	-	-	mA	
Output current of VO		2	3	4	mA	$V_{DD}=3.0V, v_o=0.7V$
LCD reference voltage	V_{REF}	0.765	0.85	0.935	V	$V_{DD}=3.0V, \text{no load}, VREF=000$
		0.81	0.90	0.99	V	$V_{DD}=3.0V, \text{no load}, VREF=001$
		0.855	0.95	1.045	V	$V_{DD}=3.0V, \text{no load}, VREF=010$
		0.9	1.00	1.1	V	$V_{DD}=3.0V, \text{no load}, VREF=011$
		0.945	1.05	1.155	V	$V_{DD}=3.0V, \text{no load}, VREF=100$

Preliminary

INSTRUCTION TABLE

(1) Data Transfer

Mnemonic	Object code (binary)	Operation description	Byte	Cycle	Flag		
					C	Z	S
LDA x	0110 1010 xxxx xxxx	Acc←RAM[x]	2	2	-	Z	1
LDAM	0101 1010	Acc ←RAM[HL]	1	1	-	Z	1
LDAX	0110 0101	Acc←ROM[DP] _L	1	2	-	Z	1
LDAXI	0110 0111	Acc←ROM[DP] _H ,DP+1	1	2	-	Z	1
LDH #k	1001 kkkk	HR←k	1	1	-	-	1
LDHL x	0100 1110 xxxx xx00	LR←RAM[x],HR←RAM[x+1]	2	2	-	-	1
LDIA #k	1101 kkkk	Acc←k	1	1	-	Z	1
LDL #k	1000 kkkk	LR←k	1	1	-	-	1
STA x	0110 1001 xxxx xxxx	RAM[x]←Acc	2	2	-	-	1
STAM	0101 1001	RAM[HL]←Acc	1	1	-	-	1
STAMD	0111 1101	RAM[HL]←Acc, LR-1	1	1	-	Z	C
STAMI	0111 1111	RAM[HL]←Acc, LR+1	1	1	-	Z	C'
STD #k,y	0100 1000 kkkk yyyy	RAM[y]←k	2	2	-	-	1
STDMI #k	1010 kkkk	RAM[HL]←k, LR+1	1	1	-	Z	C'
THA	0111 0110	Acc←HR	1	1	-	Z	1
TLA	0111 0100	Acc←LR	1	1	-	Z	1

(2) Rotate

Mnemonic	Object code (binary)	Operation description	Byte	Cycle	Flag		
					C	Z	S
RLCA	0101 0000	←CF←Acc←	1	1	C	Z	C'
RRCA	0101 0001	→CF→Acc→	1	1	C	Z	C'

(3) Arithmetic operation

Mnemonic	Object code (binary)	Operation description	Byte	Cycle	Flag		
					C	Z	S
ADCAM	0111 0000	Acc←Acc + RAM[HL] + CF	1	1	C	Z	C'
ADD #k,y	0100 1001 kkkk yyyy	RAM[y]←RAM[y] + k	2	2	-	Z	C'
ADDA #k	0110 1110 0101 kkkk	Acc←Acc+k	2	2	-	Z	C'
ADDAM	0111 0001	Acc←Acc + RAM[HL]	1	1	-	Z	C'
ADDH #k	0110 1110 1001 kkkk	HR←HR+k	2	2	-	Z	C'
ADDL #k	0110 1110 0001 kkkk	LR←LR+k	2	2	-	Z	C'
ADDM #k	0110 1110 1101 kkkk	RAM[HL]←RAM[HL] +k	2	2	-	Z	C'
DECA	0101 1100	Acc←Acc-1	1	1	-	Z	C
DECL	0111 1100	LR←LR-1	1	1	-	Z	C
DECM	0101 1101	RAM[HL]←RAM[HL] -1	1	1	-	Z	C
INCA	0101 1110	Acc←Acc + 1	1	1	-	Z	C'

Preliminary

INCL	0111 1110	LR←LR + 1	1	1	-	Z	C'
INCM	0101 1111	RAM[HL]←RAM[HL]+1	1	1	-	Z	C'
SUBA #k	0110 1110 0111 kkkk	Acc←k-Acc	2	2	-	Z	C
SBCAM	0111 0010	Acc←RAM[HL] - Acc - CF'	1	1	C	Z	C
SUBM #k	0110 1110 1111 kkkk	RAM[HL]←k - RAM[HL]	2	2	-	Z	C

(4) Logical operation

Mnemonic	Object code (binary)	Operation description	Byte	Cycle	Flag		
					C	Z	S
ANDA #k	0110 1110 0110 kkkk	Acc←Acc&k	2	2	-	Z	Z'
ANDAM	0111 1011	Acc←Acc & RAM[HL]	1	1	-	Z	Z'
ANDM #k	0110 1110 1110 kkkk	RAM[HL]←RAM[HL]&k	2	2	-	Z	Z'
ORA #k	0110 1110 0100 kkkk	Acc←Acc k	2	2	-	Z	Z'
ORAM	0111 1000	Acc ← Acc RAM[HL]	1	1	-	Z	Z'
ORM #k	0110 1110 1100 kkkk	RAM[HL]←RAM[HL] k	2	2	-	Z	Z'
XORAM	0111 1001	Acc←Acc^RAM[HL]	1	1	-	Z	Z'

(5) Exchange

Mnemonic	Object code (binary)	Operation description	Byte	Cycle	Flag		
					C	Z	S
EXA x	0110 1000 xxxx xxxx	Acc↔RAM[x]	2	2	-	Z	1
EXAH	0110 0110	Acc↔HR	1	2	-	Z	1
EXAL	0110 0100	Acc↔LR	1	2	-	Z	1
EXAM	0101 1000	Acc↔RAM[HL]	1	1	-	Z	1
EXHL x	0100 1100 xxxx xx00	LR↔RAM[x], HR↔RAM[x+1]	2	2	-	-	1

(6) Branch

Mnemonic	Object code (binary)	Operation description	Byte	Cycle	Flag		
					C	Z	S
SBR a	00aa aaaa	If SF=1 then PC←PC ₁₂₋₆ ·a ₅₋₀ else null	1	1	-	-	1
LBR a	1100 aaaa aaaa aaaa	If SF= 1 then PC←a else null	2	2	-	-	1
SLBR a	0101 0101 1100 aaaa aaaa aaaa (a:1000~1FFFh) 0101 0111 1100 aaaa aaaa aaaa (a:0000~0FFFh)	If SF=1 then PC←a else null	3	3	-	-	1

(7) Compare

Mnemonic	Object code (binary)	Operation description	Byte	Cycle	Flag		
					C	Z	S
CMP #k,y	0100 1011 kkkk yyyy	k-RAM[y]	2	2	C	Z	Z'
CMPA x	0110 1011 xxxx xxxx	RAM[x]-Acc	2	2	C	Z	Z'

Preliminary

Mnemonic	Object code (binary)	Operation description	Byte	Cycle	Flag		
					C	Z	S
CMPAM	0111 0011	RAM[HL] _b - Acc	1	1	C	Z	Z'
CMPH #k	0110 1110 1011 kkkk	k - HR	2	2	-	Z	C
CMPIA #k	1011 kkkk	k - Acc	1	1	C	Z	Z'
CMPL #k	0110 1110 0011 kkkk	k-LR	2	2	-	Z	C

(8) Bit manipulation

Mnemonic	Object code (binary)	Operation description	Byte	Cycle	Flag		
					C	Z	S
CLM b	1111 00bb	RAM[HL] _b ← 0	1	1	-	-	1
CLP p,b	0110 1101 11bb pppp	PORT[p] _b ← 0	2	2	-	-	1
CLPL	0110 0000	PORT[LR _{3,2} +4]LR _{1,0} ← 0	1	2	-	-	1
CLR y,b	0110 1100 11bb yyyy	RAM[y] _b ← 0	2	2	-	-	1
SEM b	1111 01bb	RAM[HL] _b ← 1	1	1	-	-	1
SEP p,b	0110 1101 01bb pppp	PORT[p] _b ← 1	2	2	-	-	1
SEPL	0110 0010	PORT[LR _{3,2} +4]LR _{1,0} ← 1	1	2	-	-	1
SET y,b	0110 1100 01bb yyyy	RAM[y] _b ← 1	2	2	-	-	1
TF y,b	0110 1100 00bb yyyy	SF ← RAM[y] _b '	2	2	-	-	*
TFA b	1111 10bb	SF ← Acc _b '	1	1	-	-	*
TFM b	1111 11bb	SF ← RAM[HL] _b '	1	1	-	-	*
TFP p,b	0110 1101 00bb pppp	SF ← PORT[p] _b '	2	2	-	-	*
TFPL	0110 0001	SF ← PORT[LR _{3,2} +4]LR _{1,0} '	1	2	-	-	*
TT y,b	0110 1100 10bb yyyy	SF ← RAM[y] _b	2	2	-	-	*
TTP p,b	0110 1101 10bb pppp	SF ← PORT[p] _b	2	2	-	-	*

(9) Subroutine

Mnemonic	Object code (binary)	Operation description	Byte	Cycle	Flag		
					C	Z	S
LCALL a	0100 0aaa aaaa aaaa	STACK[SP] ← PC, SP ← SP - 1, PC ← a	2	2	-	-	-
SCALL a	1110 mnm	STACK[SP] ← PC, SP ← SP - 1, PC ← a, a = 8n + 6 (n = 1~15), 0086h (n = 0)	1	2	-	-	-
RET	0100 1111	SP ← SP + 1, PC ← STACK[SP]	1	2	-	-	-

(10) Input/output

Mnemonic	Object code (binary)	Operation description	Byte	Cycle	Flag		
					C	Z	S
INA p	0110 1111 0100 pppp	Acc ← PORT[p]	2	2	-	Z	Z'
INM p	0110 1111 1100 pppp	RAM[HL] ← PORT[p]	2	2	-	-	Z'
OUT #k,p	0100 1010 kkkk pppp	PORT[p] ← k	2	2	-	-	1
OUTA p	0110 1111 000p pppp	PORT[p] ← Acc	2	2	-	-	1
OUTM p	0110 1111 100p pppp	PORT[p] ← RAM[HL]	2	2	-	-	1

Preliminary

(11) Flag manipulation

Mnemonic	Object code (binary)	Operation description	Byte	Cycle	Flag		
					C	Z	S
TFCFC	0101 0011	SF←CF', CF←0	1	1	0	-	*
TTCFS	0101 0010	SF←CF, CF←1	1	1	1	-	*
TZS	0101 1011	SF←ZF	1	1	-	-	*

(12) Interrupt control

Mnemonic	Object code (binary)	Operation description	Byte	Cycle	Flag		
					C	Z	S
CIL r	0110 0011 11rr rrrr	IL←IL & r	2	2	-	-	1
DICIL r	0110 0011 10rr rrrr	EIF←0,IL←IL&r	2	2	-	-	1
EICIL r	0110 0011 01rr rrrr	EIF←1,IL←IL&r	2	2	-	-	1
EXAE	0111 0101	MASK↔Acc	1	1	-	-	1
RTI	0100 1101	SP←SP+1,FLAG.PC ←STACK[SP],EIF ←1	1	2	*	*	*

(13) CPU control

Mnemonic	Object code (binary)	Operation description	Byte	Cycle	Flag		
					C	Z	S
NOP	0101 0110	no operation	1	1	-	-	-

(14) Timer/Counter & Data pointer & Stack pointer control

Mnemonic	Object code (binary)	Operation description	Byte	Cycle	Flag		
					C	Z	S
LDADPL	0110 1010 1111 1100	Acc←[DP] _L	2	2	-	Z	1
LDADPM	0110 1010 1111 1101	Acc←[DP] _M	2	2	-	Z	1
LDADPH	0110 1010 1111 1110	Acc←[DP] _H	2	2	-	Z	1
LDASP	0110 1010 1111 1111	Acc←SP	2	2	-	Z	1
LDATAL	0110 1010 1111 0100	Acc←[TA] _L	2	2	-	Z	1
LDATAM	0110 1010 1111 0101	Acc←[TA] _M	2	2	-	Z	1
LDATAH	0110 1010 1111 0110	Acc←[TA] _H	2	2	-	Z	1
LDATBL	0110 1010 1111 1000	Acc←[TB] _L	2	2	-	Z	1
LDATBM	0110 1010 1111 1001	Acc←[TB] _M	2	2	-	Z	1
LDATBH	0110 1010 1111 1010	Acc←[TB] _H	2	2	-	Z	1
STADPL	0110 1001 1111 1100	[DP] _L ←Acc	2	2	-	-	1
STADPM	0110 1001 1111 1101	[DP] _M ←Acc	2	2	-	-	1
STADPH	0110 1001 1111 1110	[DP] _H ←Acc	2	2	-	-	1
STASP	0110 1001 1111 1111	SP←Acc	2	2	-	-	1
STATAL	0110 1001 1111 0100	[TA] _L ←Acc	2	2	-	-	1
STATAM	0110 1001 1111 0101	[TA] _M ←Acc	2	2	-	-	1
STATAH	0110 1001 1111 0110	[TA] _H ←Acc	2	2	-	-	1
STATBL	0110 1001 1111 1000	[TB] _L ←Acc	2	2	-	-	1
STATBM	0110 1001 1111 1001	[TB] _M ←Acc	2	2	-	-	1
STATBH	0110 1001 1111 1010	[TB] _H ←Acc	2	2	-	-	1

* This specification are subject to be changed without notice.

Preliminary

**** SYMBOL DESCRIPTION

Symbol	Description	Symbol	Description
HR	H register	LR	L register
PC	Program counter	DP	Data pointer
SP	Stack pointer	STACK[SP]	Stack specified by SP
A _{CC}	Accumulator	FLAG	All flags
CF	Carry flag	ZF	Zero flag
SF	Status flag	EI	Enable interrupt register
IL	Interrupt latch	MASK	Interrupt mask
PORT[p]	Port (address : p)	TA	Timer/counter A
TB	Timer/counter B	RAM[HL]	Data memory (address : HL)
RAM[x]	Data memory (address : x)	ROM[DP] _L	Low 4-bit of program memory
ROM[DP] _H	High 4-bit of program memory	[DP] _L	Low 4-bit of data pointer register
[DP] _M	Middle 4-bit of data pointer register	[DP] _H	High 4-bit of data pointer register
[TA] _L ([TB] _L)	Low 4-bit of timer/counter A (timer/counter B) register	[TA] _M ([TB] _M)	Middle 4-bit of timer/counter A (timer/counter B) register
[TA] _H ([TB] _H)	High 4-bit of timer/counter A (timer/counter B) register	LR ₁₋₀	Contents of bit assigned by bit 1 to 0 of LR
LR ₃₋₂	Bit 3 to 2 of LR	a ₅₋₀	Bit 5 to 0 of destination address for branch instruction
PC ₁₂₋₆	Bit 12 to 6 of program counter	←	Transfer
↔	Exchange	+	Addition
-	Substraction	&	Logic AND
	Logic OR	^	Logic XOR
!	Inverse operation	.	Concatenation
#k	4-bit immediate data	x	8-bit RAM address
y	4-bit zero-page address	p	4-bit or 5-bit port address
b	Bit address	r	6-bit interrupt latch