

PRODUCT SPECIFICATION

COSMO ELECTRONICS CO., LTD.	PHOTO MOS RELAYS: KAQY210SB	SHEET 1 OF 7
---------------------------------------	---------------------------------------	--------------

● OUTSIDE DIMENSION :

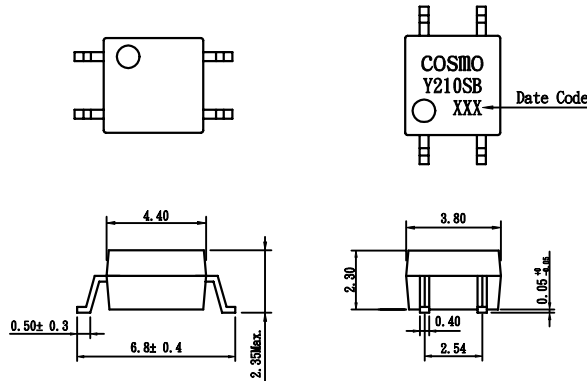

Unit:mm
Tolerance:± 0.2 mm

● Turn on/Turn off time

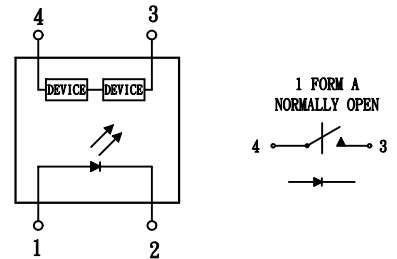
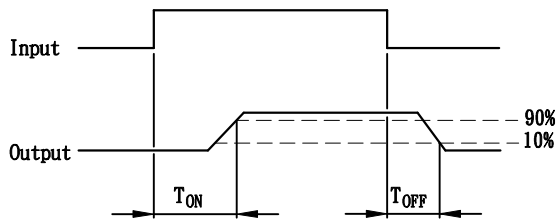

Absolute Maximum Ratings ($T_A=25^\circ\text{C}$)

Emitter (Input)

Reverse Voltage	5.0V
Continuous Forward Current	50mA
Peak Forward Current (1s)	1A
Power Dissipation.	100mW
Derate Linearly from 25°C	1.3mW/ $^\circ\text{C}$

Detector (Output)

Output Breakdown Voltage	± 350V
Continuous Load Current	± 130mA
Power Dissipation	500mW

General Characteristics

Isolation Test Voltage.	1500VAC _{RMS}
Isolation Resistance	
$V_{10}=500\text{V}, T_A=25^\circ\text{C}$	$\geq 10^{10}\Omega$
Total Power Dissipation	550mW

Derate Linearly from 25°C	2.5mW/ $^\circ\text{C}$
Storage Temperature Range	-40 to +150 $^\circ\text{C}$
Operating Temperature Range.	-40 to +85 $^\circ\text{C}$
Junction Temperature	100 $^\circ\text{C}$
Soldering Temperature, 2mm from case, 10 sec.	260 $^\circ\text{C}$

PRODUCT SPECIFICATION

COSMO ELECTRONICS CO., LTD.	PHOTO MOS RELAYS: KAQY210SB	SHEET 2 OF 7
---------------------------------------	---------------------------------------	--------------

Characteristics

(T_A = 25° C)

Description	Symbol	Min.	Typ.	Max.	Unit	Test Condition
Emitter (Input)						
Forward Voltage	V _F		1.2	1.5	V	I _F = 10mA
Operation Input Current	I _{FON}			5	mA	V _L = ± 20V, I _L = 100mA, t = 10 ms
Recovery Input Current	I _{FOFF}	0.05			mA	V _L = ± 20V, I _L = <5uA
Detector (Output)						
Output Breakdown Voltage	V _B	350			V	I _B = 50uA
Output Off-State Leakage	I _{T(OFF)}		0.7	2	uA	V _T = 100V, I _F = 0mA
I/O Capacitance	C _{ISO}		6		pF	I _F = 0, f = 1MHz
ON Resistance	R _{ON}		28	35	Ω	I _L = 100mA, I _F = 10mA
Turn-on Time	T _{ON}		0.1	0.5	ms	I _F = 10mA, V _L = ± 20V
Turn-off Time	T _{OFF}		0.3	0.5	ms	t = 10ms, I _L = ± 100mA

Mos Relay Schematic and Wiring Diagrams

Type	Schematic	Output configuration	Load	Con-nection	Wiring diagram
KAQY210SB		1a	AC/DC	-	

PRODUCT SPECIFICATION

COSMO ELECTRONICS CO., LTD.	PHOTO MOS RELAYS: KAQY210SB	SHEET 3 OF 7
---------------------------------------	---------------------------------------	---------------------

DATA CURVE

Load current vs. ambient temperature
Allowable ambient temperature:
-40° C+85° C

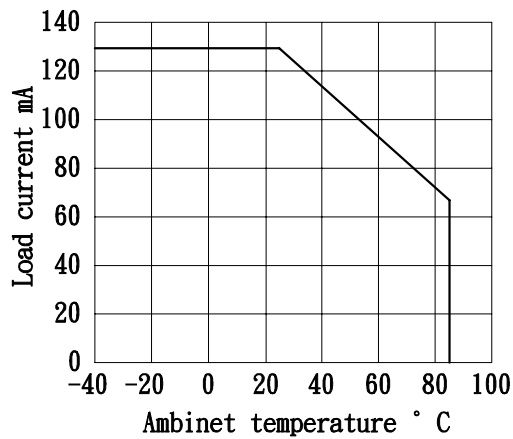

On resistance vs. ambient temperature
Across terminals 3 and 4 pin
LED current: 5mA
Continuous load current: 130 mA(DC)

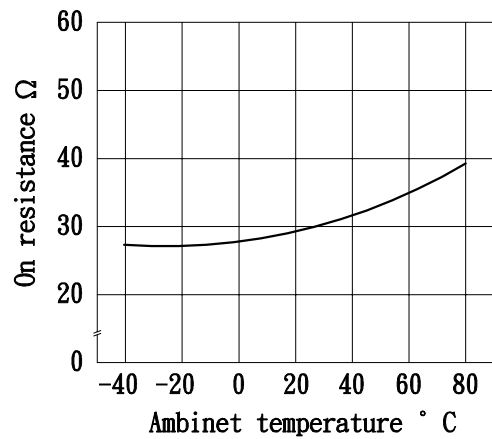

Turn on time vs. ambient temperature
Load voltage 350 V(DC)
LED current :5mA
Continuous load current: 130mA(DC)

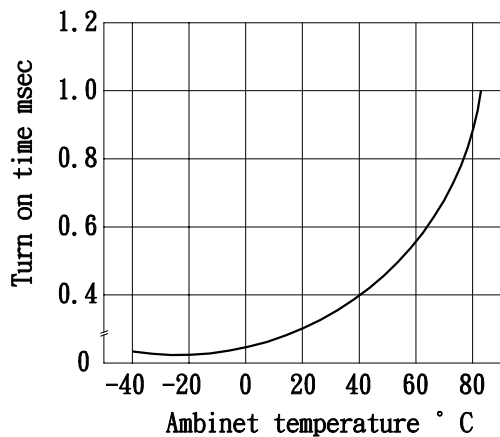

Turn off time vs. ambient temperature
LED current: 5mA; Load voltage: 350V(DC)
Continuous load current: 130mA(DC)

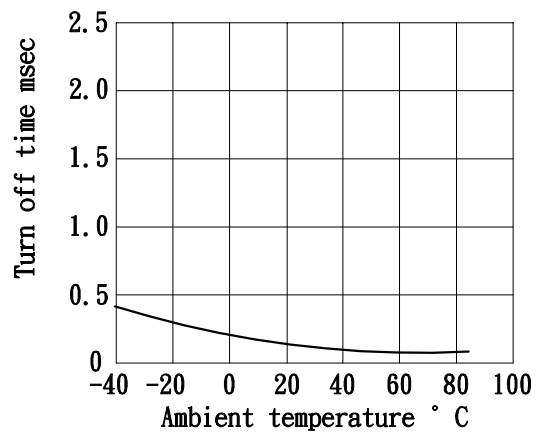

PRODUCT SPECIFICATION

<p>COSMO ELECTRONICS CO., LTD.</p>	<p>PHOTO MOS RELAYS: KAQY210SB</p>	<p>SHEET 4 OF 7</p>
---	---	---------------------

LED operate vs. ambient temperature
Load voltage: 350V(DC)
Continuous load current: 130mA(DC)

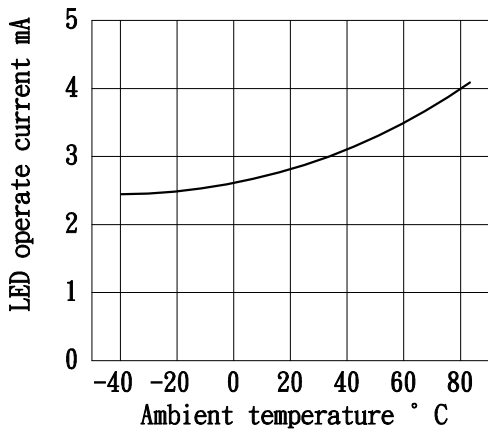

LED turn off current vs. ambient temperature
Load voltage: 350V(DC)
Continuons load current: 130mA(DC)

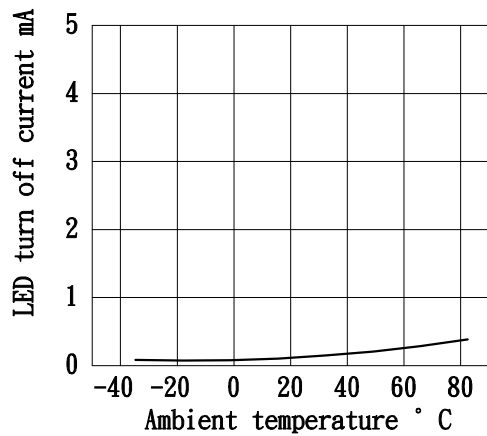

LED dropout voltage vs. ambient temperature
LED current: 5 to 50mA

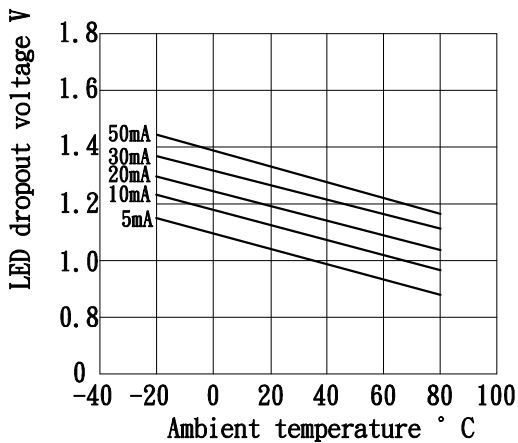

Voltage vs. current characteristics of output at MOS FET portion
Measured portion: across terminals 3 and 4 pin
Ambient temperature: 25° C

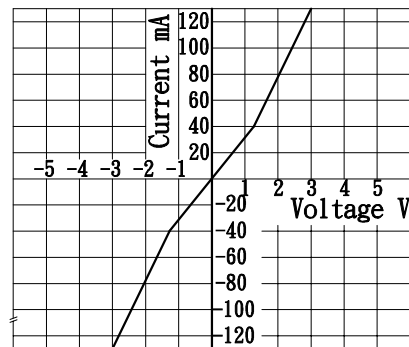

PRODUCT SPECIFICATION

COSMO

ELECTRONICS CO., LTD.

PHOTO MOS RELAYS:

KAQY210SB

SHEET 5 OF 7

LED forward current vs. turn on time
Across terminals 3 and 4pin; Load voltage: 350V(DC); Continuous load current: 130mA(DC); Ambient temperature: 25° C

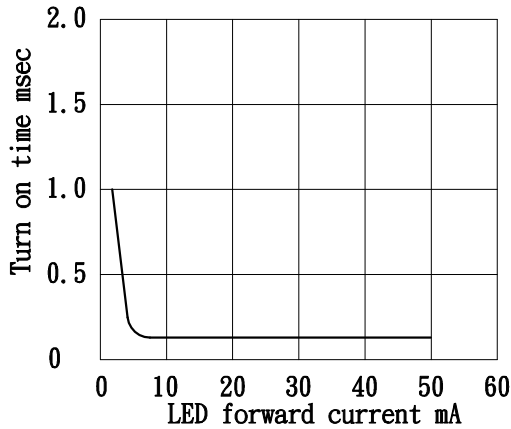

Off state leakage current
Across terminals 3 and 4pin
Ambient temperature: 25° C

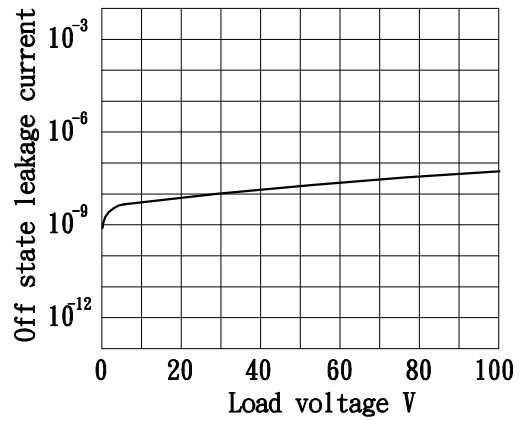

LED forward current vs. turn off time
Across terminals 3 and 4pin; Load voltage: 350V(DC); Continuous load current: 130 mA(DC); Ambient temperature: 25° C

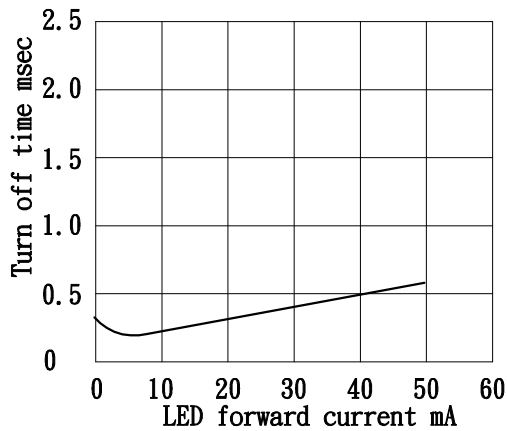

Applied voltage vs. output capacitance
Across terminals 3 and 4pin
Frequency: 1MHz; Ambient temperature: 25° C

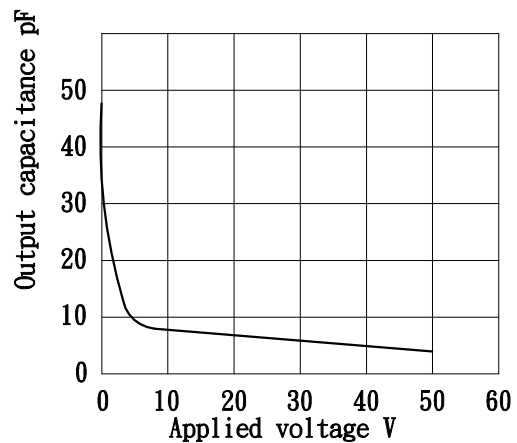

PRODUCT SPECIFICATION

COSMO ELECTRONICS CO., LTD.	PHOTO MOS RELAYS: KAQY210SB	SHEET 6 OF 7
---------------------------------------	---------------------------------------	--------------

USING METHODS

Examples of resistance value to control LED forward current I_F

Photo MOSRELAY

($I_F = 5\text{mA}$)

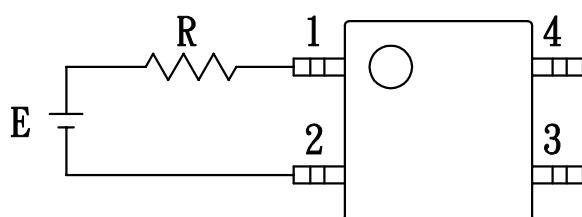

E	R
3.3V	Approx. 240 ohm
5V	Approx. 540 ohm
12V	Approx. 1.8K ohm
15V	Approx. 2.4K ohm
24V	Approx. 4K ohm

- (1) LED forward current must be more than 5mA, at E min.
- (2) LED forward current must be less than 50mA, at E max.

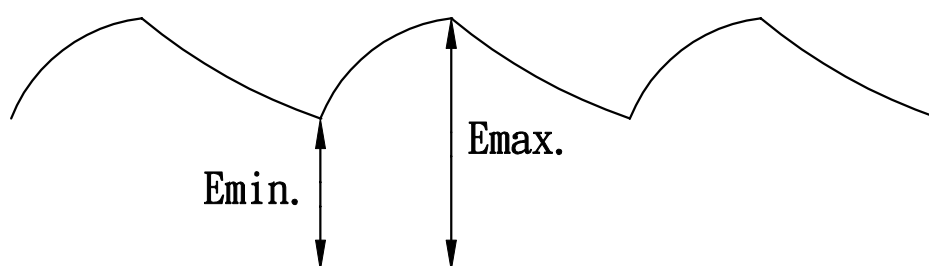

PRODUCT SPECIFICATION

COSMO ELECTRONICS CO., LTD.	PHOTO MOS RELAYS: KAQY210SB	SHEET 7 OF 7
---------------------------------------	---------------------------------------	--------------

USING METHODS

Regulate the spike voltage generated on the inductive load as follows

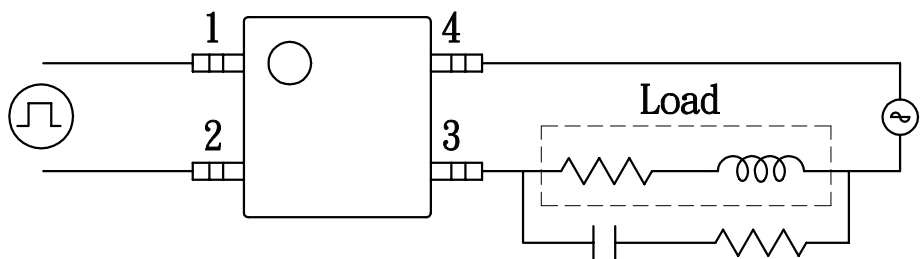
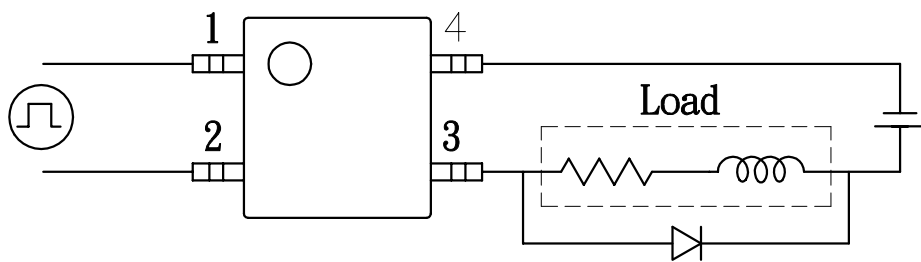

R-C Snubber