

250W FLIP CHIP TVS ARRAY



0402 PACKAGE

DESCRIPTION

The P0402FCxxC Series Flip Chips employ advanced silicon P/N junction technology for unmatched board-level transient voltage protection against Electrostatic Discharge (ESD) and Electrical Fast Transients (EFT). Developed specifically for high-density circuit protection, this series meets the IEC 61000-4-2 and 61000-4-4 requirements. These devices are ideally suited for handheld devices, PCMCIA and SMART cards.

This series provides ESD protection greater than 25 kilovolts with a peak pulse power dissipation of 250 Watts per line for an 8/20 μ s waveform. In addition, the P0402FCxxC series features superior clamping performance, low leakage current characteristics and a response time of less than a nanosecond. Their low inductance virtually eliminates overshoot voltage due to package inductance.

FEATURES

- Compatible with IEC 61000-4-2 (ESD): Air 15kV, Contact 8kV
- Compatible with IEC 61000-4-4 (EFT): 40A, 5/50ns
- ESD Protection > 25 kilovolts
- Available in Voltages Ranging from 3.3V to 36V
- 250 Watts Peak Pulse Power per Line (tp = 8/20 μ s)
- Protection for 1 Line
- RoHS Compliant
- REACH Compliant

APPLICATIONS

- Cellular Phones
- MCM Boards
- Wireless Communication Circuits
- IR LEDs
- SMART & PCMCIA Cards

MECHANICAL CHARACTERISTICS

- Standard EIA Chip Size: 0402
- Approximate Weight: 0.73 milligrams
- Lead-Free Plating
- Solder Reflow Temperature:
 - Lead-Free - Sn/Ag/Cu, 96/3.5/0.5: 260-270°C
- Flammability Rating UL 94V-0
- 8mm Tape per EIA Standard 481
- Top Contacts: Solder Bump 0.004" in Height (Nominal)

CIRCUIT DIAGRAM



1 Line of Protection

TYPICAL DEVICE CHARACTERISTICS
MAXIMUM RATINGS @ 25°C Unless Otherwise Specified

PARAMETER	SYMBOL	VALUE	UNITS
Peak Pulse Power (tp = 8/20μs) - See Figure 1	P _{PP}	250	Watts
Operating Temperature	T _A	-55 to 150	°C
Storage Temperature	T _{STG}	-55 to 150	°C

ELECTRICAL CHARACTERISTICS PER LINE @ 25°C Unless Otherwise Specified

PART NUMBER (Note 1)	RATED STAND-OFF VOLTAGE V _{WM} VOLTS	MINIMUM BREAKDOWN VOLTAGE @ 1mA V _(BR) VOLTS	MAXIMUM CLAMPING VOLTAGE (Fig. 2) @ I _p = 1A V _c VOLTS	MAXIMUM CLAMPING VOLTAGE (Fig. 2) @ 8/20μS V _c @ I _{PP}	MAXIMUM LEAKAGE CURRENT (Note 2) @ V _{WM} I _D μA	TYPICAL CAPACITANCE @ 0V, 1MHz C pF
P0402FC3.3C	3.3	4.0	7.0	12.5V @ 20A	75*	150
P0402FC05C	5.0	6.0	11.0	14.7V @ 17A	10**	100
P0402FC08C	8.0	8.5	13.2	19.2V @ 13A	10***	75
P0402FC12C	12.0	13.3	19.8	29.7V @ 9A	1	50
P0402FC15C	15.0	16.7	25.4	35.7V @ 7A	1	40
P0402FC24C	24.0	26.7	37.2	55.0V @ 5A	1	30
P0402FC36C	36.0	40.0	70.0	84.0V @ 3A	1	25

NOTES

- All devices are bidirectional. Electrical characteristics apply in both directions.
- *Maximum leakage current < 5μA @ 2.8V. **Maximum leakage current < 500nA @ 3.3V. ***Maximum leakage current < 200nA @ 5V.

TYPICAL DEVICE CHARACTERISTICS

FIGURE 1
PEAK PULSE POWER VS PULSE TIME

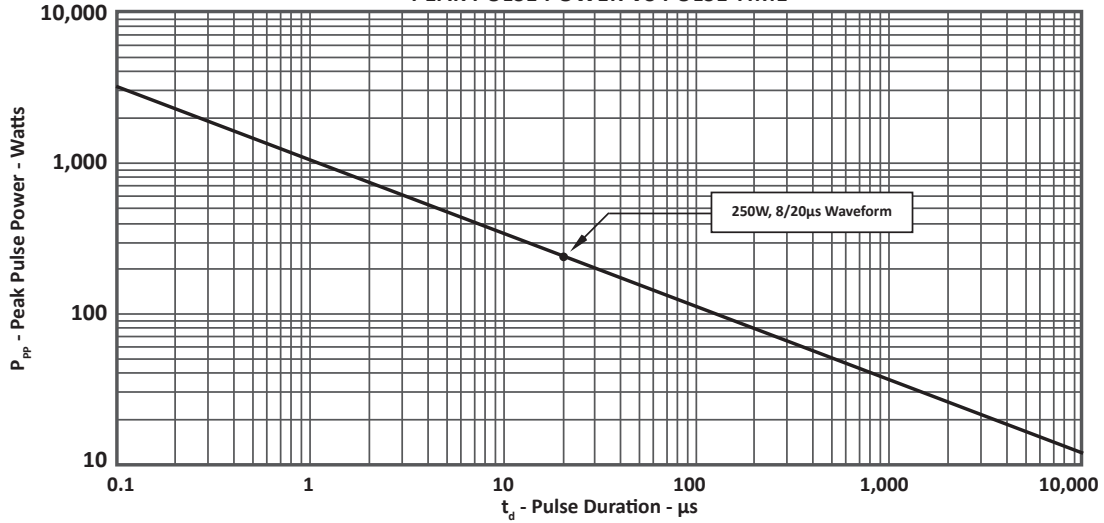

FIGURE 2
PULSE WAVE FORM

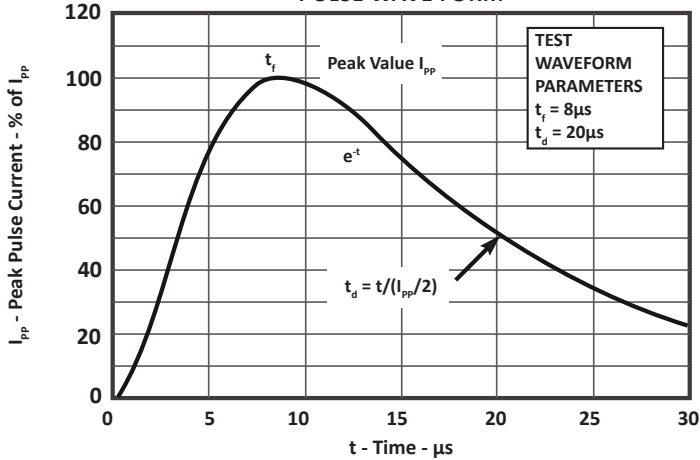
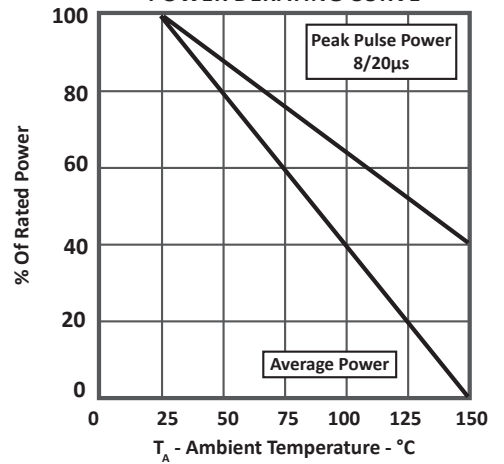
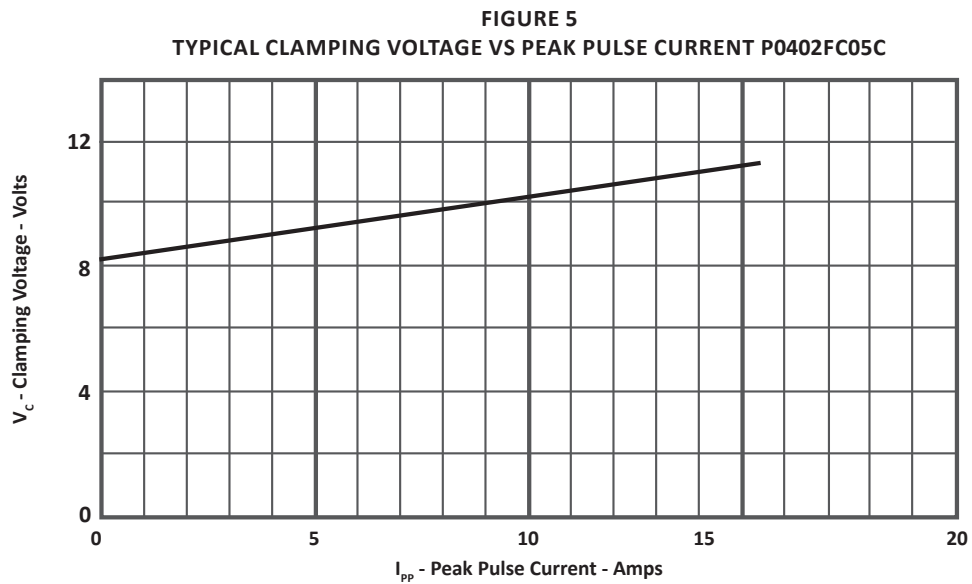
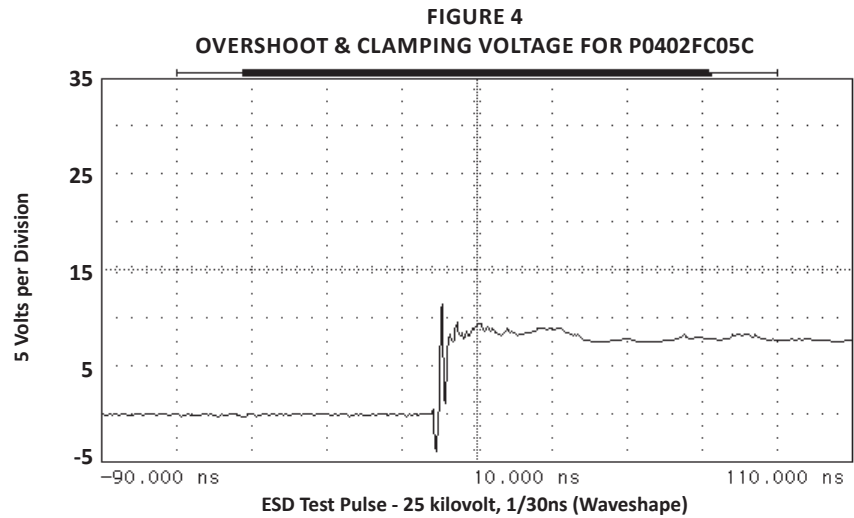

FIGURE 3
POWER DERATING CURVE



TYPICAL DEVICE CHARACTERISTICS



SPICE MODEL

FIGURE 1
SPICE MODEL FOR

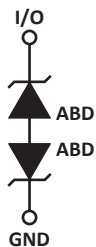

ABD - Avalanche Breakdown Diode (TVS)

TABLE 1 - SPICE PARAMETERS		
PARAMETER	UNIT	ABD(TVS)
BV	V	See Table 2
IBV	μA	1
C_{jo}	pF	See Table 2
I_s	A	See Table 2
Vj	V	0.6
M	-	0.33
N	-	1
R_s	-	See Table 2
TT	s	1E-8
EG	eV	1.11

TABLE 2 - ABD SPECIFIC SPICE PARAMETERS				
PART NUMBER	B_v (VOLTS)	C_{jo} (pF)	I_s (AMPS)	R_s (OHMS)
P0402FC3.3C	4.0	150	1E-11	0.20
P0402FC05C	6.0	100	1E-11	0.16
P0402FC08C	8.5	75	1E-13	0.33
P0402FC12C	13.3	50	1E-13	0.51
P0402FC15C	16.7	40	1E-13	0.53
P0402FC24C	26.7	20	1E-13	0.63
P0402FC36C	40.2	15	1E-13	0.73

SOLDER REFLOW INFORMATION

PRINTED CIRCUIT BOARD RECOMMENDATIONS	
PARAMETER	VALUE
Pad Size on PCB	0.275mm
Pad Shape	Round
Pad Definition	Non-Solder Mask Defined Pads
Solder Mask Opening	0.325mm Round
Solder Stencil Thickness	0.150mm
Solder Stencil Aperture Opening (Laser cut, 5% tapered walls)	0.330mm Round
Solder Paste Type	No Clean
Pad Protective Finish	OSP (Entek Cu Plus 106A)
Tolerance - Edge To Corner Ball	±50µm
Solder Ball Side Coplanarity	±20µm
Maximum Dwell Time Above Liquidous (183°C)	60 seconds
Soldering Maximum Temperature	270°C

REQUIREMENTS

Temperature:

T_p for Lead-Free (Sn/Ag/Cu): 260-270°C

T_p for Tin-Lead: 240-245°C

Preheat time and temperature depends on solder paste and flux activation temperature, component size, weight, surface area and plating.

RECOMMENDED NON-SOLDER MASK DEFINED PAD ILLUSTRATION

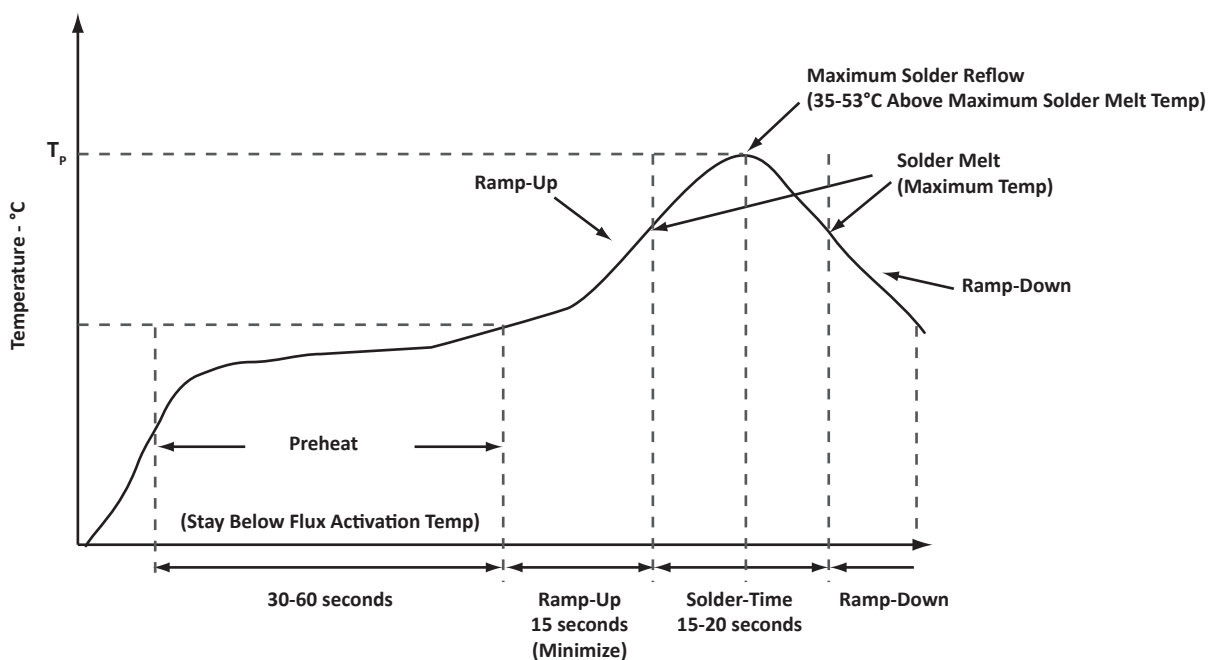
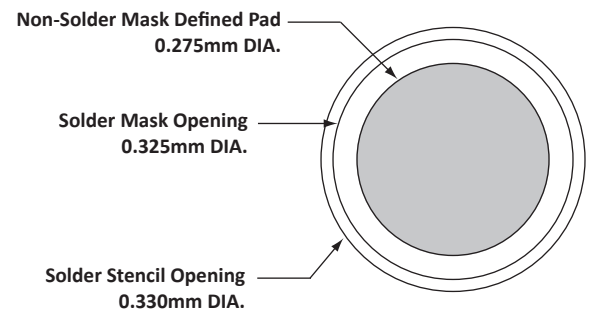

0402 PACKAGE INFORMATION

OUTLINE DIMENSIONS

DIM	MILLIMETERS		INCHES	
	MIN	MAX	MIN	MAX
A	0.46		0.018	
B	0.86		0.034	
C	0.98	1.02	0.038	0.040
D	0.10		0.004	
E	0.35		0.014	
F	0.458	0.508	0.018	0.020
G	0.20		0.008	
H	0.076	0.127	0.003	0.005
I	0.406		0.016	

NOTES

- Controlling dimensions in inches.
- Decimal tolerance: .xxx ± 0.05mm (0.002").
- Maximum chip size: 1.02mm (0.040") by 0.51mm (0.020").

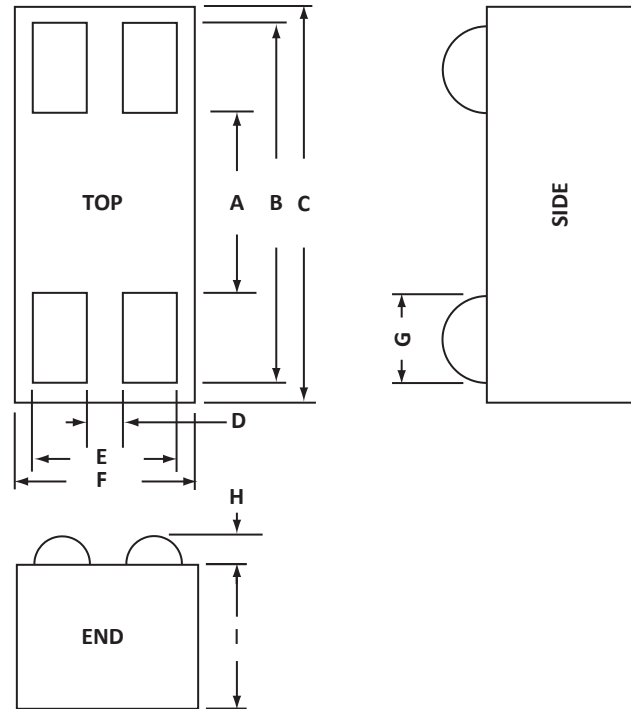

LAYOUT DIMENSIONS

DIM	MILLIMETERS	INCHES
	NOMINAL	NOMINAL
A	0.23	0.009
B	0.48	0.019
C	0.69	0.027
D	0.46	0.018
E	0.99	0.039
F	0.20	0.008
G	0.20	0.008
H	0.66	0.026
I	0.13	0.005

NOTES

- Controlling dimensions in inches.
- Decimal tolerance: .xxx ± 0.05mm (0.002").

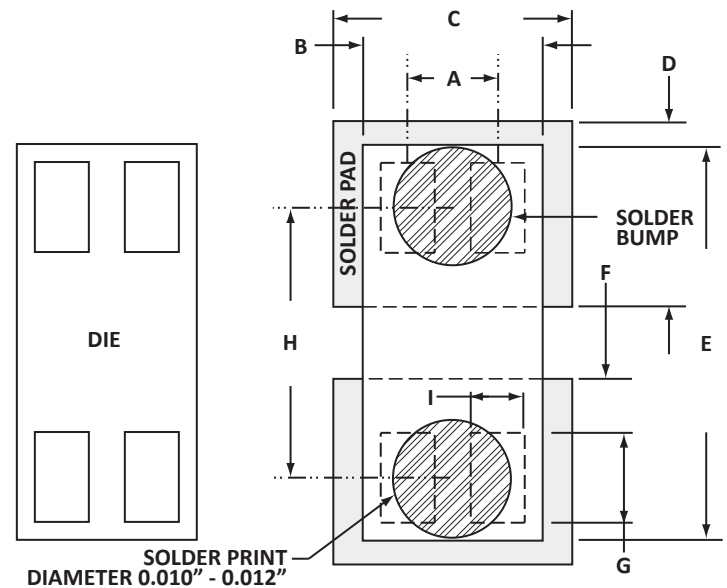

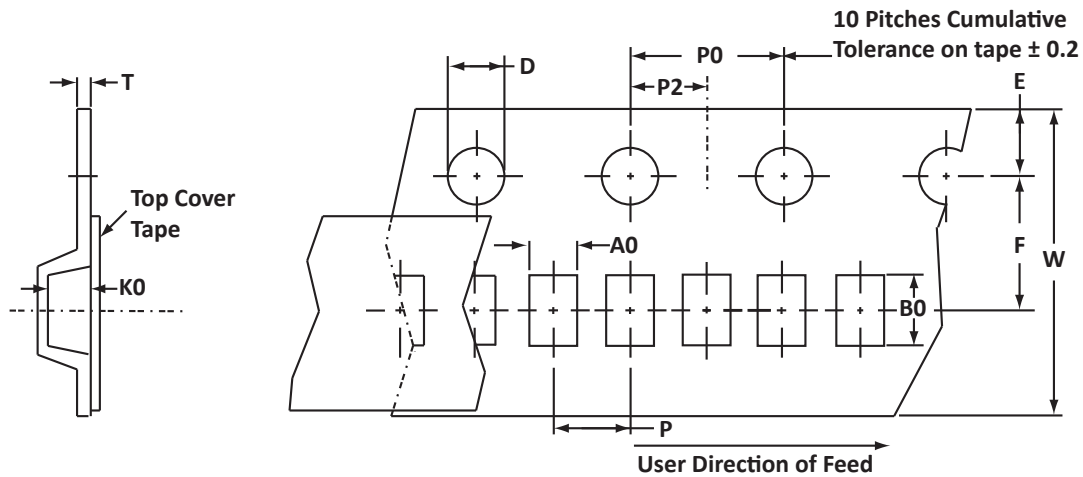
TAPE AND REEL INFORMATION

SPECIFICATIONS

REEL DIA.	TAPE WIDTH	A0	B0	K0	D	E	F	W	P0	P2	P	Tmax
178(7")	8	0.70 ± 0.05	1.15 ± 0.10	0.56 ± 0.05	1.55 ± 0.05	1.75 ± 0.10	3.50 ± 0.05	8.00 ± 0.20	4.00 ± 0.05	2.00 ± 0.05	2.00 ± 0.05	0.25

NOTES

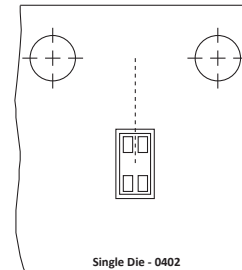
- Dimensions in millimeters.
- Top view of tape. Metal contacts are face down in tape package.
- Orientation: preferred stencil - 0.1mm (0.004").
- Surface mount product is taped and reeled in accordance with EIA 481.
- 8mm plastic tape: 7" Reels - 5,000 (pocket under hole skipped) or 10,000 pieces per reel.
- Marking on Reel - part number, date code and lot number.

TAPE & REEL ORIENTATION

Package outline, pad layout and tape specifications per document number 06001.R5 8/10.

ORDERING INFORMATION

BASE PART NUMBER (xx = Voltage)	LEADFREE SUFFIX	TAPE SUFFIX	QTY/REEL	REEL SIZE	TUBE QTY
P0402FCxxC	-LF	-T75-1	5,000	7"	n/a
P0402FCxxC	-LF	-T710-1	10,000	7"	n/a

COMPANY INFORMATION

COMPANY PROFILE

ProTek Devices, based in Tempe, Arizona USA, is a manufacturer of Transient Voltage Suppression (TVS) products designed specifically for the protection of electronic systems from the effects of lightning, Electrostatic Discharge (ESD), Nuclear Electromagnetic Pulse (NEMP), inductive switching and EMI/RFI. With over 25 years of engineering and manufacturing experience, ProTek designs TVS devices that provide application specific protection solutions for all electronic equipment/systems.

ProTek Devices Analog Products Division, also manufactures analog interface, control, RF and power management products.

CONTACT US

Corporate Headquarters

2929 South Fair Lane
Tempe, Arizona 85282
USA

By Telephone

General: 602-431-8101
Sales: 602-414-5109
Customer Service: 602-414-5114

By Fax

General: 602-431-2288

By E-mail:

Sales: sales@protekdevices.com
Customer Service: service@protekdevices.com
Technical Support: support@protekdevices.com

Web

www.protekdevices.com
www.protekanalog.com

COPYRIGHT © ProTek Devices 2000 - This literature is subject to all applicable copyright laws and is not for resale in any manner.

SPECIFICATIONS: ProTek reserves the right to change the electrical and or mechanical characteristics described herein without notice.

DESIGN CHANGES: ProTek reserves the right to discontinue product lines without notice and that the final judgement concerning selection and specifications is the buyer's and that in furnishing engineering and technical assistance. ProTek assumes no responsibility with respect to the selection or specifications of such products. ProTek makes no warranty, representation or guarantee regarding the suitability of its products for any particular purpose, nor does ProTek assume any liability arising out of the application or use of any product or circuit and specifically disclaims any and all liability without limitation special, consequential or incidental damages.

LIFE SUPPORT POLICY: ProTek Devices products are not authorized for use in life support systems without written consent from the factory.

PATENT INFORMATION: This device is patented under U.S. Patent No. Des. "D456,367S".