

PTH 32003

25 Watts, 1.9–2.0 GHz

50-Ohm High-Gain Power Hybrid

Description

The PTH 32003 is a high-gain 50-ohm power hybrid intended for applications requiring linear amplification and high gain in the PCS frequency range. The part is designed to operate with 50-ohm source and load impedances and includes bias circuitry with temperature compensation. This device may be used as a high-gain driver or as a final output device. The PTH 32003 simplifies system design and saves space with an overall footprint of 1.21 square inch.

- Performance at 1.930 to 1.990 GHz,
 $V_{\text{SUPPLY}} = 26 \text{ V}$, $V_{\text{BIAS}(1)} = 8.0 \text{ V}$, $V_{\text{BIAS}(2)} = 8.0 \text{ V}$
 - Power Gain = +24 dB Nom.
 - Output Power = 25 Watts (P-1dB) Min
 - Small Signal Flatness = $\pm 0.2 \text{ dB}$ Min
- Higher gain available with increased bias voltages
- Optimum performance guaranteed with bias voltages at 8.0 Volts
- Exceptional phase linearity and delay characteristics

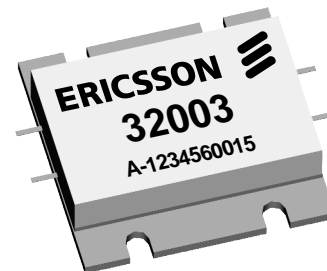
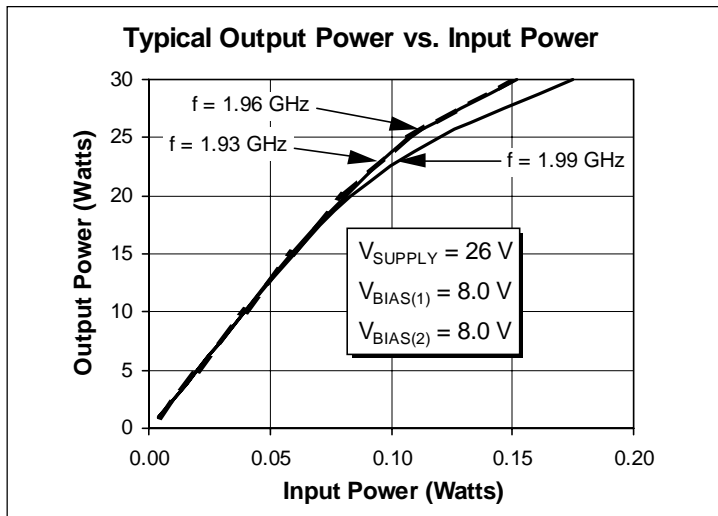

Package J

Performance Characteristics

Parameter	Symbol	Min	Typ	Max	Units
Frequency Range	f	1930	—	1990	MHz
Output Power at 1 dB Compressed $V_{\text{DS}} (\text{Nom.}) = 26 \text{ V}$, $V_{\text{BIAS}(1)} = 8.0 \text{ V}$, $V_{\text{BIAS}(2)} = 8.0 \text{ V}$	P-1dB	25	30	—	W
Input VSWR $V_{\text{DS}} (\text{Nom.}) = 26 \text{ V}$, $V_{\text{BIAS}(1)} = 8.0 \text{ V}$, $V_{\text{BIAS}(2)} = 8.0 \text{ V}$	ψ	—	1.2:1	1.5:1	—
Small Signal Gain $V_{\text{DS}} (\text{Nom.}) = 26 \text{ V}$, $V_{\text{BIAS}(1)} = 8.0 \text{ V}$, $V_{\text{BIAS}(2)} = 8.0 \text{ V}$, $I_{\text{DQ}(1)} = 270 \text{ mA}$, $I_{\text{DQ}(2)} = 360 \text{ mA}$	P_g	+23	+24	—	dB
Gain Flatness $V_{\text{DS}} (\text{Nom.}) = 26 \text{ V}$, $V_{\text{BIAS}(1)} = 8.0 \text{ V}$, $V_{\text{BIAS}(2)} = 8.0 \text{ V}$	—	± 0.2	± 0.15	—	dB

Typical Performance

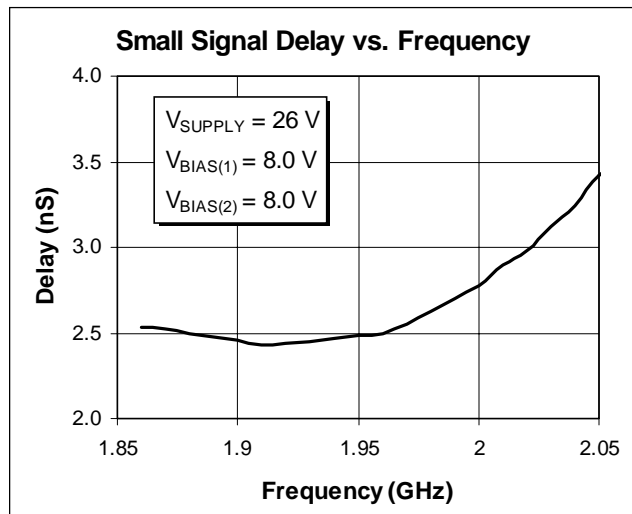
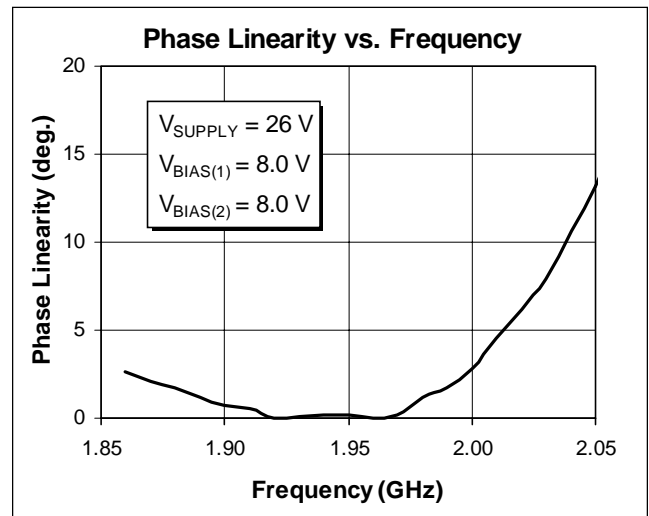
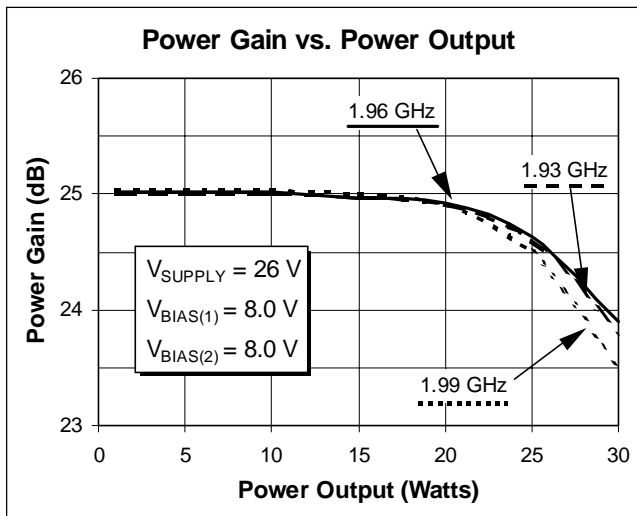
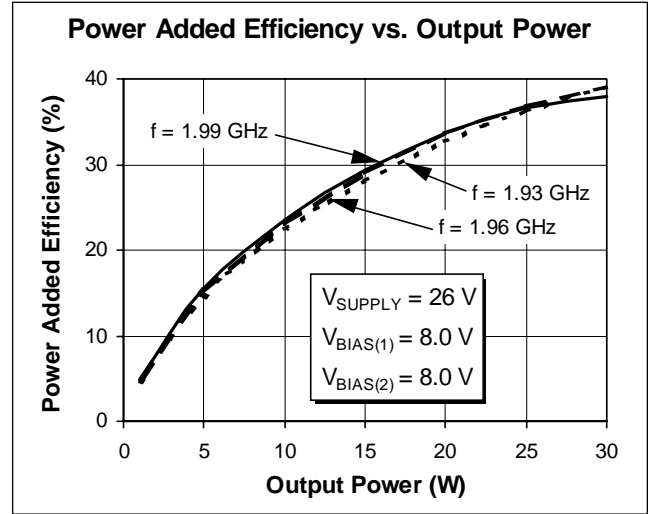
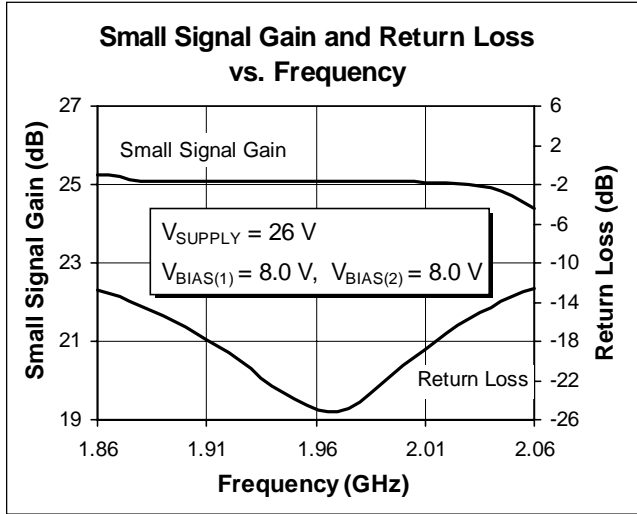

Typical Performance (cont.)

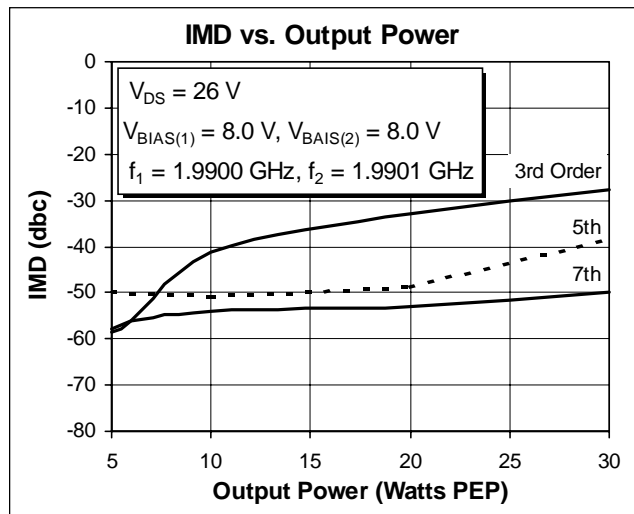
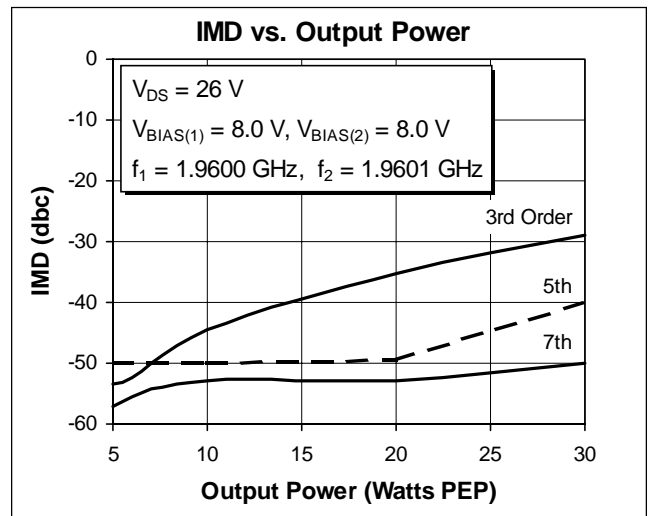
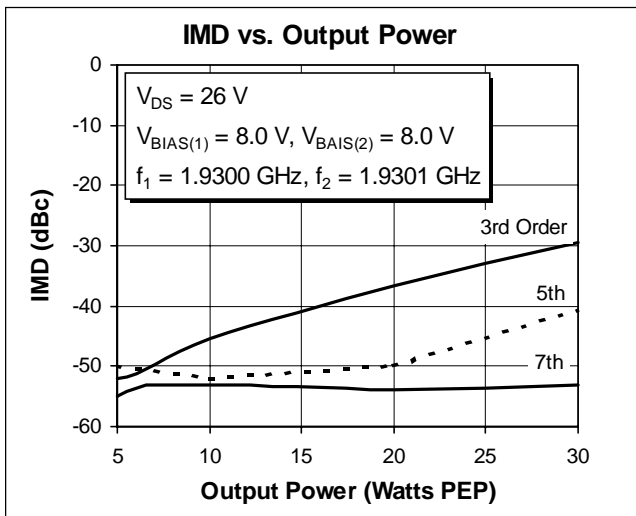
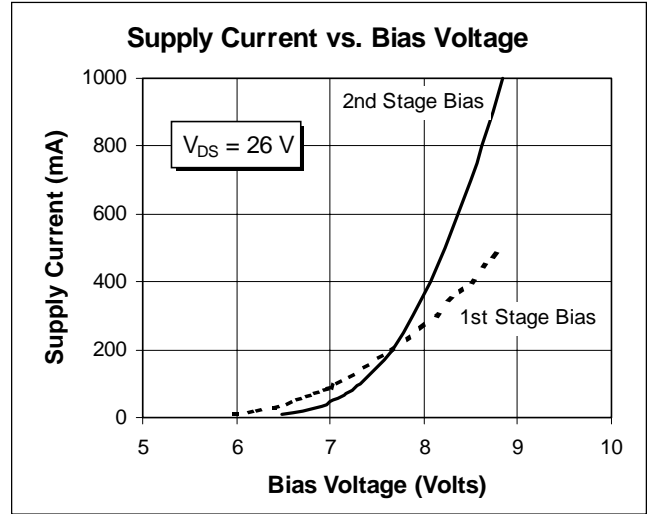
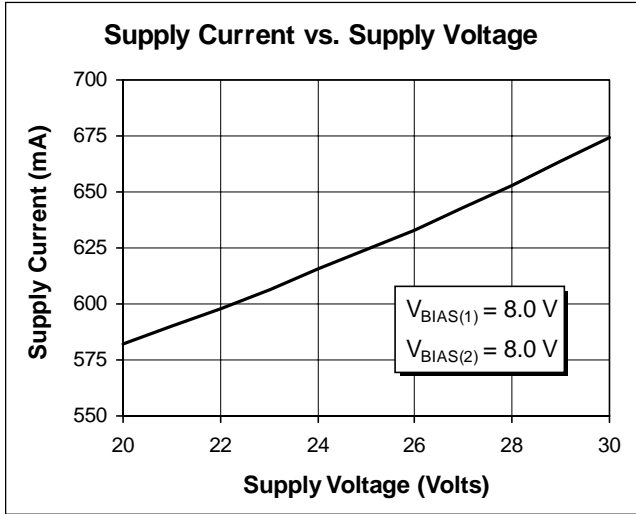

Pin Out Schematic

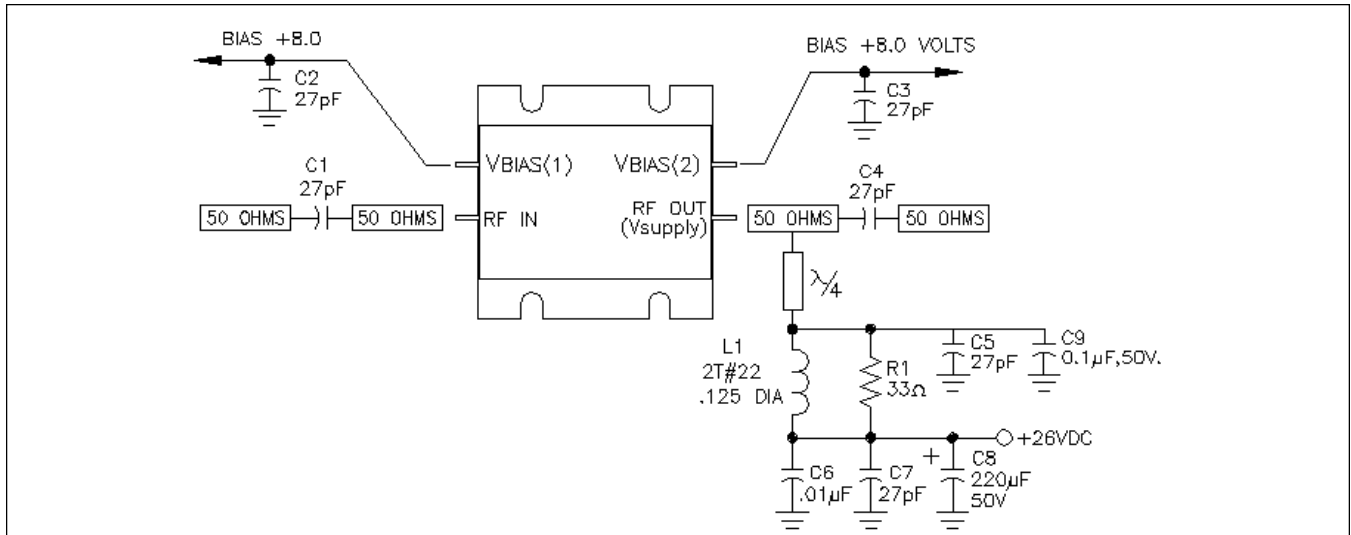

Package Mechanical Specifications

