

# RECTIFIERS

Military Approved, High Efficiency,  
2.5 Amp and 6.0 Amp

1N5802, 1N5804, 1N5806,  
1N5807, 1N5809, 1N5811  
JAN, JANTX & JANTXV

## FEATURES

- Qualified to MIL-S-19500/477
- PIV: to 150V
- Low Forward Voltage

## DESCRIPTION

This series of high efficiency power rectifiers are particularly applicable to switching regulator power supplies where extremely fast switching and low forward losses are most important.

## ABSOLUTE MAXIMUM RATINGS

Peak Inverse Voltage	2.5A Series	6A Series
50V	JAN, JANTX & JANTXV 1N5802	JAN, JANTX & JANTXV 1N5807
100V	JAN, JANTX & JANTXV 1N5804	JAN, JANTX & JANTXV 1N5809
150V	JAN, JANTX & JANTXV 1N5806	JAN, JANTX & JANTXV 1N5811

	2.5A SERIES	6A SERIES
Maximum Average D.C. Output Current		
@ $T_L = 75^\circ\text{C}$ , $L = 3/8"$	2.5A	6.0A
@ $T_A = 55^\circ\text{C}$	1.0A	3.0A
Non-Repetitive Sinusoidal		
Surge Current (8.3ms)	35A	125A
Operating Temperature Range	-65°C to +175°C	
Storage Temperature Range	-65°C to +200°C	
Thermal Resistance, $\theta_{JL}$ @ $L = 3/8"$	59°C/W	35.5°C/W

See lead temperature derating curve

## MECHANICAL SPECIFICATIONS

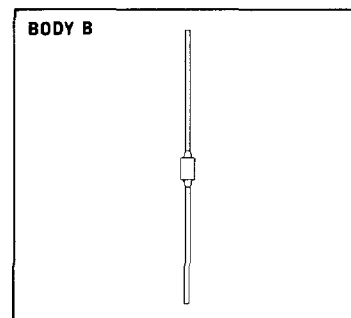
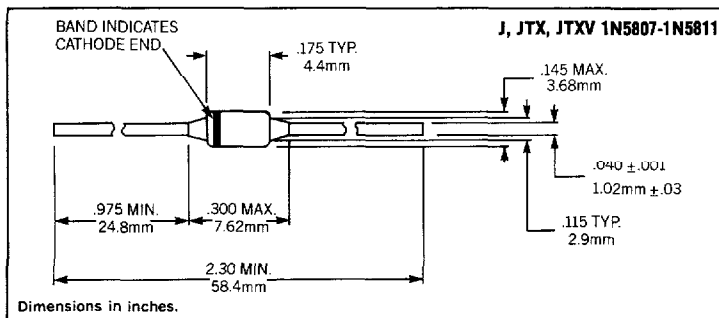
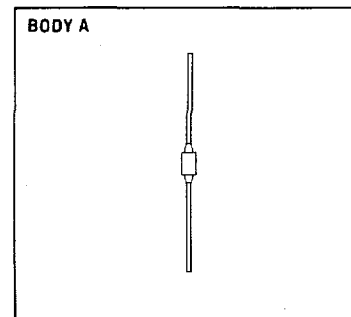
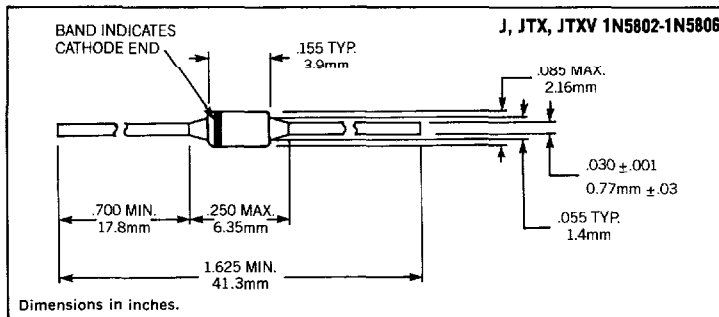

THESE DEVICES ALSO AVAILABLE IN SURFACE MOUNT PACKAGE. SEE SECTION 10

ELECTRICAL SPECIFICATIONS (at 25°C unless noted)

2

Type	PIV	Minimum Breakdown Voltage @ 100µA	Forward Voltage		Maximum Reverse Current @ PIV		Maximum Reverse Recovery Time
			@ 25°C	@ 100°C	25°C	100°C	
J, JTX, JTXV 1N5807	50V	60V	.875V Max. @ 4A (pk)	.8V Max. @ 4A (pk)	5µA	150µA	30ns $I_F = I_R = 1.0A$ $I_{REC} = 0.1A$ $di/dt = 100A/\mu s$ min.
J, JTX, JTXV 1N5809	100V	110V	.925V Max. @ 6A (pk)				
J, JTX, JTXV 1N5811	150V	160V					
J, JTX, JTXV 1N5802	50V	60V	.875V Max. @ 1A (pk)	.8V Max. @ 1A (pk)	1µA	50µA	25ns $I_F = I_R = 0.5A$ $I_{REC} = 0.05A$ $di/dt = 65A/\mu s$ min.
J, JTX, JTXV 1N5804	100V	110V	.975V Max. @ 2.5A (pk)				
J, JTX, JTXV 1N5806	150V	160V					

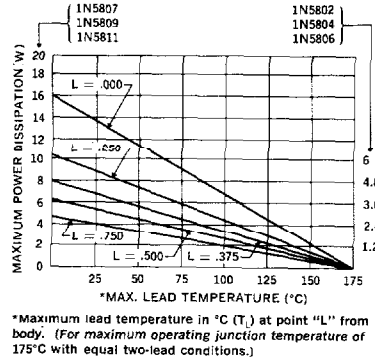
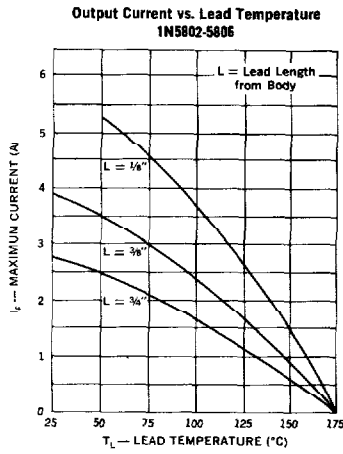
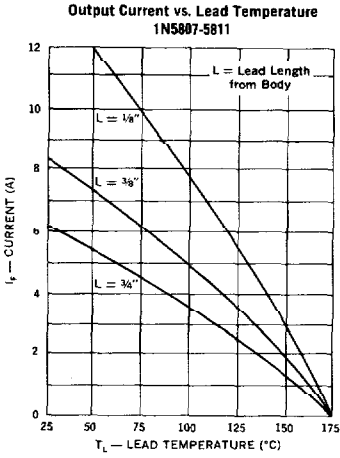

\*Maximum lead temperature in °C (T<sub>L</sub>) at point "L" from body. (For maximum operating junction temperature of 175°C with equal two-lead conditions.)

Reverse-Recovery Circuit

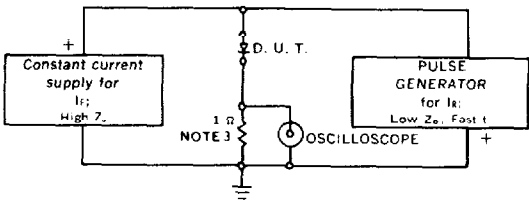

- NOTES:
- Oscilloscope: Rise time  $\leq 3ns$ ; input impedance = 50Ω.
  - Pulse Generator: Rise time  $\leq 8ns$ ; source impedance 10Ω.
  - Current viewing resistor, non-inductive, coaxial recommended.

Characteristic Waveform

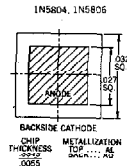
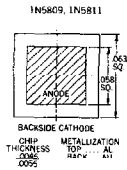
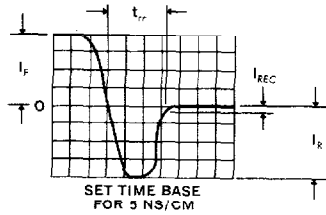

Typical Forward Current vs. Forward Voltage  
JAN & JANTX 1N5807-5811

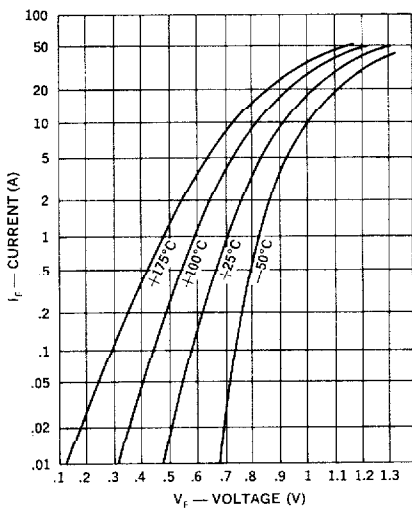

Typical Reverse Current vs. Voltage  
JAN & JANTX 1N5807-5811

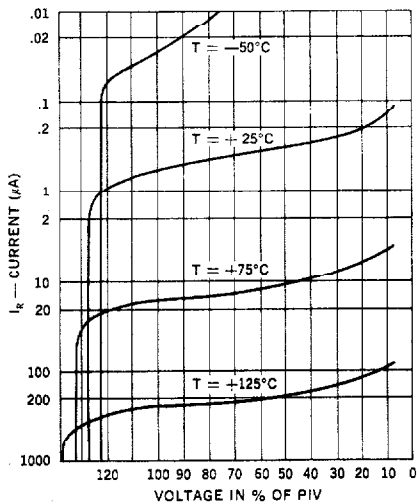

Typical Forward Current vs. Forward Voltage  
JAN & JANTX 1N5802-5806

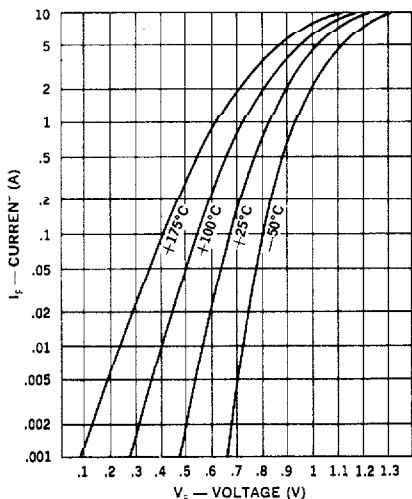

Typical Reverse Current vs. Voltage  
JAN & JANTX 1N5802-5806

