

BL - 23G

The BL - 23G is a GaAlAsLED mounted in a clear sidelooking package. The device is ideal for the use with plastic fiber optic cables, as a light loss is minimum at wavelength of 660nm.

FEATURES

- Small size
- Low profile package
- High speed response
- Sidelooking plastic package

APPLICATIONS

- Fiber optic communication

DIMENSIONS

(Unit : mm)

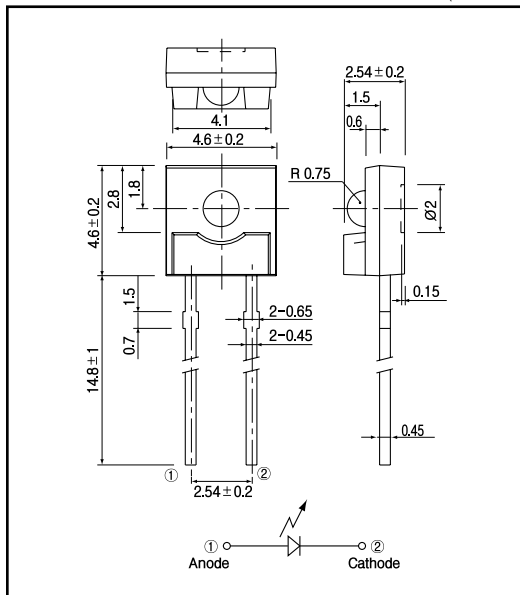

MAXIMUM RATINGS

(Ta=25)

Item	Symbol	Rating	Unit
Reverse voltage	V _R	5	V
Forward current	I _F	40	mA
Pulse forward current *1	I _{FP}	0.3	A
Power dissipation	P ₀	100	mW
Operating temp.	Topr.	- 25 ~ +85	
Storage temp.	Tstg.	- 30 ~ +100	
Soldering temp. *2	Tsol.	240	

*1. pulse width : tw 100 ꝑec.period : T=10msec.

*2. For MAX.5 seconds at the position of 2 mm from the package

ELECTRO-OPTICAL CHARACTERISTICS

(Ta=25)

Item	Symbol	Conditions	Min.	Typ.	Max.	Unit.
Forward voltage	V _F	I _F =20mA		1.8	2.2	V
Reverse current	I _R	V _R =5V			10	µA
Capacitance	C _t	f=1MHz		47		pF
Radiant intensity	P ₀	I _F =20mA		0.6		mW/sr
Peak emission wavelength	ꝑ	I _F =20mA		660		nm
Spectral bandwidth 50%		I _F =20mA		20		nm
Half angle				± 30		deg.

Emitter for Optical Fiber(GaAlAs)

BL - 23G

Power dissipation Vs. Ambient temperature

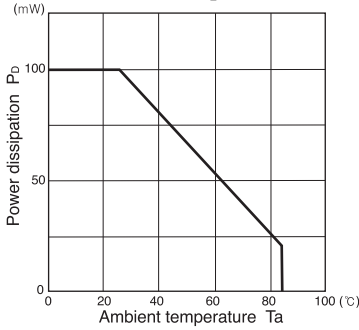

Radiant intensity Vs. Forward current

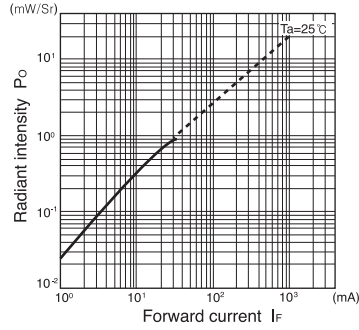

Relative radiant intensity Vs. Ambient temperature

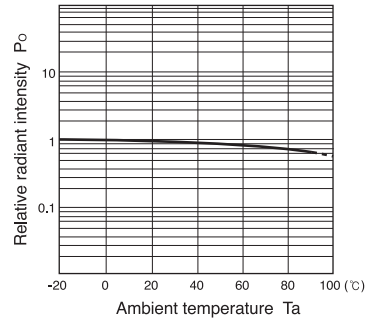

Relative intensity Vs. Wavelength

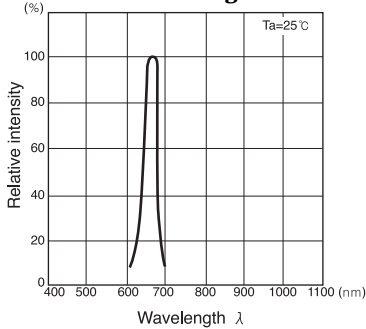

Forward current Vs. Forward voltage

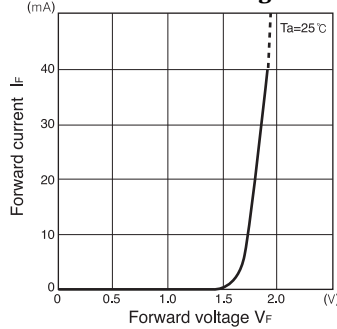

Radiant Pattern

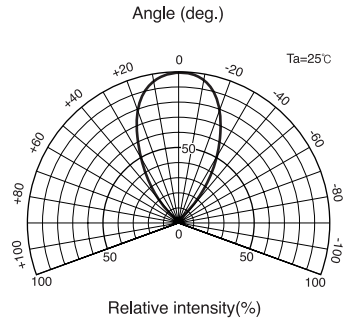

Relative radiant intensity Vs. Distance

