



SL Series Toroidal Power Inductors

Features

- Operating frequency to 1 MHz
- High energy storage with minimum saturation
- High stability from no load to full load
- Available in both SMD and TH versions
- Manufactured in ISO-9001:2000, TS-16949:2002 and ISO-14001:2004 certified Talema facility
- Meets lead free reflow level J-STD-020C
- Fully RoHS compliant



Electrical Specifications @ 25°C

Test voltage between windings: 500 Vrms

Operating temperature range: -40°C to +130°C

Climatic Category: IEC68-1 40/125/56

Test frequency: Inductance measured @ 10kHz / 10mV

Part Number	Rated Current (I _{DC})	L _N (μH) @ I rated ±20%	L _O (μH) No Load ±20%	DCR (mOhms) Nominal	Energy Storage (μJ)	Package	
						"SMD"	"THT"
SL__-3.4-1.1	3.4	1.1	1.2	9.6	6	S1	T1
SL__-1.4-6.4	1.4	6.4	7.0	62.0	6	S1	T1
SL__-1.0-17.6	1.0	17.6	20.3	117.7	9	S1	T1
SL__-4.8-4.0	4.8	4.0	4.5	17.0	44	S2	T2
SL__-2.8-9.6	2.8	9.6	11.0	41.1	37	S2	T2
SL__-1.4-29.7	1.4	29.7	33.6	144.3	29	S2	T2
SL__-0.94-114	0.94	114	131.7	411.2	50	S2	T2
SL__-8.0-2.4	8.0	2.4	3.1	7.8	80	S3	T3
SL__-5.4-5.1	5.4	5.1	6.3	17.5	74	S3	T3
SL__-2.7-16.8	2.7	16.8	19.2	68.5	59	S3	T3
SL__-1.3-58.8	1.3	58.8	65.7	288.8	49	S3	T3
SL__-0.9-192	0.9	192	225.2	534.7	78	S3	T3
SL__-0.72-384	0.72	384	461	765.0	99	S3	T3
SL__-7.8-5.1	7.8	5.1	5.8	10.9	149	S4	T4
SL__-5.5-8.6	5.5	8.6	10.4	26.1	136	S4	T4
SL__-2.7-29	2.7	29	34.8	93.8	106	S4	T4
SL__-0.74-645	0.74	645	771.3	1267.2	177	S4	T4
SL__-14.3-0.84	14.3	0.84	1.2	2.3	83	SH3	--
SL__-11.5-1.32	11.5	1.32	1.7	3.2	87	SH3	--
SL__-13.9-1.7	13.9	1.7	2.2	3.3	162	SH4	--
SL__-11.4-2.5	11.4	2.5	3.0	4.9	162	SH4	--
SL__-7.2-9.7	7.2	9.7	11.8	15.1	241	S5	T5
SL__-5.1-16.1	5.1	16.1	19.1	27.3	209	S5	T5
SL__-2.6-50	2.6	50	56.9	117.2	169	S5	T5
SL__-0.71-1070	0.71	1070	1295	1616.1	270	S5	T5
SL__-12.4-3.6	12.4	3.6	4.5	5.9	269	SH5	--
SL__-10.4-4.9	10.4	4.9	6.3	7.1	254	SH5	--
SL__-15.4-5.4	15.4	5.4	7.0	5.5	617	SH6A	TH6A
SL__-10.9-9.6	10.9	9.6	12.2	11.3	558	SH6A	TH6A
Coupled Inductors							
SLC__-1.1-43.8	1.1	43.8	49.2	280.7	26	SC3	TC3
SLC__-2.7-23.5	2.7	23.5	26.0	81.0	80	SC4	--
SLC__-6.4-4.6	6.4	4.6	4.5	19.0	82	SC5	TC5
SLC__-23.8-0.56	23.8	0.56	0.6	1.2	150	SHC4	--
SLC__-21-1.0	21.0	1.0	1.8	2.1	243	SHC5	--
SLC__-22.4-2.0	22.4	2.0	2.8	3.1	527	SHC6	THC6

Note: The inductance values listed above are based on a 55°C temperature rise and 25°C ambient temperature.

Mounting Styles • SL Series Toroidal Power Inductors

Type S1 - S5

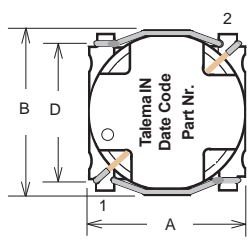

Suggested Pad Layout

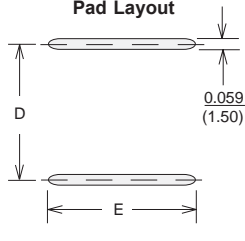

Schematic

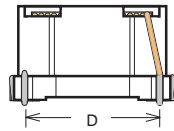
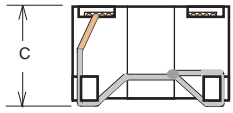

Type T1 - T5

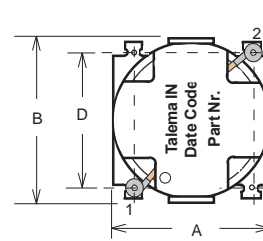

Suggested Board Layout (Top Side View)

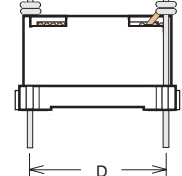
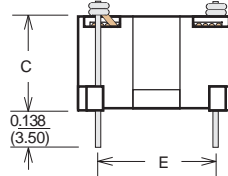
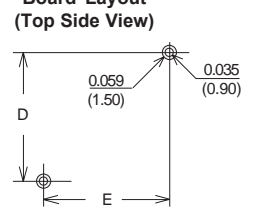

Type SH3 - SH6A

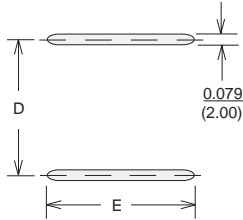
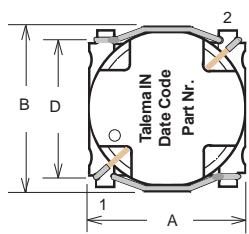

Schematic

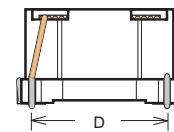
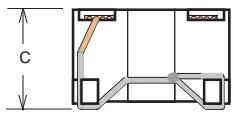

Type TH6A

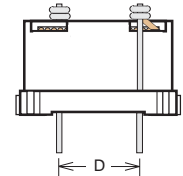
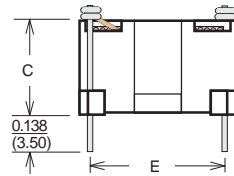
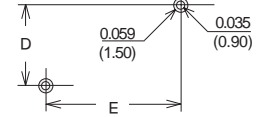
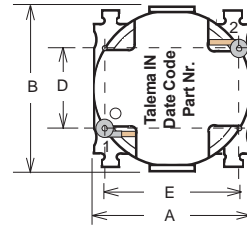

Coupling Transformers

Type SC3 - SC5

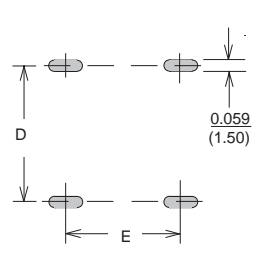
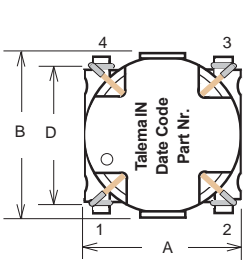

Type SC4

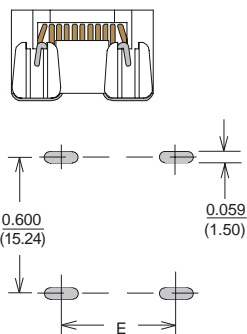
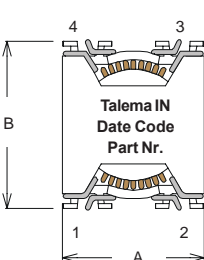

Type TC3 - TC5

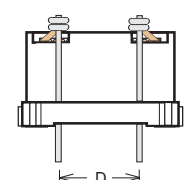
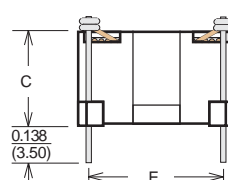
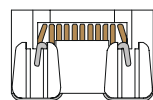
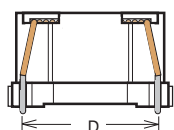
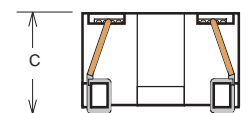
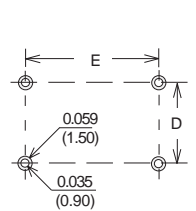
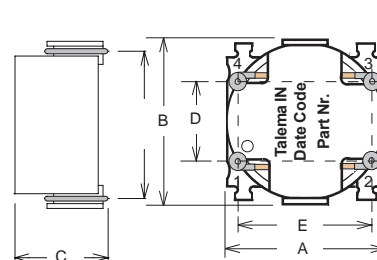

Schematic

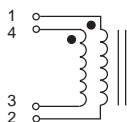



Mounting Styles • SL Series Toroidal Power Inductors

Coupling Transformers

Surface Mount Style

Type SHC4 - SHC6

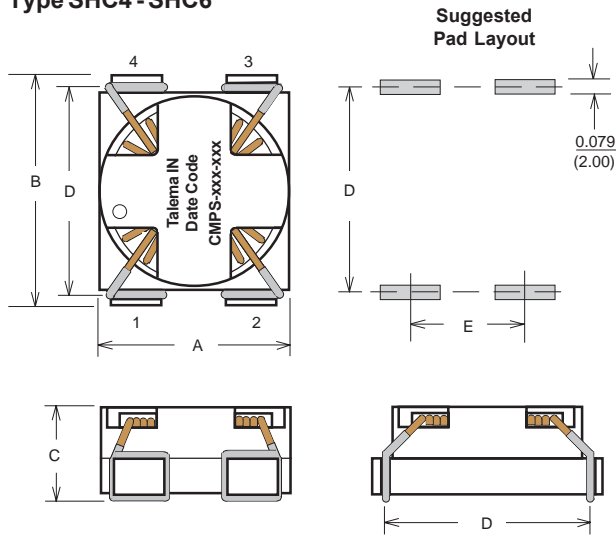

Through Hole Style

THC6

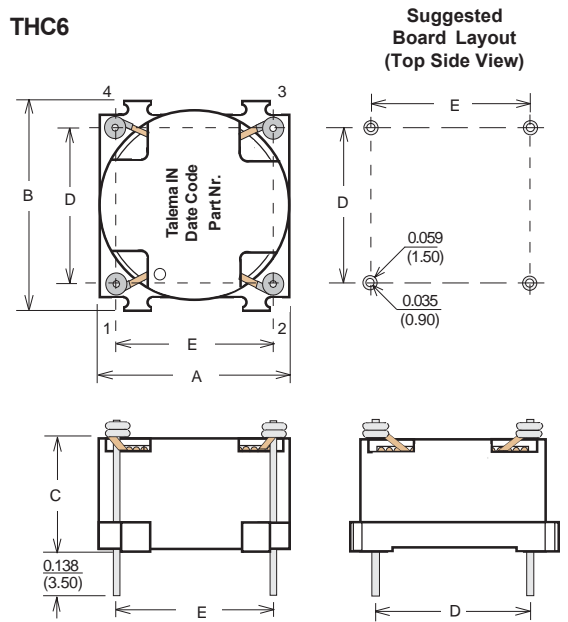

Note: When ordering, add "S" or "T" to the basic part number to denote preferred mounting style. Example: SLS-3.4-1.03 for SMD or SLT-3.4-1.03 for through hole mounting.

Mounting Style	Size Code	Dimensions - Inches ±0.010 (mm ±0.25)					
		A	B	C	D	E	
"S"	S1	0.339 (8.60)	0.339 (8.60)	0.220 (5.60)	0.268 (6.90)	0.354 (9.00)	
	S2	0.433 (11.00)	0.441 (11.20)	0.303 (7.70)	0.358 (9.10)	0.413 (10.50)	
	S3	0.551 (14.00)	0.559 (14.20)	0.343 (8.70)	0.461 (11.70)	0.520 (13.20)	
	S4	0.591 (15.00)	0.614 (15.60)	0.390 (9.90)	0.508 (12.90)	0.551 (14.00)	
	S5	0.669 (17.00)	0.701 (17.80)	0.441 (11.20)	0.591 (15.00)	0.630 (16.00)	
"SH"	SH3	0.620 (15.75)	0.605 (15.37)	0.370 (9.40)	0.500 (12.70)	0.500 (12.70)	
	SH4	0.670 (17.02)	0.670 (17.02)	0.390 (9.90)	0.560 (14.22)	0.490 (12.45)	
	SH5	0.740 (18.80)	0.740 (18.80)	0.390 (9.90)	0.630 (16.00)	0.640 (16.26)	
	SH6A	0.925 (23.50)	0.957 (24.30)	0.445 (11.30)	0.843 (21.40)	0.728 (18.50)	
"SC"	SC3	0.551 (14.00)	0.630 (16.00)	0.343 (8.70)	0.530 (13.46)	0.348 (8.84)	
	SC4	0.590 (14.99)	0.715 (18.16)	0.390 (9.91)	0.600 (15.24)	0.370 (9.40)	
	SC5	0.662 (16.82)	0.760 (19.31)	0.413 (10.50)	0.660 (16.76)	0.445 (11.30)	
"SHC"	SHC4	0.715 (18.16)	0.865 (21.97)	0.390 (9.91)	0.760 (19.30)	0.360 (9.14)	
	SHC5	0.800 (20.32)	0.910 (23.11)	0.390 (9.91)	0.800 (20.32)	0.440 (11.18)	
	SHC6	1.000 (25.40)	1.104 (28.05)	0.409 (10.40)	1.010 (25.65)	0.620 (15.75)	
Mounting Style	Size Code	Dimensions - Inches ±0.010 (mm ±0.25)					Lead Ø
		A	B	C	D	E	
"T"	T1	0.339 (8.60)	0.339 (8.60)	0.201 (5.10)	0.250 (6.35)	0.250 (6.35)	0.020 (0.50)
	T2	0.433 (11.00)	0.441 (11.20)	0.280 (7.10)	0.300 (7.62)	0.300 (7.62)	0.020 (0.50)
	T3	0.551 (14.00)	0.559 (14.20)	0.311 (7.90)	0.375 (9.52)	0.375 (9.52)	0.020 (0.50)
	T4	0.591 (15.00)	0.614 (15.60)	0.358 (9.10)	0.300 (7.62)	0.500 (12.70)	0.022 (0.55)
	T5	0.669 (17.00)	0.701 (17.80)	0.409 (10.40)	0.600 (15.24)	0.500 (12.70)	0.026 (0.65)
"TH"	TH6A	0.925 (23.50)	0.957 (24.30)	0.386 (9.80)	0.650 (16.51)	0.800 (20.32)	0.031 (0.80)
	TC3	0.551 (14.00)	0.630 (16.00)	0.327 (8.30)	0.500 (12.70)	0.400 (10.16)	0.024 (0.60)
"TC"	TC5	0.662 (16.82)	0.760 (19.31)	0.362 (9.20)	0.500 (12.70)	0.500 (12.70)	0.024 (0.60)
	THC6	1.000 (25.40)	1.104 (28.05)	0.357 (9.08)	1.000 (25.40)	0.600 (15.24)	0.028 (0.70)