

FEATURES

- ❑ Rectangular-to-Polar or Polar-to-Rectangular at 50 MHz
- ❑ Performs Direct Digital Synthesis (DDS) functions along with PM and FM Modulation
- ❑ 24-Bit Polar Phase Angle Accuracy
- ❑ Replaces Fairchild TMC2330A
- ❑ 120-pin PQFP

DESCRIPTION

The **L2330** is a coordinate transformer that converts bidirectionally between Rectangular and Polar coordinates.

When in Rectangular-to-Polar mode, the L2330 is able to retrieve phase and magnitude information or backward map from a rectangular raster display to a radial data set.

When in Polar-to-Rectangular mode, the L2330 is able to execute direct digital waveform synthesis and modulation. Real-time image-space conversions are achieved from radially-generated images, such as RADAR, SONAR, and ultrasound to raster display formats.

Functional Description

The L2330 converts bidirectionally between Rectangular (Cartesian) and Polar (Phase and Magnitude) coordinates. The user selects the numeric format. A valid transformed result is

seen at the output after 22 clock cycles and will continue upon every clock cycle thereafter.

When in Rectangular-to-Polar mode, the user inputs a 16-bit Rectangular coordinate and the output generates a Polar transformation with 16-bit magnitude and 16-bit phase. The user may select the data format to be either two's complement or sign-and-magnitude Cartesian data format. Polar Magnitude data is always in magnitude format only. Polar Phase Angle data is modulo 2π so it may be regarded as either unsigned or two's complement format.

When in Polar-to-Rectangular mode, the user inputs 16-bit Polar Magnitude and 32-bit Phase data and the output generates a 16-bit Rectangular coordinate. The user may select the data format to be either two's complement or sign-and-magnitude Cartesian data format.

L2330 BLOCK DIAGRAM

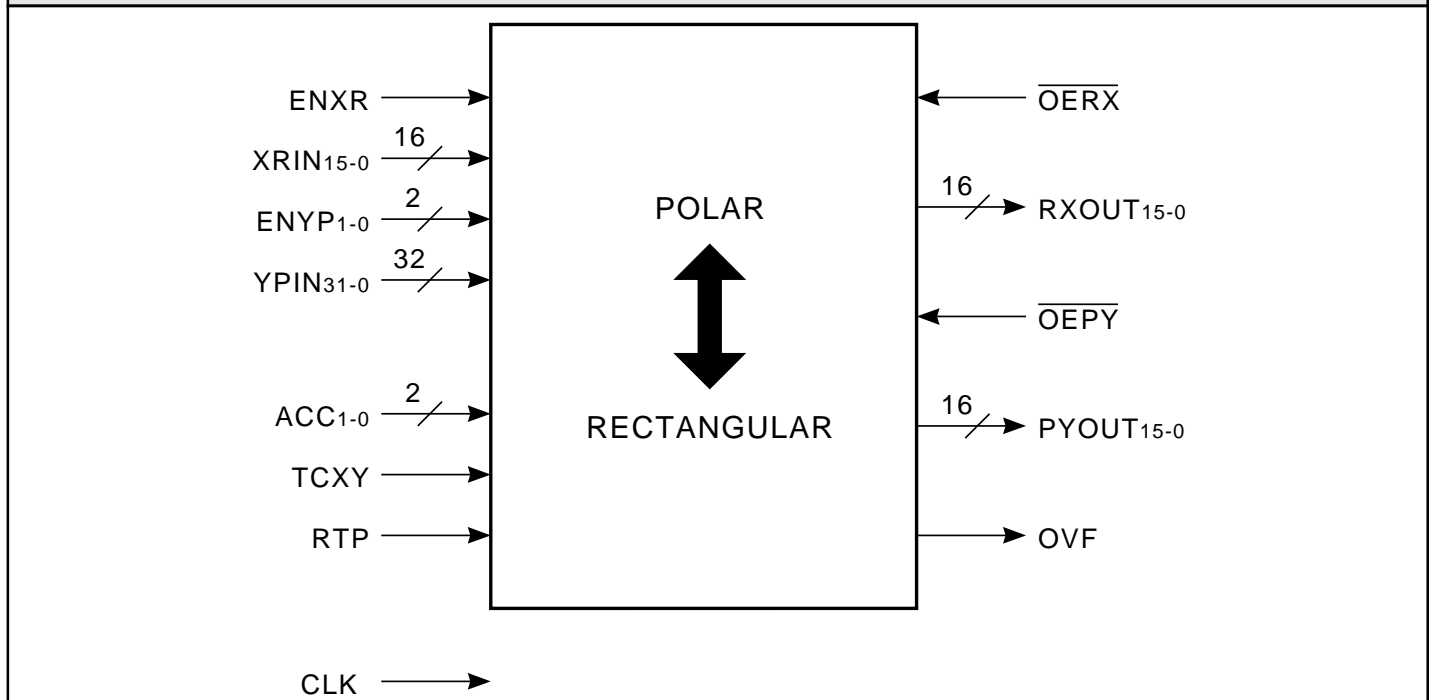

Coordinate Transformer

Outputs

RXOUT15-0 — *x*-coordinate/Magnitude Data Output

RXOUT15-0 is the 16-bit Cartesian *x*-coordinate/Polar Magnitude Data output port. When \overline{OERX} is HIGH, *RXOUT15-0* is forced into the high-impedance state.

PYOUT15-0 — *y*-coordinate/Phase Angle Data Output

PYOUT15-0 is the 16-bit Cartesian *y*-coordinate/Polar Phase Angle Data output port. When \overline{OEPY} is HIGH, *PYOUT15-0* is forced into the high-impedance state.

Controls

ENXR — *x*-coordinate/Magnitude Data Input Enable

When *ENXR* is HIGH, *XRIN* is latched into the input register on the rising edge of clock. When *ENXR* is LOW, the value stored in the register is unchanged.

ENYP1-0 — *y*-coordinate/Phase Angle Data Input Control

ENYP1-0 is the 2-bit *y*-coordinate/Phase Angle Data Input Control that determines four modes as shown in

ENYP1-0	M	C
0 0	Hold	Hold
0 1	Load	Hold
1 0	Hold	Load
1 1	Clear	Load

ACC1-0	Configuration
0 0	No accumulation (normal operation)
0 1	PM accumulator path enabled
1 0	FM accumulator path enabled
1 1	Logical OR of PM and FM (Nonsensical)

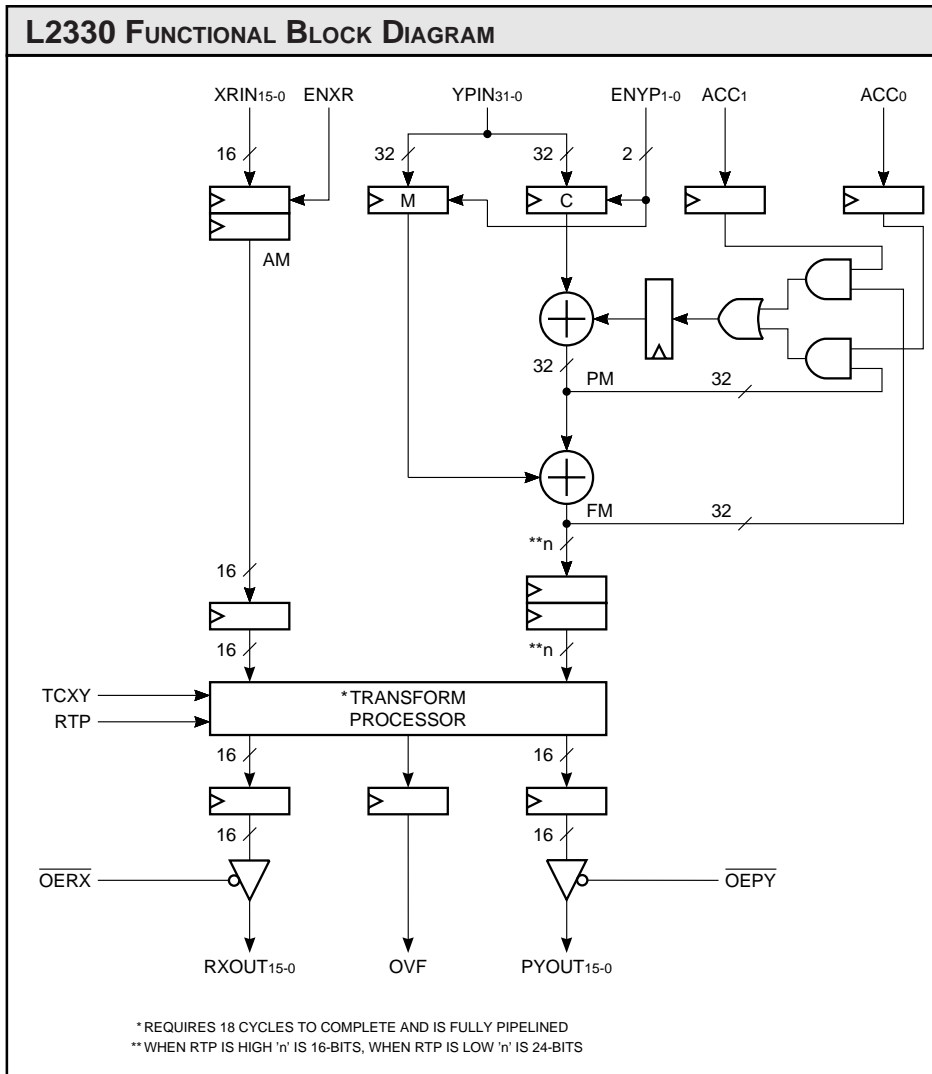

SIGNAL DEFINITIONS

Power

VCC and GND

+5V power supply. All pins must be connected.

Clock

CLK — Master Clock

The rising edge of *CLK* strobes all enabled registers.

Inputs

XRIN15-0 — *x*-coordinate/Magnitude Data Input

XRIN15-0 is the 16-bit Cartesian *x*-coordinate/Polar Magnitude Data input port. *XRIN15-0* is latched on the rising edge of *CLK*.

YPIN31-0 — *y*-coordinate/Phase Angle Data Input

YPIN31-0 is the 32-bit Cartesian *y*-coordinate/Polar Phase Angle Data input port. When *RTP* is HIGH, the input accumulators should not be used. When *ACC* is LOW, the upper 16 bits of *YPIN* are the input port and the lower 16 bits become “don’t cares”. *YPIN31-0* is latched on the rising edge of *CLK*.

Special Arithmetic Functions

Coordinate Transformer

Table 1. 'M' is the Modulation Register and 'C' is the Carrier Register as shown in the Functional Block Diagram.

RTP — Rectangular-to-Polar

When RTP is HIGH, Rectangular-to-Polar conversion mode is selected. When RTP is LOW, Polar-to-Rectangular conversion mode is selected.

ACC1-0 — Accumulator Control

ACC1-0 is the 2-bit accumulator control that determines four modes as shown in Table 2. Changing of the internal phase Accumulator structure is very useful when RTP is LOW allowing for waveform synthesis and modulation. ACC1-0 set to '00' is most commonly used when RTP is HIGH

unless performing backward mapping from Cartesian to Polar coordinates.

TCXY — Data Input/Output Format Select

When TCXY is HIGH, two's complement format is selected. When TCXY is LOW, sign-and-magnitude format is selected.

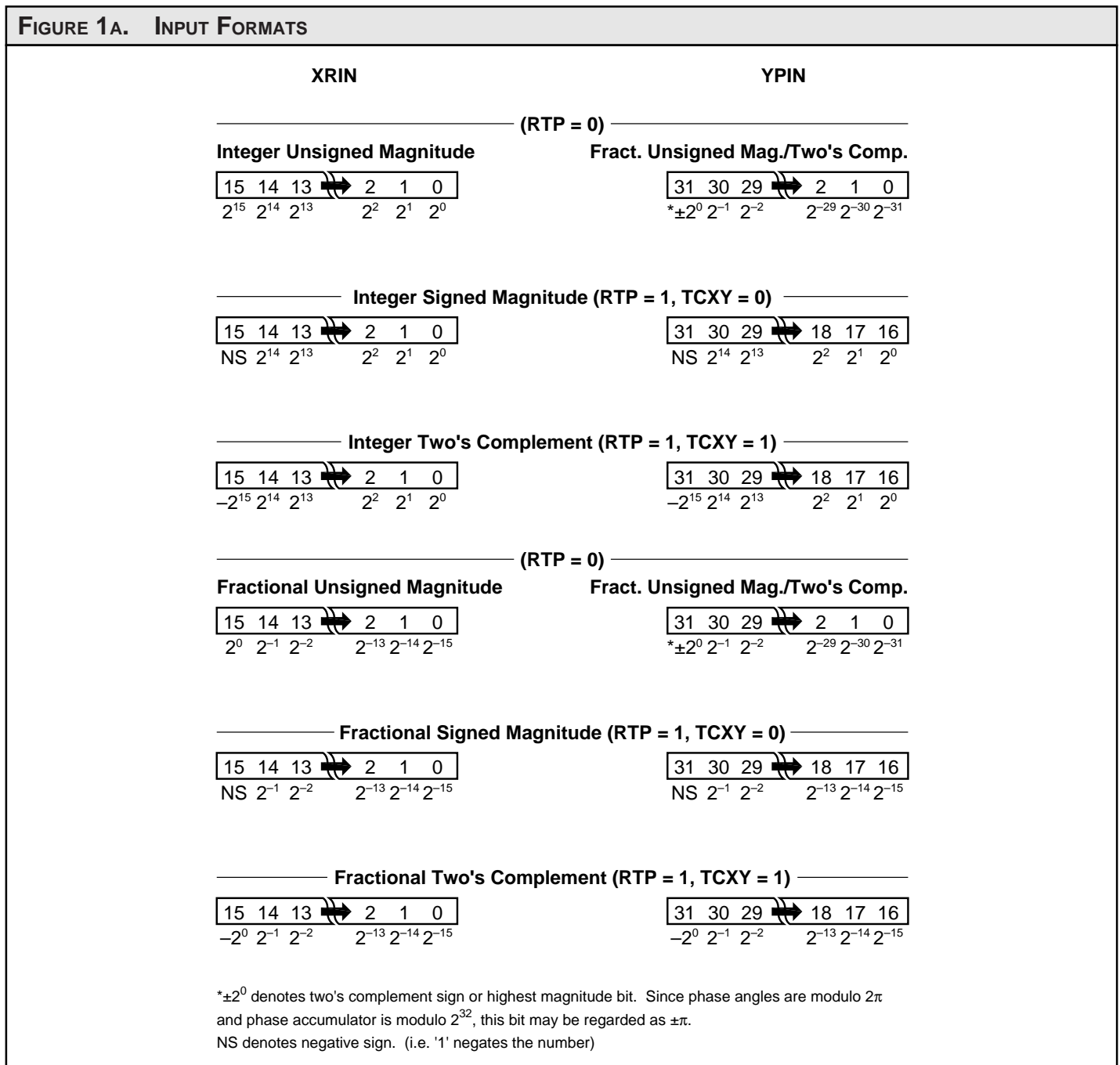

Coordinate Transformer

OVF — Overflow Flag

OVF will go HIGH on the clock the magnitude of either of the current Cartesian coordinate outputs exceed the maximum range. OVF will return LOW on the clock that the Cartesian output value(s) return within range. An overflow condition can only occur when RTP is LOW.

\overline{OERX} — *x-coordinate/Magnitude Data Output Enable*

When \overline{OERX} is LOW, RXOUT₁₅₋₀ is enabled for output. When \overline{OERX} is HIGH, RXOUT₁₅₋₀ is placed in a high-impedance state.

\overline{OEPY} — *y-coordinate/Phase Angle Data Output Enable*

When \overline{OEPY} is LOW, PYOUT₁₅₋₀ is enabled for output. When \overline{OEPY} is HIGH, PYOUT₁₅₋₀ is placed in a high-impedance state.

FIGURE 1B. OUTPUT FORMATS

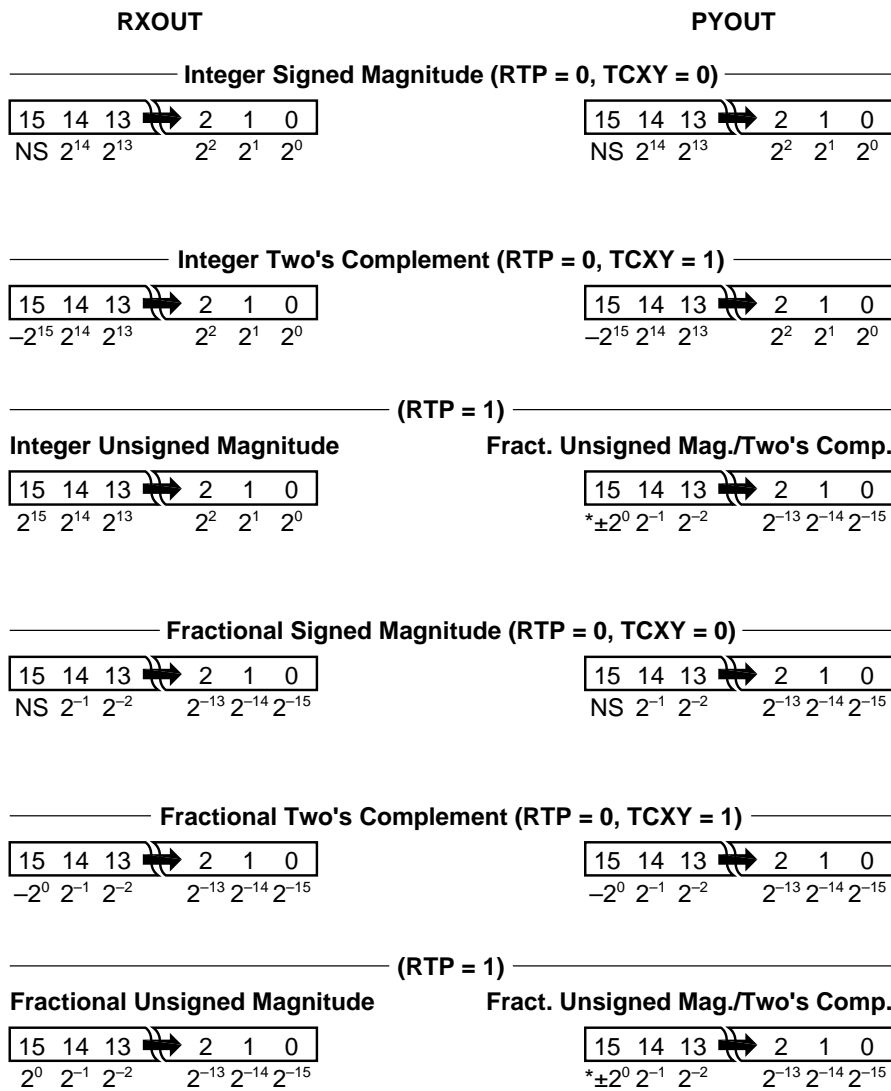

* $\pm 2^0$ denotes two's complement sign or highest magnitude bit. Since phase angles are modulo 2π and phase accumulator is modulo 2^{32} , this bit may be regarded as $\pm\pi$.
NS denotes negative sign. (i.e. '1' negates the number)

Conversion Ranges

The L2330 supports 16-bit unsigned radii and 16-bit signed Cartesian coordinates. Since the 16-bit rectangular coordinate space does not completely cover the polar space defined by 16-bit radii, certain values of “r” will not map correctly. This condition is indicated by the overflow (OVF) flag.

In Polar-to-Rectangular conversions, no overflow occurs for $r \leq 32767$ (7FFFH). Overflow will always occur when $r > 46341$ (B505H). Note that in signed magnitude mode $r = 46340$ (B504H) will also cause an overflow. For $32767 \leq r \leq 46340$, overflow may occur depending on the exact values of r and θ . Figure 2 shows, for the first quadrant, these three regions: A = no overflow (correct conversion), B = possible overflow, C = overflow. The other quadrants are mapped in a similar manner.

When in signed magnitude mode, the overflows on the other three quadrants are the same as in the first. This occurs because the signed magnitude number system is symmetric about zero. For example, if a given r and angle θ cause an overflow, the same r will cause an overflow for the angles $-\theta, \pi+\theta, \pi-\theta$.

However, when in two’s complement mode, the overflows aren’t quite the same. This occurs because the two’s

complement number system is not symmetric about zero. For example, if the X or Y component of the input is -32768 (8000H), no overflow occurs. But if the X or Y component of the input is $+32768$, overflow does occur.

When converting from Rectangular-to-Polar, if both inputs are zero the radius is zero but the angle is not defined. The L2330 will output 4707H in this case. Since the angle is not defined for a zero length vector, this is not an error.

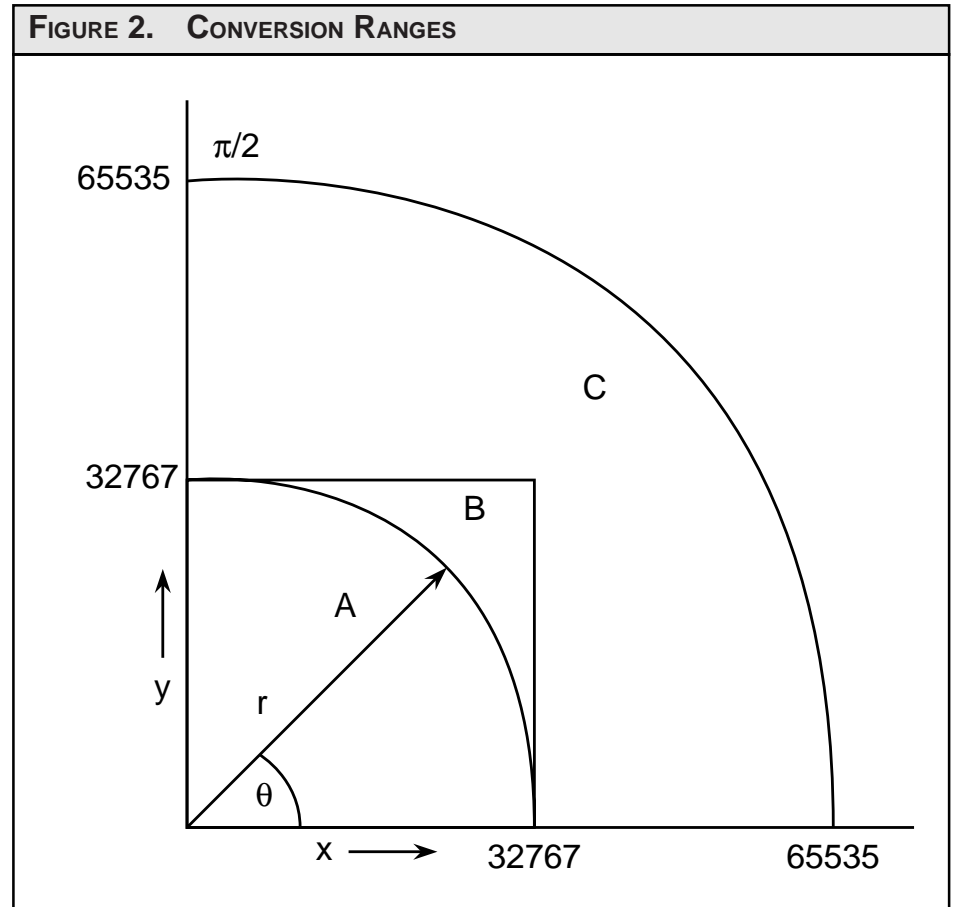

Internal Precision

When performing a coordinate transformation, inaccuracies are introduced by a combination of quantization and approximation errors. The accuracy of a coordinate transformer is dependent on the word length used for the input variables, the word length used for internal calculations, as well as the number of iterations or steps performed. Truncation errors are due to the finite word length, and approximation errors are due to the finite number of iterations. For example, in the case of performing a polar-to-rectangular transformation, the accuracy of the rotation will be determined by how closely the input rotation angle was approximated by the summation of sub-rotation angles.

In this study, we examine the effectiveness of 16-bit internal precision versus 24-bit internal precision. 10,000 random Rectangular coordinates were converted to Polar and back to Rectangular. The resulting Rectangular coordinates from this double conversion were then compared to the original

Rectangular coordinates input to the device. These vectors, with maximum word width of 16-bits, were sent through a 16-bit internal processor versus a 24-bit internal processor. The Rectangular coordinates were limited to the following conditions:

$$-32769 < x < 32768$$

$$-32769 < y < 32768$$

Using the 16-bit internal processor, the resulting Rectangular coordinates were compared to the original Rectangular coordinates (see Table 3). Using the 24-bit internal processor, the resulting

Rectangular coordinates were compared to the original Rectangular coordinates (see Table 3). By way of comparison between the 16-bit internal processor and the 24-bit internal processor, we find that the 24-bit internal processor is significantly more accurate. This accuracy is due to internal word length. During coordinate transformation, the number of bits truncated within a 24-bit internal processor are much smaller than in a 16-bit internal processor resulting in smaller error.

TABLE 3. DOUBLE CONVERSION ERROR		
Error	Internal 16-bit	Internal 24-bit
Mean Error (X)	0.0216	-0.0118
Mean Error (Y)	-0.0036	-0.0028
Mean Absolute Error (X)	1.5736	0.5116
Mean Absolute Error (Y)	1.0756	0.5160
Root Mean Square Error (X)	2.0168	0.7664
Root Mean Square Error (Y)	1.4356	0.7738
Max Error (X)	6.0/-7.0	3.0/-3.0
Max Error (Y)	5.0/-5.0	3.0/-3.0
Standard Deviation of Error (X)	2.0168	0.7664
Standard Deviation of Error (Y)	1.4357	0.7739

Circle Test

When performing a polar-to-rectangular transformation, a 24-bit internal processor proves to be significantly more accurate than a 16-bit internal processor.

In this study, we compare how accurately a coordinate transformer with a 16-bit internal processor versus a 24-bit internal processor can calculate all the coordinates of a circle. By setting the radius to 7FFFH (maximum before overflow), θ is incremented using the accumulator of the L2330 in steps of 0000 4000H until all the points of a full circle are calculated into rectangular coordinates.

The resulting rectangular coordinates were plotted and graphed. A graphical representation of the resulting vectors for both 16-bit and 24-bit internal processors are compared near 45°. Theoretically, a perfect circle is the desired output but when the resulting vectors from a coordinate transformer with 16-bit internal processor are graphed and displayed as shown in Figure 3, we see significant errors due to the inherent properties of a digital coordinate transformation system. In comparison, the 24-bit internal processor proves to be significantly more accurate than a 16-bit internal processor due to minimization of truncation errors. In many applications, this margin of error is of great significance especially when being used in applications such as medical ultrasound or modulation techniques.

Data values for Figure 3 and Figure 4 are shown in Table 4. By looking at these values, we observe the step resolution on a 16-bit internal processor is not 1 unit in the x and y. In most cases, the minimum step resolution is 2 units in the x and y. On the other hand,

step resolution on a 24-bit internal processor is 1 unit in the x and y thus resulting in greater accuracy.

The minimum theoretical angle resolution that could be produced is 0.00175° when $x = 7FFFH$ and $y = 1H$. A 16-bit internal processor can produce a minimum angle resolution of only

0.00549° and will not be able to properly calculate the theoretical minimum angle resolution. On the other hand, a 24-bit internal processor can produce a minimum angle resolution of 0.00002° and could therefore properly calculate the theoretical minimum angle resolution.

FIGURE 3. CIRCLE TEST RESULT NEAR 45° (16-BIT INTERNAL PROCESSOR)

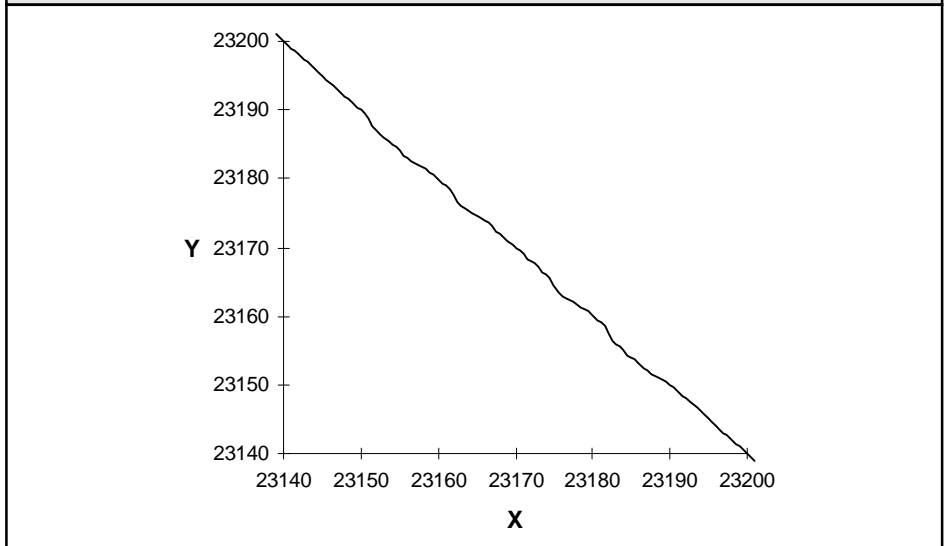

FIGURE 4. CIRCLE TEST RESULT NEAR 45° (24-BIT INTERNAL PROCESSOR)

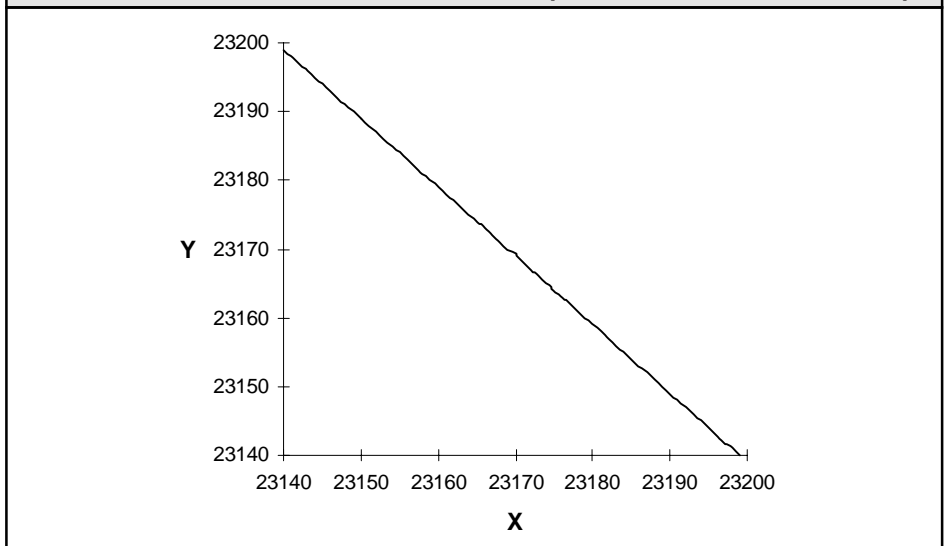

TABLE 4. RESULTANT DATA VALUES OF CIRCLE TEST NEAR 45°							
16-bit Internal Processor				24-bit Internal Processor			
x	x (HEX)	y	y (HEX)	x	x (HEX)	y	y (HEX)
23201	5AA1	23139	5A63	23199	5A9F	23140	5A64
23199	5A9F	23141	5A65	23198	5A9E	23141	5A65
23199	5A9F	23141	5A65	23198	5A9E	23141	5A65
23199	5A9F	23141	5A65	23197	5A9D	23142	5A66
23199	5A9F	23141	5A65	23197	5A9D	23142	5A66
23197	5A9D	23143	5A67	23196	5A9C	23143	5A67
23197	5A9D	23143	5A67	23196	5A9C	23143	5A67
23197	5A9D	23143	5A67	23195	5A9B	23144	5A68
23197	5A9D	23143	5A67	23194	5A9A	23145	5A69
23195	5A9B	23145	5A69	23194	5A9A	23145	5A69
23195	5A9B	23145	5A69	23194	5A9A	23145	5A69
23195	5A9B	23145	5A69	23193	5A99	23146	5A6A
23195	5A9B	23145	5A69	23192	5A98	23147	5A6B
23192	5A98	23148	5A6C	23191	5A97	23148	5A6C
23192	5A98	03148	5A6C	23191	5A97	23148	5A6C
23192	5A98	23148	5A6C	23191	5A97	23148	5A6C
23192	5A98	23148	5A6C	23190	5A96	23149	5A6D
23190	5A96	23150	5A6E	23189	5A95	23150	5A6E
23190	5A96	23150	5A6E	23189	5A95	23150	5A6E
23190	5A96	23150	5A6E	23189	5A95	23150	5A6E
23190	5A96	23150	5A6E	23188	5A94	23151	5A6F
23187	5A93	23152	5A70	23187	5A93	23152	5A70
23187	5A93	23152	5A70	23186	5A92	23153	5A71
23187	5A93	23152	5A70	23186	5A92	23153	5A71
23187	5A93	23152	5A70	23186	5A92	23153	5A71
23185	5A91	23154	5A72	23185	5A91	23154	5A72
23185	5A91	23154	5A72	23184	5A90	23155	5A73
23185	5A91	23154	5A72	23184	5A90	23155	5A73
23185	5A91	23154	5A72	23184	5A90	23155	5A73
23183	5A8F	23156	5A74	23183	5A8F	23156	5A74

Coordinate Transformer

MAXIMUM RATINGS <i>Above which useful life may be impaired (Notes 1, 2, 3, 8)</i>	
Storage temperature	-65°C to +150°C
Operating ambient temperature	-55°C to +125°C
V _{CC} supply voltage with respect to ground	-0.5 V to +7.0 V
Input signal with respect to ground	-0.5 V to V _{CC} + 0.5 V
Signal applied to high impedance output	-0.5 V to V _{CC} + 0.5 V
Output current into low outputs	25 mA
Latchup current	> 400 mA

OPERATING CONDITIONS <i>To meet specified electrical and switching characteristics</i>		
Mode	Temperature Range (Ambient)	Supply Voltage
Active Operation, Commercial	0°C to +70°C	4.75 V ≤ V _{CC} ≤ 5.25 V
Active Operation, Military	-55°C to +125°C	4.50 V ≤ V _{CC} ≤ 5.50 V

ELECTRICAL CHARACTERISTICS <i>Over Operating Conditions (Note 4)</i>						
Symbol	Parameter	Test Condition	Min	Typ	Max	Unit
V _{OH}	Output High Voltage	V _{CC} = Min., I _{OH} = -2.0 mA	2.4			V
V _{OL}	Output Low Voltage	V _{CC} = Min., I _{OL} = 4.0 mA			0.4	V
V _{IH}	Input High Voltage		2.0		V _{CC}	V
V _{IL}	Input Low Voltage	(Note 3)	0.0		0.8	V
I _{Ix}	Input Current	Ground ≤ V _{IN} ≤ V _{CC} (Note 12)			±10	μA
I _{OZ}	Output Leakage Current	Ground ≤ V _{OUT} ≤ V _{CC} (Note 12)			±10	μA
I _{CC1}	V _{CC} Current, Dynamic	(Notes 5, 6)			95	mA
I _{CC2}	V _{CC} Current, Quiescent	(Note 7)			5	mA
C _{IN}	Input Capacitance	T _A = 25°C, f = 1 MHz			10	pF
C _{OUT}	Output Capacitance	T _A = 25°C, f = 1 MHz			10	pF

SWITCHING CHARACTERISTICS

COMMERCIAL OPERATING RANGE (0°C to +70°C) Notes 9, 10 (ns)							
Symbol Parameter		L2330–					
		50*		25		20	
		Min	Max	Min	Max	Min	Max
t _{CYC}	Cycle Time	50		25		20	
t _{PWL}	Clock Pulse Width Low	10		8		7	
t _{PWH}	Clock Pulse Width High	8		7		6	
t _S	Input Setup Time	12		7		6	
t _H	Input Hold Time	1		0		0	
t _D	Output Delay		22		18		16
t _{ENA}	Three-State Output Enable Delay (Note 11)		13		13		13
t _{DIS}	Three-State Output Disable Delay (Note 11)		13		13		13

MILITARY OPERATING RANGE (–55°C to +125°C) Notes 9, 10 (ns)							
Symbol Parameter		L2330–					
		50*		25*		20*	
		Min	Max	Min	Max	Min	Max
t _{CYC}	Cycle Time	50		25		20	
t _{PWL}	Clock Pulse Width Low	11		9		7	
t _{PWH}	Clock Pulse Width High	8		7		6	
t _S	Input Setup Time	13		7		6	
t _H	Input Hold Time	2		2		1	
t _D	Output Delay		25		20		18
t _{ENA}	Three-State Output Enable Delay (Note 11)		15		14		13
t _{DIS}	Three-State Output Disable Delay (Note 11)		15		14		13

*DISCONTINUED SPEED GRADE

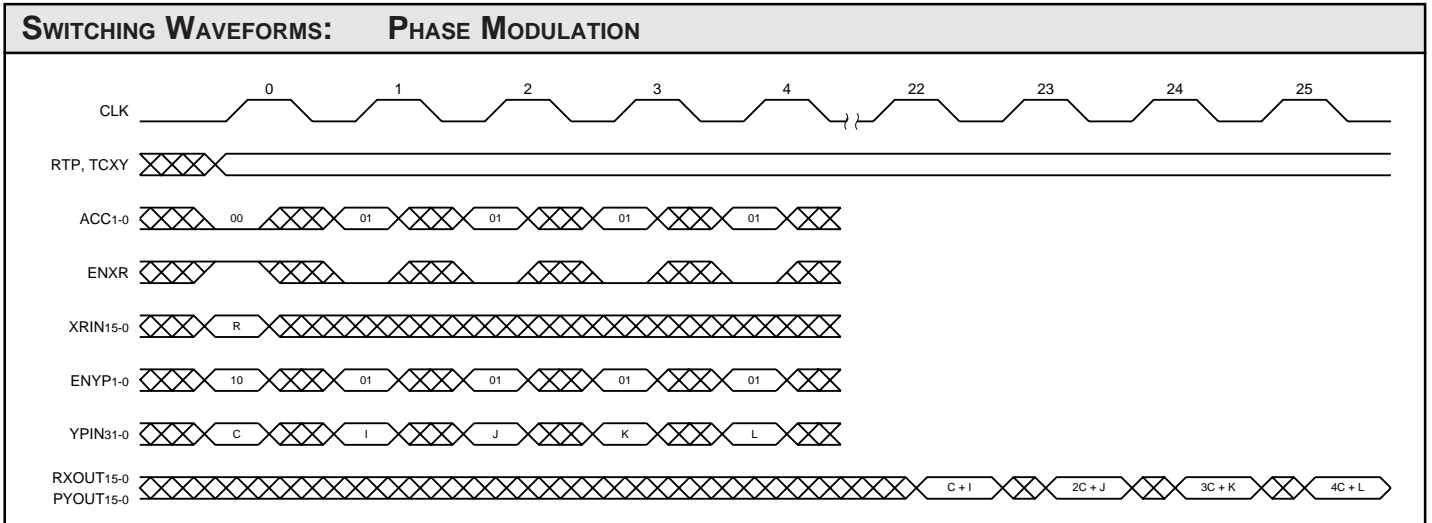
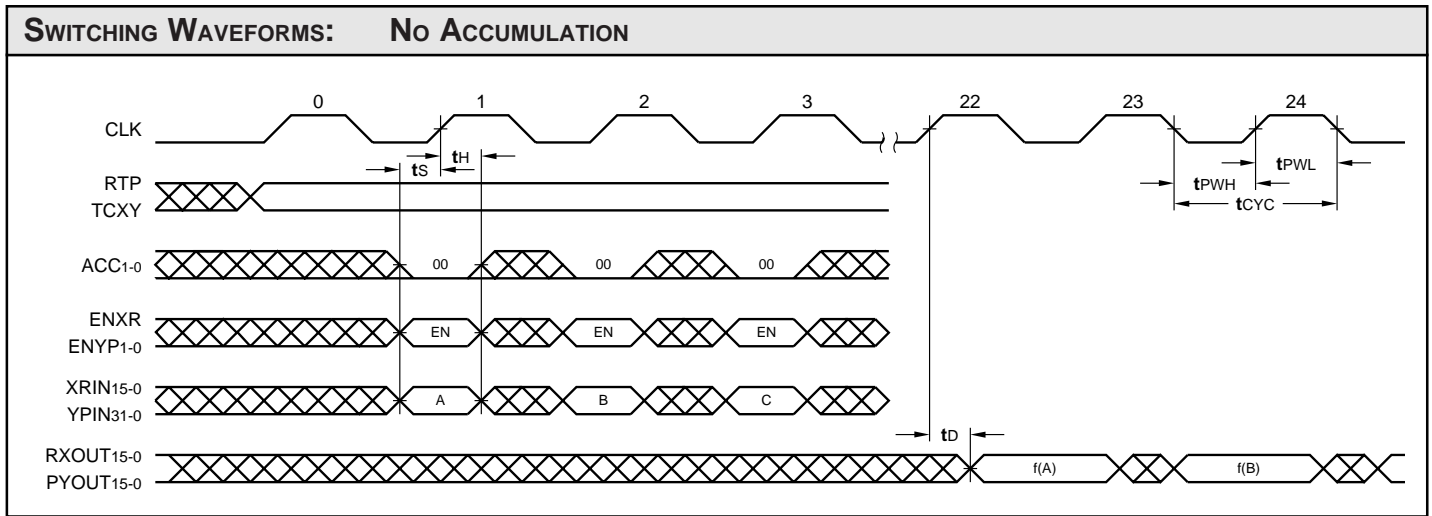

NOTES

1. Maximum Ratings indicate stress specifications only. Functional operation of these products at values beyond those indicated in the Operating Conditions table is not implied. Exposure to maximum rating conditions for extended periods may affect reliability.
2. The products described by this specification include internal circuitry designed to protect the chip from damaging substrate injection currents and accumulations of static charge. Nevertheless, conventional precautions should be observed during storage, handling, and use of these circuits in order to avoid exposure to excessive electrical stress values.
3. This device provides hard clamping of transient undershoot and overshoot. Input levels below ground or above VCC will be clamped beginning at -0.6 V and VCC + 0.6 V. The device can withstand indefinite operation with inputs in the range of -0.5 V to +7.0 V. Device operation will not be adversely affected, however, input current levels will be well in excess of 100 mA.
4. Actual test conditions may vary from those designated but operation is guaranteed as specified.
5. Supply current for a given application can be accurately approximated by:

$$\frac{NCV^2F}{4}$$
 where
 - N = total number of device outputs
 - C = capacitive load per output
 - V = supply voltage
 - F = clock frequency
6. Tested with all outputs changing every cycle and no load, at a 20 MHz clock rate.
7. Tested with all inputs within 0.1 V of VCC or Ground, no load.
8. These parameters are guaranteed but not 100% tested.

9. AC specifications are tested with input transition times less than 3 ns, output reference levels of 1.5 V (except tDIS test), and input levels of nominally 0 to 3.0 V. Output loading may be a resistive divider which provides for specified IOH and IOL at an output voltage of VOH min and VOL max respectively. Alternatively, a diode bridge with upper and lower current sources of IOH and IOL respectively, and a balancing voltage of 1.5 V may be used. Parasitic capacitance is 30 pF minimum, and may be distributed.

This device has high-speed outputs capable of large instantaneous current pulses and fast turn-on/turn-off times. As a result, care must be exercised in the testing of this device. The following measures are recommended:

- a. A 0.1 µF ceramic capacitor should be installed between VCC and Ground leads as close to the Device Under Test (DUT) as possible. Similar capacitors should be installed between device VCC and the tester common, and device ground and tester common.
- b. Ground and VCC supply planes must be brought directly to the DUT socket or contactor fingers.
- c. Input voltages should be adjusted to compensate for inductive ground and VCC noise to maintain required DUT input levels relative to the DUT ground pin.

10. Each parameter is shown as a minimum or maximum value. Input requirements are specified from the point of view of the external system driving the chip. Setup time, for example, is specified as a minimum since the external system must supply at least that much time to meet the worst-case requirements of all parts. Responses from the internal circuitry are specified from the point of view of the device. Output delay, for example, is specified as a maximum since worst-case operation of any device always provides data within that time.

11. For the tENA test, the transition is measured to the 1.5 V crossing point with datasheet loads. For the tDIS test, the transition is measured to the ±200mV level from the measured steady-state output voltage with ±10mA loads. The balancing voltage, VTH, is set at 3.5 V for Z-to-0 and 0-to-Z tests, and set at 0 V for Z-to-1 and 1-to-Z tests.

12. These parameters are only tested at the high temperature extreme, which is the worst case for leakage current.

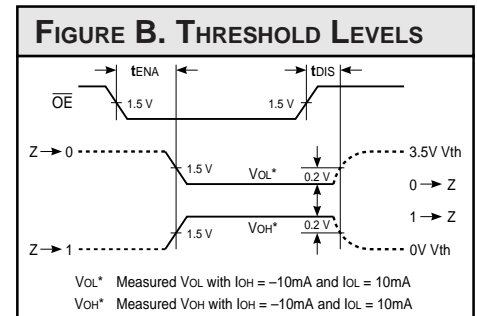
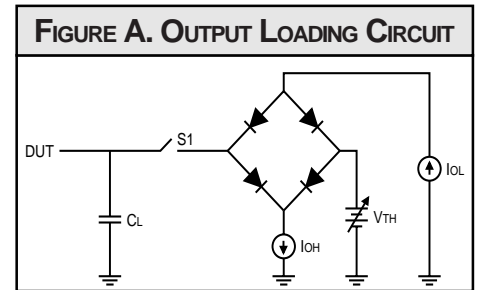

ORDERING INFORMATION

120-pin

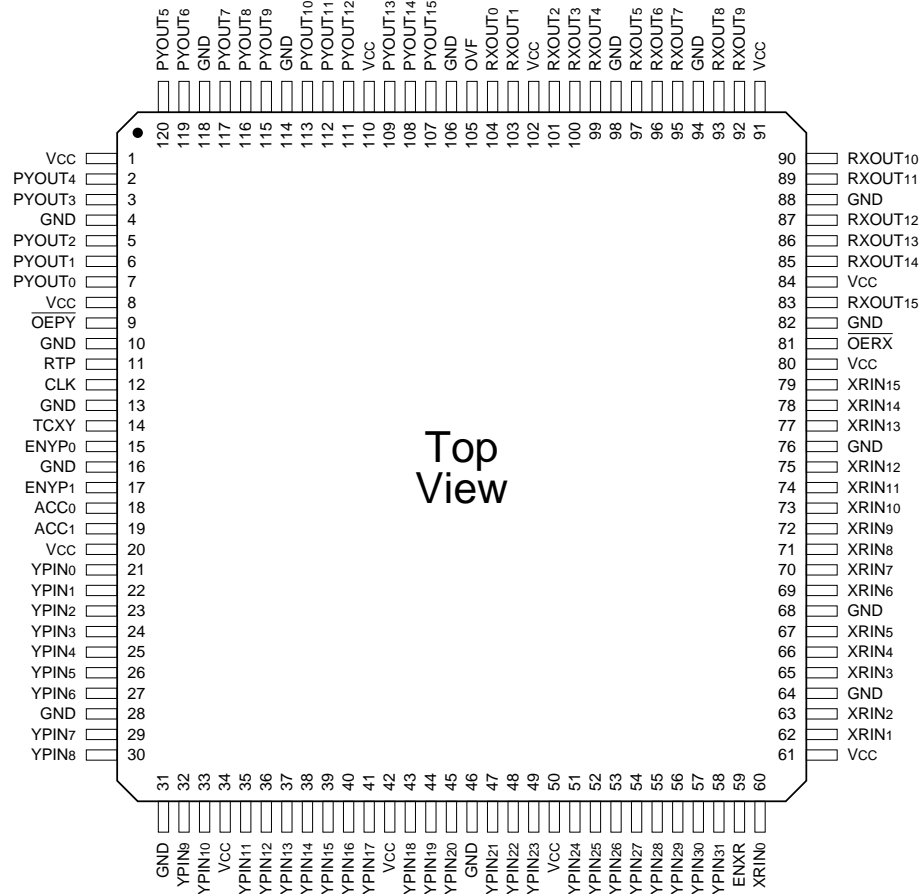

Top View

Speed	Plastic Quad Flatpack (Q1)
	0°C to +70°C — COMMERCIAL SCREENING
25 ns	L2330QC25
20 ns	L2330QC20

ORDERING INFORMATION

120-pin

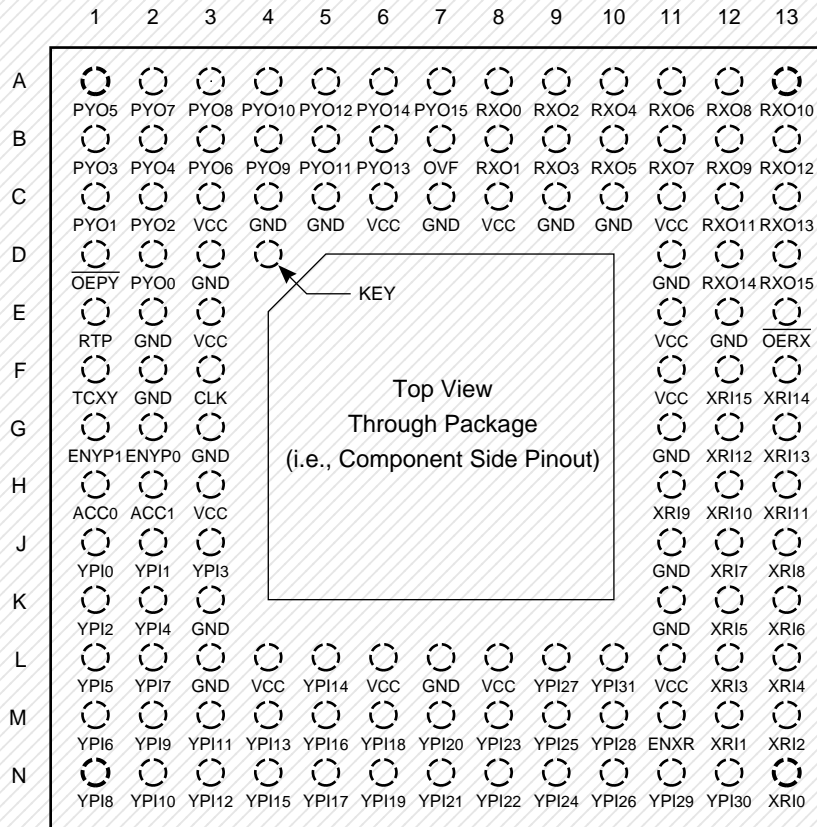

Discontinued Package

Speed	Ceramic Pin Grid Array (G4)
	0°C to +70°C — COMMERCIAL SCREENING
	-55°C to +125°C — COMMERCIAL SCREENING
	-55°C to +125°C — MIL-STD-883 COMPLIANT