

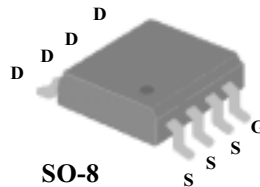

- ▼ Simple Drive Requirement
- ▼ Low On-resistance
- ▼ Fast Switching



|              |              |
|--------------|--------------|
| $BV_{DSS}$   | -30V         |
| $R_{DS(ON)}$ | 50m $\Omega$ |
| $I_D$        | $\pm 5.3A$   |

### Description

The Advanced Power MOSFETs from APEC provide the designer with the best combination of fast switching, ruggedized device design, low on-resistance and cost-effectiveness.

The SO-8 package is universally preferred for all commercial-industrial surface mount applications and suited for low voltage applications such as DC/DC converters.

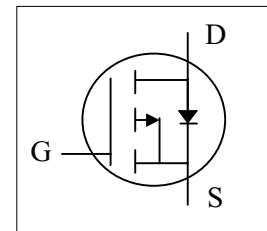

### Absolute Maximum Ratings

| Symbol               | Parameter                            | Rating     | Units         |
|----------------------|--------------------------------------|------------|---------------|
| $V_{DS}$             | Drain-Source Voltage                 | - 30       | V             |
| $V_{GS}$             | Gate-Source Voltage                  | $\pm 20$   | V             |
| $I_D@T_A=25^\circ C$ | Continuous Drain Current             | $\pm 5.3$  | A             |
| $I_D@T_A=70^\circ C$ | Continuous Drain Current             | $\pm 4.7$  | A             |
| $I_{DM}$             | Pulsed Drain Current <sup>1</sup>    | $\pm 20$   | A             |
| $P_D@T_A=25^\circ C$ | Total Power Dissipation              | 2.5        | W             |
|                      | Linear Derating Factor               | 0.02       | W/ $^\circ C$ |
| $T_{STG}$            | Storage Temperature Range            | -55 to 150 | $^\circ C$    |
| $T_J$                | Operating Junction Temperature Range | -55 to 150 | $^\circ C$    |

### Thermal Data

| Symbol        | Parameter                           | Value   | Unit         |
|---------------|-------------------------------------|---------|--------------|
| $R_{thj-amb}$ | Thermal Resistance Junction-ambient | Max. 50 | $^\circ C/W$ |



**Electrical Characteristics@T<sub>j</sub>=25°C(unless otherwise specified)**

| Symbol                              | Parameter   | Test Conditions   | Min. | Typ.   | Max. | Units |
|-------------------------------------|---|---|------|--------|------|-------|
| BV <sub>DSS</sub>                   | Drain-Source Breakdown Voltage                      | V <sub>GS</sub> =0V, I <sub>D</sub> =-250uA               | -30  | -      | -    | V     |
| ΔBV <sub>DSS</sub> /ΔT <sub>j</sub> | Breakdown Voltage Temperature Coefficient           | Reference to 25°C, I <sub>D</sub> =-1mA                   | -    | -0.037 | -    | V/°C  |
| R <sub>DS(ON)</sub>                 | Static Drain-Source On-Resistance                   | V <sub>GS</sub> =-10V, I <sub>D</sub> =-5.3A              | -    | -      | 50   | mΩ    |
|                                     |   | V <sub>GS</sub> =-4.5V, I <sub>D</sub> =-4.2A             | -    | -      | 90   | mΩ    |
| V <sub>GS(th)</sub>                 | Gate Threshold Voltage                              | V <sub>DS</sub> =V <sub>GS</sub> , I <sub>D</sub> =-250uA | -1   | -      | -3   | V     |
| g <sub>fs</sub>                     | Forward Transconductance                            | V <sub>DS</sub> =-10V, I <sub>D</sub> =-5.3A              | -    | 10     | -    | S     |
| I <sub>DSS</sub>                    | Drain-Source Leakage Current (T <sub>j</sub> =25°C) | V <sub>DS</sub> =-30V, V <sub>GS</sub> =0V                | -    | -      | -1   | uA    |
|                                     | Drain-Source Leakage Current (T <sub>j</sub> =70°C) | V <sub>DS</sub> =-24V, V <sub>GS</sub> =0V                | -    | -      | -25  | uA    |
| I <sub>GSS</sub>                    | Gate-Source Leakage                                 | V <sub>GS</sub> = ± 20V                                   | -    | -      | ±100 | nA    |
| Q <sub>g</sub>                      | Total Gate Charge <sup>2</sup>                      | I <sub>D</sub> =-5.3A                                     | -    | 28     | -    | nC    |
| Q <sub>gs</sub>                     | Gate-Source Charge                                  | V <sub>DS</sub> =-15V                                     | -    | 3      | -    | nC    |
| Q <sub>gd</sub>                     | Gate-Drain ("Miller") Charge                        | V <sub>GS</sub> =-10V                                     | -    | 7      | -    | nC    |
| t <sub>d(on)</sub>                  | Turn-on Delay Time <sup>2</sup>                     | V <sub>DS</sub> =-15V                                     | -    | 12     | -    | ns    |
| t <sub>r</sub>                      | Rise Time   | I <sub>D</sub> =-1A                                       | -    | 20     | -    | ns    |
| t <sub>d(off)</sub>                 | Turn-off Delay Time                                 | R <sub>G</sub> =6Ω, V <sub>GS</sub> =-10V                 | -    | 45     | -    | ns    |
| t <sub>f</sub>                      | Fall Time   | R <sub>D</sub> =15Ω                                       | -    | 27     | -    | ns    |
| C <sub>iss</sub>                    | Input Capacitance                                   | V <sub>GS</sub> =0V                                       | -    | 745    | -    | pF    |
| C <sub>oss</sub>                    | Output Capacitance                                  | V <sub>DS</sub> =-15V                                     | -    | 440    | -    | pF    |
| C <sub>rss</sub>                    | Reverse Transfer Capacitance                        | f=1.0MHz  | -    | 120    | -    | pF    |

**Source-Drain Diode**

| Symbol          | Parameter   | Test Conditions  | Min. | Typ.  | Max. | Units |
|-----------------|---|--|------|-------|------|-------|
| I <sub>S</sub>  | Continuous Source Current ( Body Diode )          | V <sub>D</sub> =V <sub>G</sub> =0V , V <sub>S</sub> =-1.2V       | -    | -     | -2.6 | A     |
| I <sub>SM</sub> | Pulsed Source Current ( Body Diode ) <sup>1</sup> |  | -    | -     | -20  | A     |
| V <sub>SD</sub> | Forward On Voltage <sup>2</sup>                   | T <sub>j</sub> =25°C, I <sub>S</sub> =-2.6A, V <sub>GS</sub> =0V | -    | -0.75 | -1.2 | V     |

**Notes:**

- 1.Pulse width limited by safe operating area.
- 2.Pulse width ≤300us , duty cycle ≤2%.

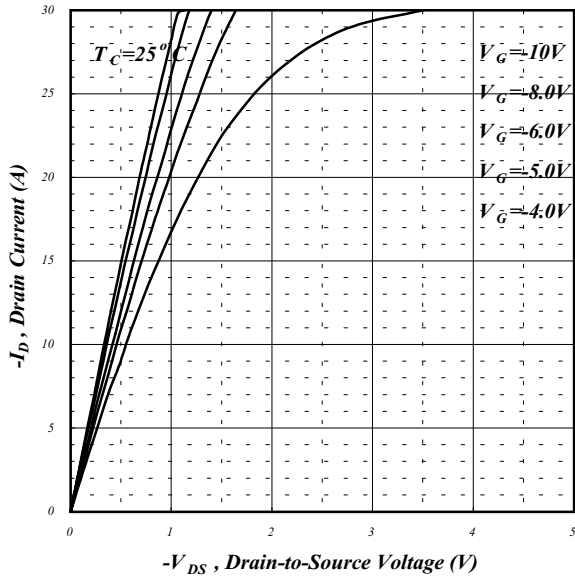

Fig 1. Typical Output Characteristics

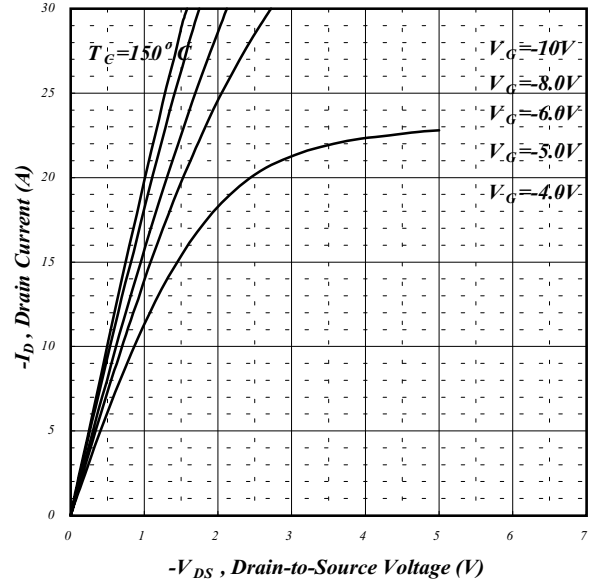

Fig 2. Typical Output Characteristics

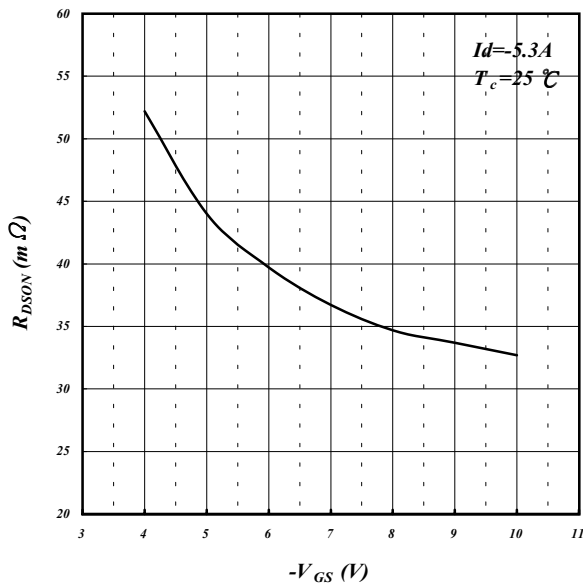

Fig 3. On-Resistance v.s. Gate Voltage

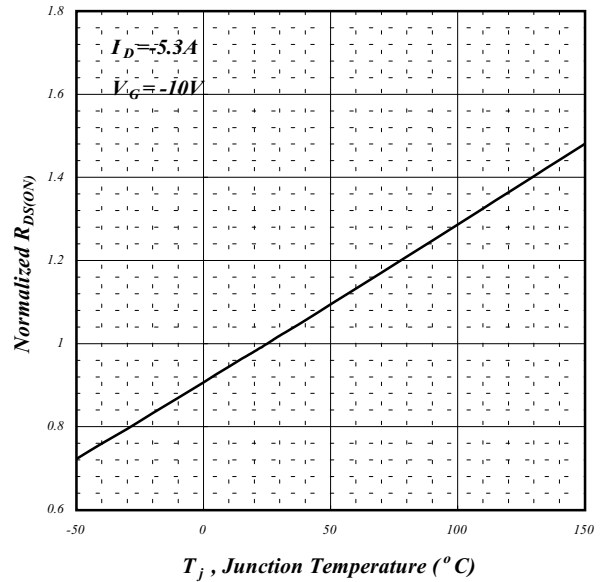

Fig 4. Normalized On-Resistance v.s. Junction Temperature

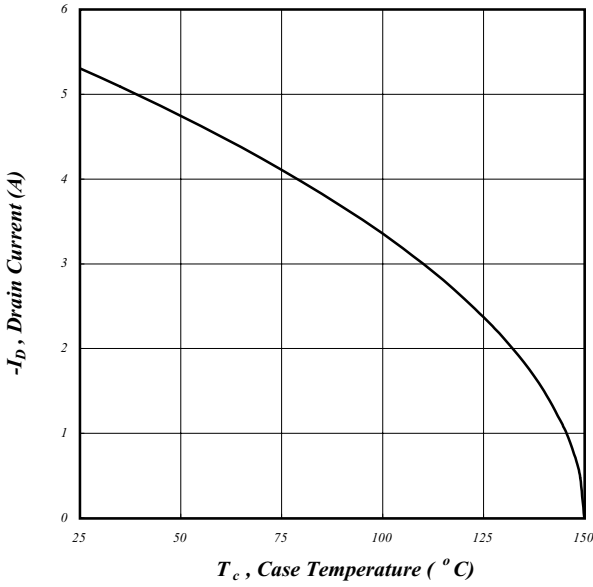

Fig 5. Maximum Drain Current v.s. Case Temperature

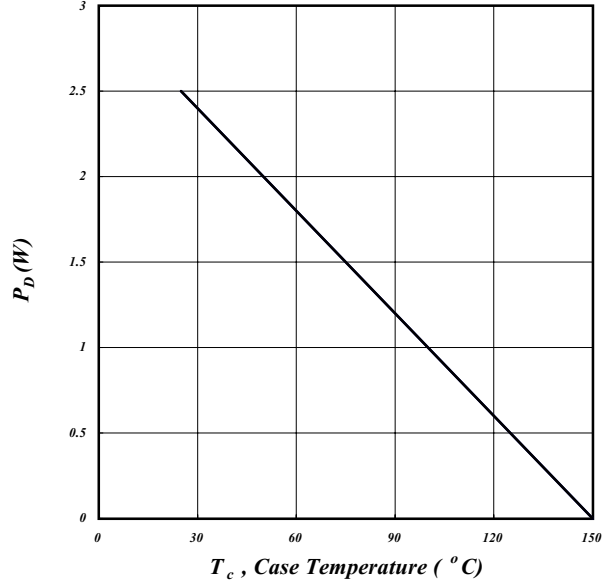

Fig 6. Typical Power Dissipation

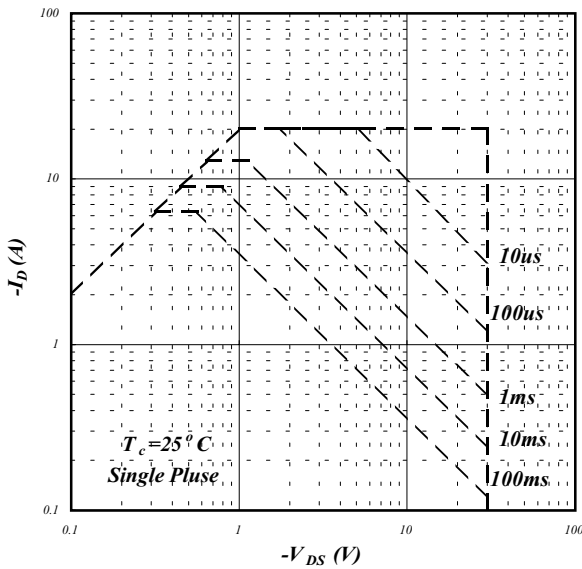

Fig 7. Maximum Safe Operating Area

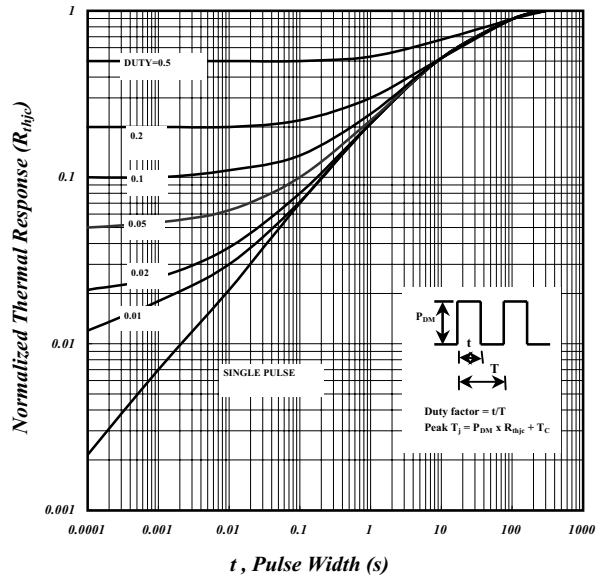

Fig 8. Effective Transient Thermal Impedance

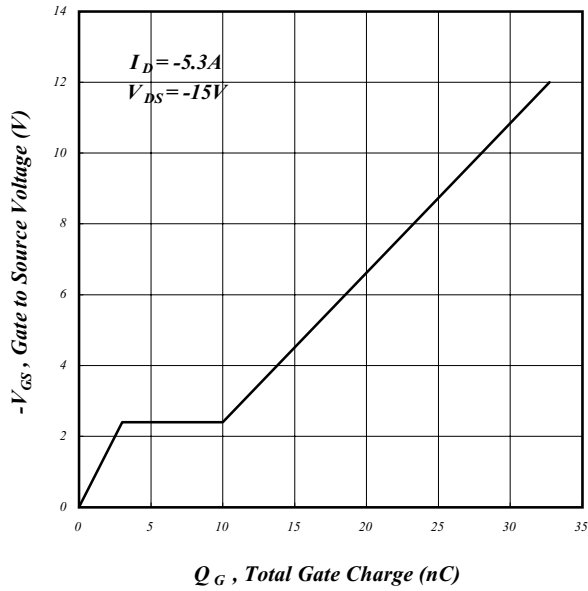

Fig 9. Gate Charge Characteristics

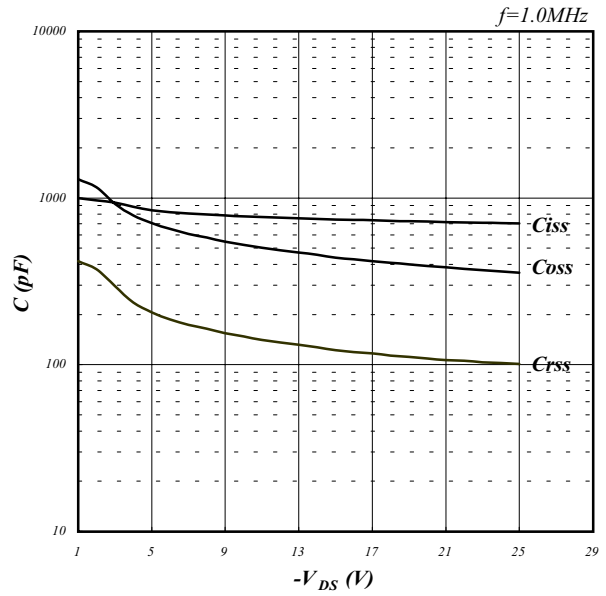

Fig 10. Typical Capacitance Characteristics

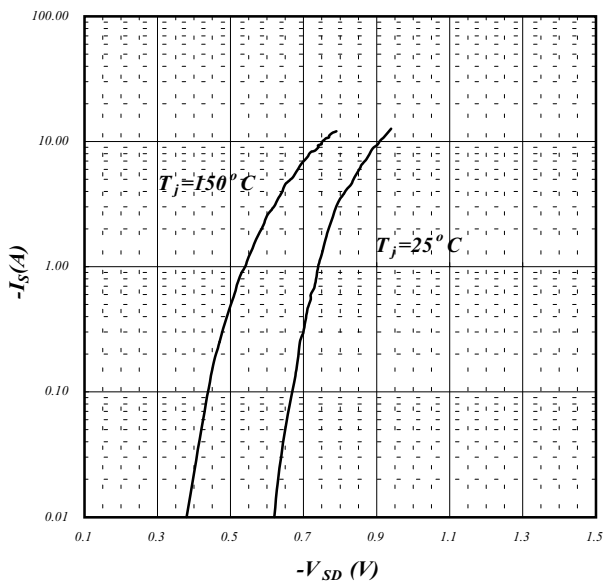

Fig 11. Forward Characteristic of Reverse Diode

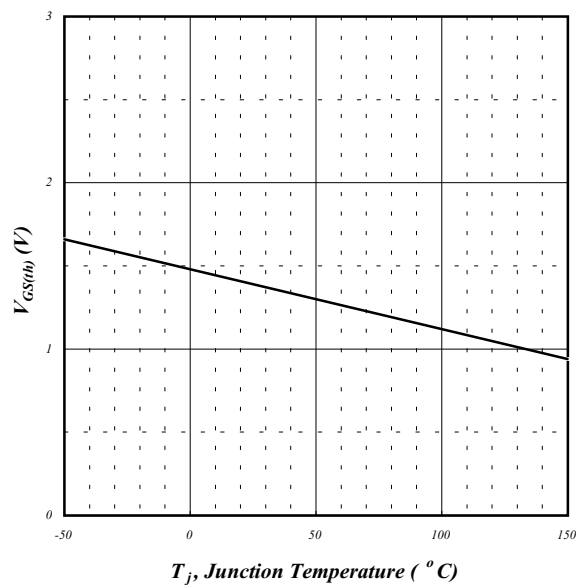

Fig 12. Gate Threshold Voltage v.s. Junction Temperature

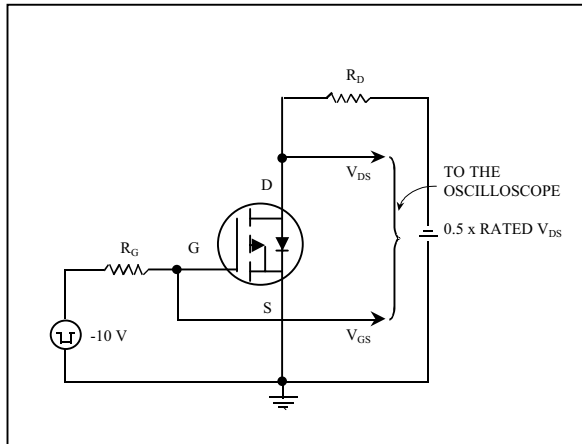

Fig 13. Switching Time Circuit

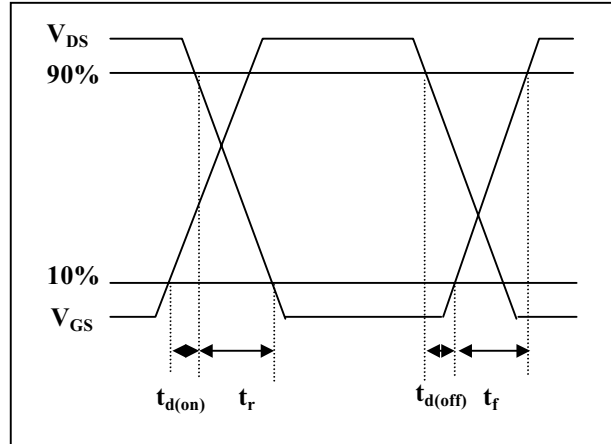

Fig 14. Switching Time Waveform

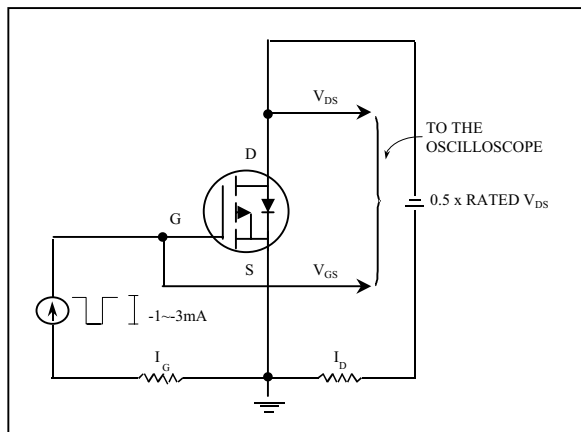

Fig 15. Gate Charge Circuit

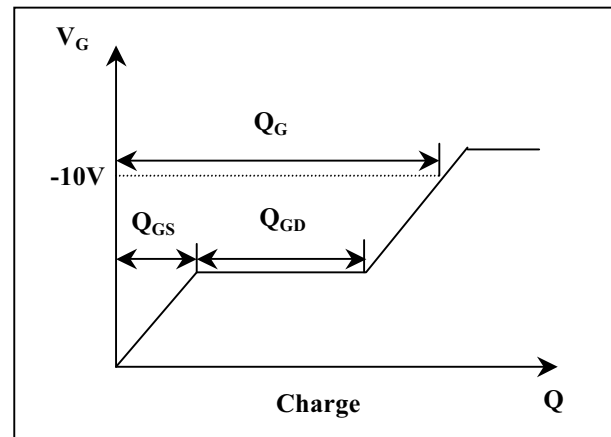

Fig 16. Gate Charge Waveform