



DIN Dimension Fuses To Specification DIN 43.625

This product group covers current limiting fuses with dimensions to DIN 43.625 and performance in compliance with IEC 282-1.

Advantages of Edison High Voltage Current - Limiting Fuses

The low power dissipation of Edison fuses ensures low temperature rise of switchgear in which they are incorporated.

The elements use the 'M' (metallurgical) effect, similar to that used in low voltage fuses. This ensures that, with melting on long time overloads, excessive temperatures are not reached and damage to switchgear components, such as epoxy encapsulating enclosures, is thus prevented. Fuses that do not employ this feature are not only hotter running by comparison but also usually need to employ a higher current rating of fuse for the same service; thus an Edison 40A fuse is equivalent in terms of thermal performance to many other types of 63A rating.

Edison fuses exhibit considerable limitation of current and I^2t under short-circuit conditions. The stress on circuit components is thereby minimized and the reduction of energy release at the fault reduces fire risks.

Switching (arc) voltages are appreciably less than permitted values and fall with lower values of recovery voltage. The use of, for example, 12kV fuse on 6/7.2kV systems is therefore permissible.

Striker Characteristics

The spring operated striker pin has a travel and energy output in compliance with the requirements of DIN 43625 and IEC 282-1.

Recommended Fuse Clips:

Refer to page 122 in this catalog.

Dimensions - Inches (mm)

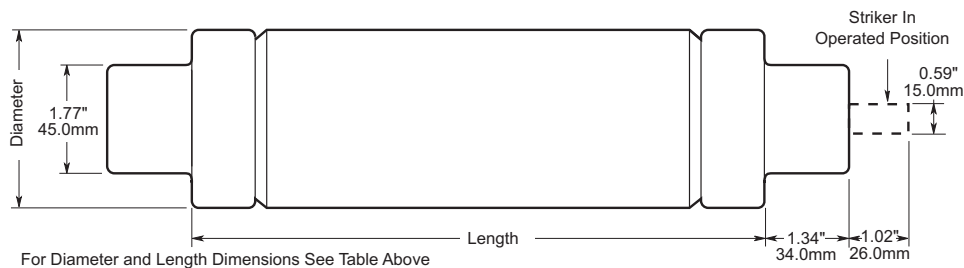

Ratings and Dimensions

kV	Catalog Numbers	Amp Ratings	Dimensions - in (mm) Diameter x Length	IR RMS Sym
3.6	3.6ADOSJ(amp)	6.3, 10, 16, 20, 25, 31.5, 40	2.00 x 7.56 (51 x 192)	50kA
	3.6WDOSJ(amp)	50, 63, 80, 100, 125	2.00 x 7.56 (51 x 192)	
	3.6WFOSJ(amp)	160, 200	3.00 x 7.56 (76 x 192)	
	3.6ADLSJ(amp)	25, 40	2.00 x 11.50 (51 x 292)	
	3.6WDLSJ(amp)	50, 63, 80, 100, 125	2.00 x 11.50 (51 x 292)	
	3.6WFLSJ(amp)	160, 200	3.00 x 11.50 (76 X 292)	
	3.6WKLSJ(amp)	250, 315, 400	3.00 x 11.50 (76 X 292)	
7.2	7.2DLSJ(amp)	6.3, 10, 16, 20, 25, 31.5, 40, 50, 63	2.00 x 11.50 (51 x 292)	40kA
	7.2FLSJ(amp)	80, 100, 125, 160	3.00 x 11.50 (76 x 292)	
	7.2WKMSJ(amp)	200, 225, 250, 315, 355	3.00 x 17.41 (76 x 442)	
12	12DLEJ(amp)	6.3, 10, 16, 20, 25, 31.5, 40, 50, 63	2.00 x 11.50 (51 x 292)	63kA
	12HLEJ(amp)	80, 100	2.52 x 11.50 (64 x 292)	
	12KLEJ(amp)	125	3.00 x 11.50 (76 x 292)	
	12XLEJ(amp)	160, 200	3.50 x 11.50 (88 x 292)	
17.5	17.5DLSJ(amp)	6.3, 10, 16, 20, 25, 31.5, 40	2.00 x 11.50 (51 x 292)	50kA
	17.5FLSJ(amp)	50	3.00 x 11.50 (76 x 292)	35.5kA
	17.5DMEJ(amp)	6.3, 10, 16, 20, 25, 31.5, 40, 50, 63	2.00 x 17.41 (51 x 442)	50kA
	17.5HMEJ(amp)	80, 100	2.52 x 17.41 (64 x 442)	
	17.5KMEJ(amp)	125	3.00 x 17.41 (76 x 442)	
24	24DMEJ(amp)	6.3, 10, 16, 20, 25, 31.5, 40, 50	2.00 x 17.41 (51 x 442)	50kA
	24HMEJ(amp)	63	2.52 x 17.41 (64 x 442)	
	24FMEJ(amp)	80, 100	3.00 x 17.41 (76 x 442)	
	24XMEJ(amp)	125, 160	3.46 x 17.41 (88 x 442)	
36	36DOSJ(amp)	3.15, 6.3, 10, 16, 20, 25	2.00 x 21.16 (51 x 537)	31.5kA
	36FQSJ(amp)	31.5, 40, 50	3.00 x 21.16 (51 x 537)	35.5kA
	36XQJ(amp)	63	3.46 x 21.16 (88 x 537)	20kA

Time-Current Characteristics–Average

For 3.6kV Fuses:

- 3.6ADOS 3.6WDLS
- 3.6WDOS 3.6WFLS
- 3.6ADLS 3.6WKLS

For 7.2kV Fuses:

- 7.2DLSJ
- 7.2FLSJ
- 7.2WKMSJ

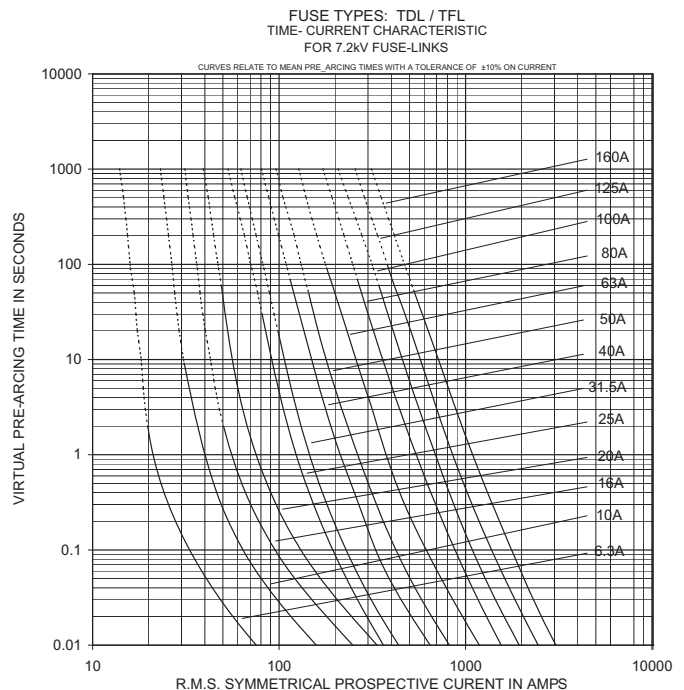
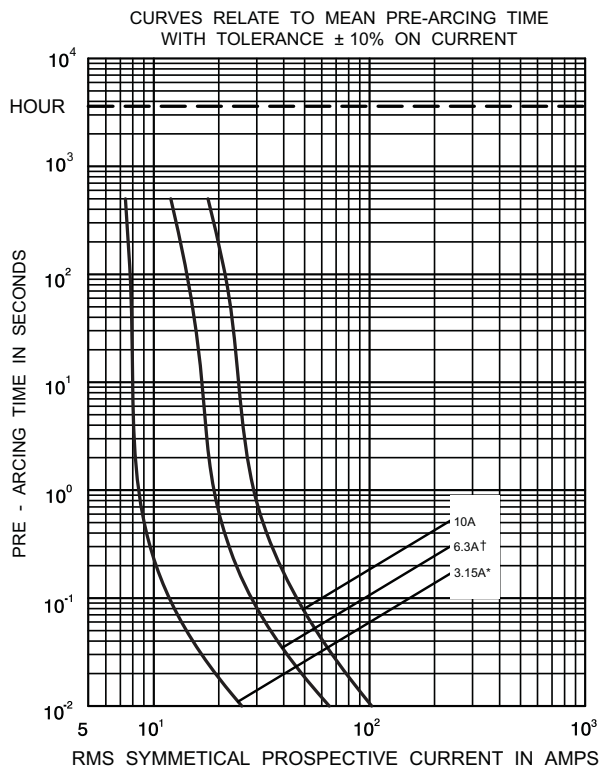

* Curve valid for all 3.15A ratings shown in the selection table.
† Curve valid for all 6.3A ratings shown in the selection table.

Time-Current Characteristics–Average

- For 12kV Fuses:
- 12TDLEJ
 - 12THLEJ
 - 12TKLEJ
- 12TXLEJ

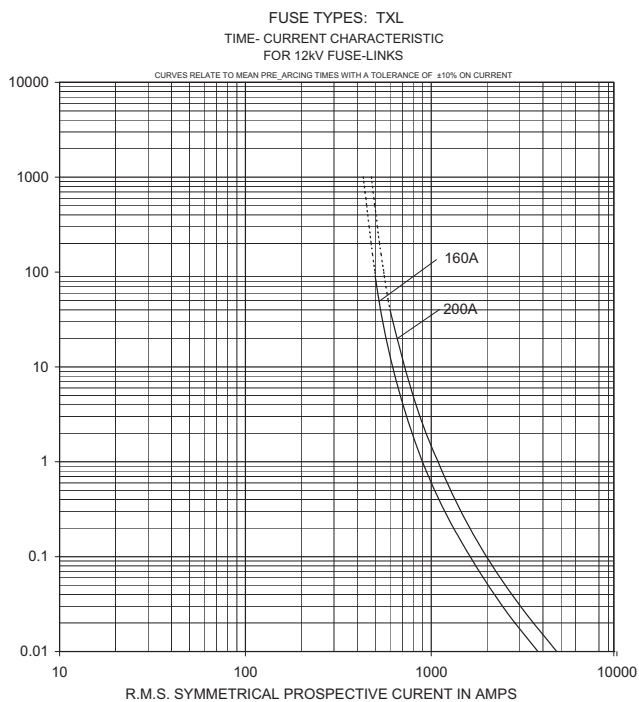
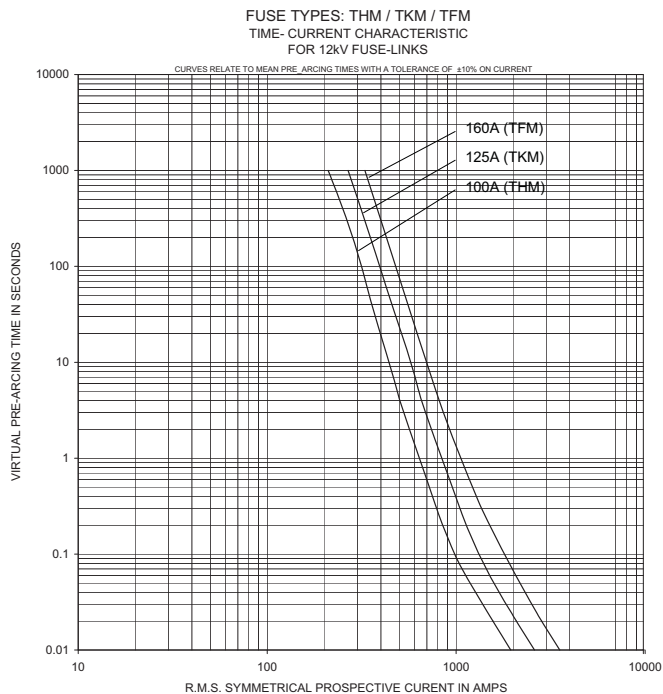
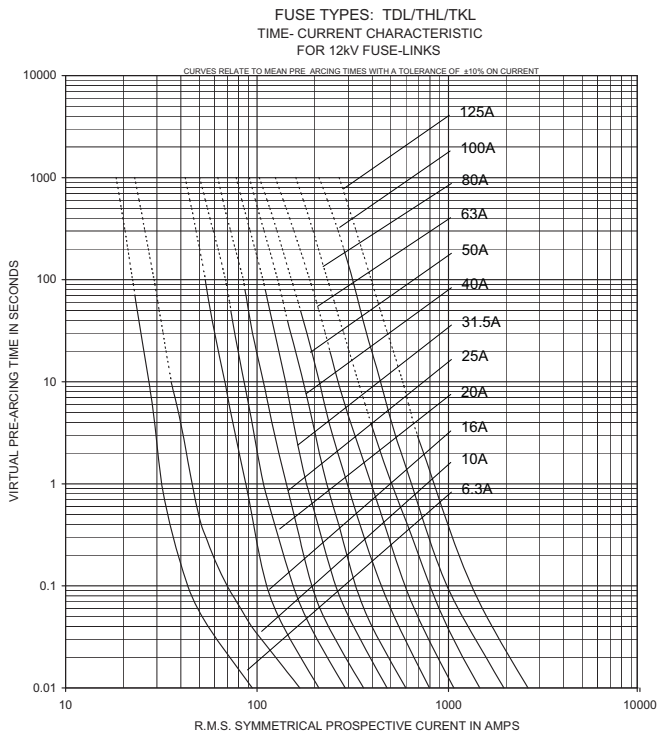

Time-Current Characteristics–Average

- For 17.5kV Fuses:
- 17.5TDLSJ
 - 17.5THMEJ
 - 17.5TFLSJ
 - 17.5TKMEJ
 - 17.5TDMEJ

FUSE TYPES: TDL
TIME-CURRENT CHARACTERISTIC
FOR 17.5KV FUSE-LINKS

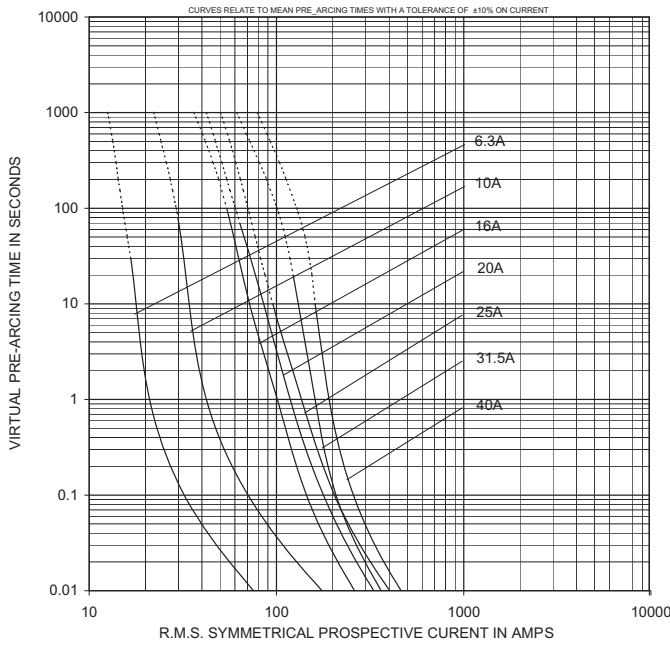

FUSE TYPES: TDM/THM/TKM
TIME-CURRENT CHARACTERISTIC
FOR 17.5KV FUSE-LINKS

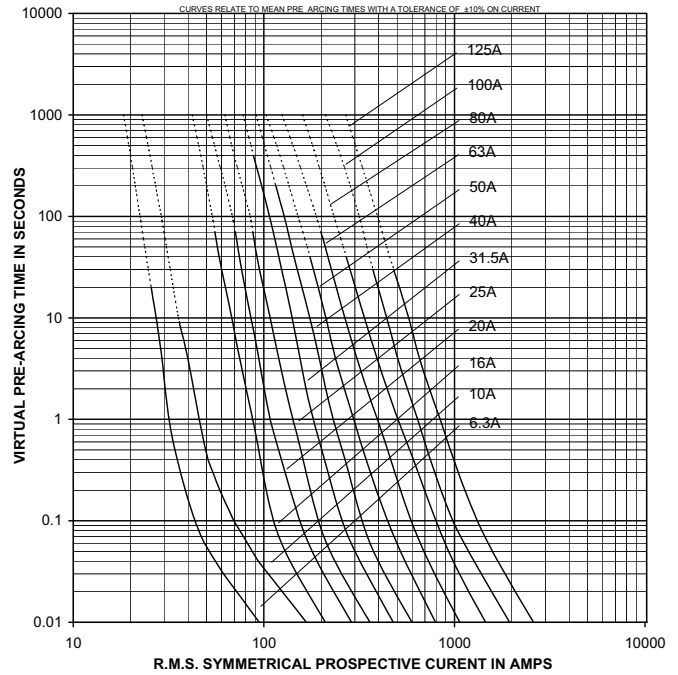

FUSE TYPES: TFL
TIME-CURRENT CHARACTERISTIC
FOR 17.5KV FUSE-LINKS

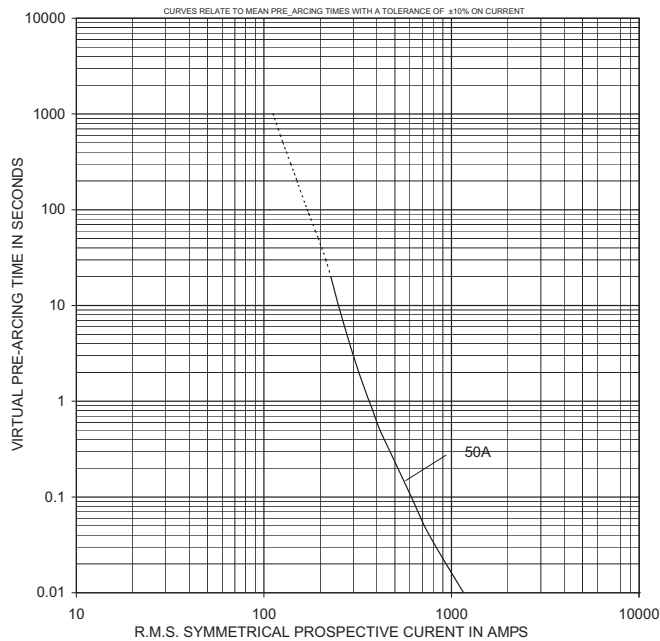

Average Time-Current Curves

For 24-27.6kV Fuses: • 24TDMEJ • 24TXMEJ
 • 24THMEJ
 • 24TFMEJ

FUSE TYPES: TDM/THM/TFM
 TIME-CURRENT CHARACTERISTIC
 FOR 24kV FUSE-LINKS

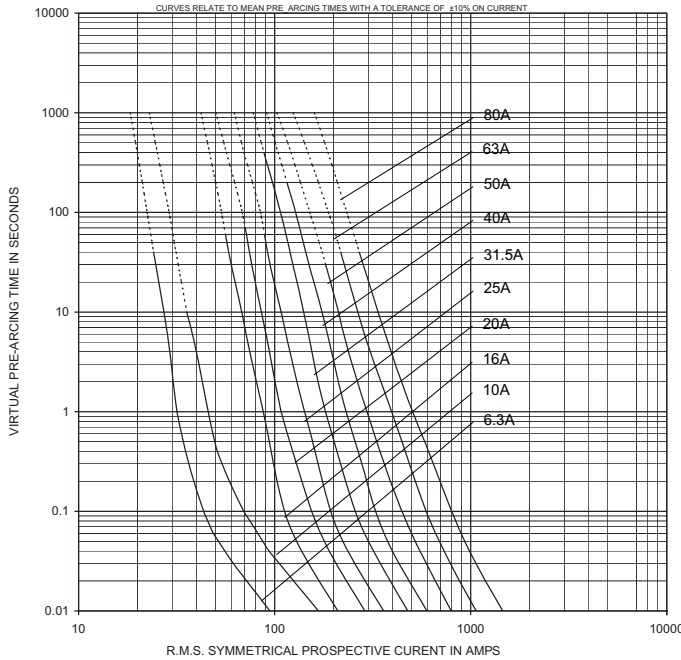

DIN Fuseclips

Suitable for use with all DIN HV fuses having 45mm end fittings.

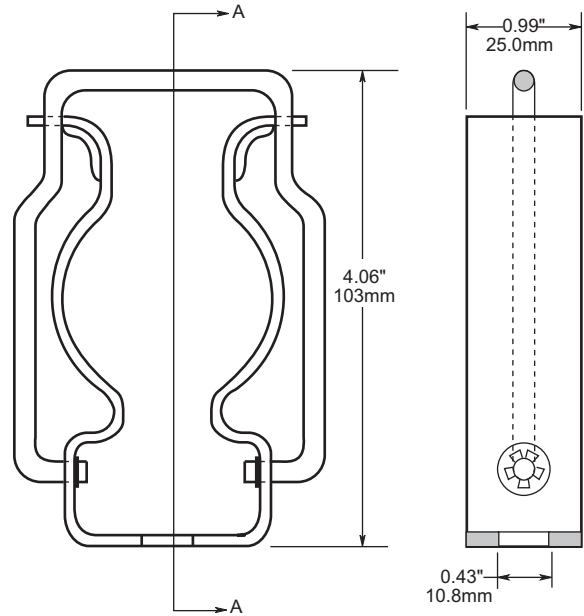

Part No. 270303
 For Standard Duty (up to 200A)

FUSE TYPES: TFM / TXM
 TIME-CURRENT CHARACTERISTIC
 FOR 24kV FUSE-LINKS

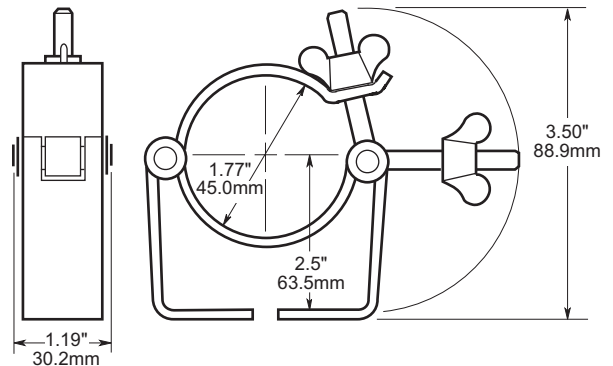
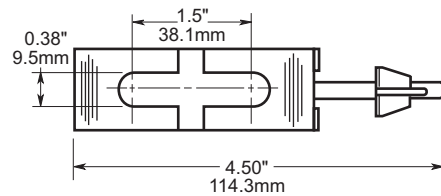
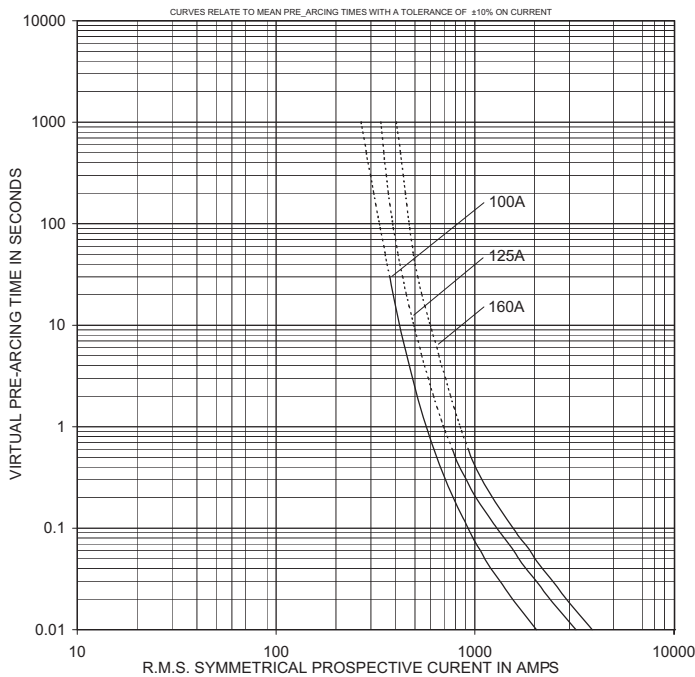

Part No. A3354745
 Heavy Duty

UL/CSA Fuses
 Current Limiting

UL/CSA Fuses
 General Purpose

Special
 Purpose Fuses

Canadian
 Fuses & Holders

Medium
 Voltage Fuses

Fuse Blocks,
 Holders & Misc.

Application
 Section

General Guide to the Selection of Fuses.

For use in the Primary Circuit of Three-Phase Transformers

Transformer 3-ph kVA	Fuse Reference and Rating in Amps														
	Fuse kV	3.6kV			7.2kV			12kV			17.5kV			24kV	
System kV	2.4kV	4.16kV	6.9kV	10kV	12.47kV	13.2kV	13.8kV	15.5kV	20kV	24kV					
25	ADLSJ 16	TDLSJ 10	TDLSJ 6.3	TDLEJ 6.3	TDMEJ 6.3	TDMEJ 6.3	TDMEJ 6.3	TDMEJ 6.3	TDMEJ 6.3	TDMEJ 6.3					
30	ADLSJ 16	TDLSJ 10	TDLSJ 6.3	TDLEJ 6.3	TDMEJ 6.3	TDMEJ 6.3	TDMEJ 6.3	TDMEJ 6.3	TDMEJ 6.3	TDMEJ 6.3					
40	ADLSJ 20	TDLSJ 16	TDLSJ 10	TDLEJ 6.3	TDMEJ 6.3	TDMEJ 6.3	TDMEJ 6.3	TDMEJ 6.3	TDMEJ 6.3	TDMEJ 6.3					
45	ADLSJ 20	TDLSJ 16	TDLSJ 10	TDLEJ 6.3	TDMEJ 6.3	TDMEJ 6.3	TDMEJ 6.3	TDMEJ 6.3	TDMEJ 6.3	TDMEJ 6.3					
63	ADLSJ 31.5	TDLSJ 20	TDLSJ 16	TDLEJ 10	TDMEJ 10	TDMEJ 10	TDMEJ 6.3	TDMEJ 6.3	TDMEJ 6.3	TDMEJ 6.3					
75	ADLSJ 40	TDLSJ 25	TDLSJ 16	TDLEJ 10	TDMEJ 10	TDMEJ 10	TDMEJ 10	TDMEJ 10	TDMEJ 10	TDMEJ 6.3					
100	ADLSJ 40	TDLSJ 25	TDLSJ 20	TDLEJ 10	TDMEJ 10	TDMEJ 10	TDMEJ 10	TDMEJ 10	TDMEJ 10	TDMEJ 10					
112	ADLSJ 40	TDLSJ 31.5	TDLSJ 20	TDLEJ 16	TDMEJ 10	TDMEJ 10	TDMEJ 10	TDMEJ 10	TDMEJ 10	TDMEJ 10					
125	WDLSJ 50	TDLSJ 31.5	TDLSJ 25	TDLEJ 16	TDMEJ 10	TDMEJ 10	TDMEJ 10	TDMEJ 10	TDMEJ 10	TDMEJ 10					
150	WDLSJ 50	TDLSJ 40	TDLSJ 25	TDLEJ 16	TDMEJ 16	TDMEJ 16	TDMEJ 16	TDMEJ 10	TDMEJ 10	TDMEJ 10					
200	WDLSJ 63	TDLSJ 50	TDLSJ 31.5	TDLEJ 20	TDMEJ 16	TDMEJ 16	TDMEJ 16	TDMEJ 16	TDMEJ 10	TDMEJ 10					
225	WDLSJ 80	TDLSJ 50	TDLSJ 40	TDLEJ 20	TDMEJ 16	TDMEJ 16	TDMEJ 16	TDMEJ 16	TDMEJ 10	TDMEJ 10					
300	WDLSJ 100	TDLSJ 63	TDLSJ 40	TDLEJ 25	TDMEJ 20	TDMEJ 20	TDMEJ 20	TDMEJ 20	TDMEJ 16	TDMEJ 10					
400	WDLSJ 125	TDLSJ 80	TDLSJ 50	TDLEJ 31.5	TDMEJ 31.5	TDMEJ 25	TDMEJ 25	TDMEJ 20	TDMEJ 20	TDMEJ 20					
450	WFLSJ 160	TFLSJ 80	TDLSJ 63	TDLEJ 40	TDMEJ 31.5	TDMEJ 31.5	TDMEJ 31.5	TDMEJ 25	TDMEJ 20	TDMEJ 20					
500	WFLSJ 160	TFLSJ 100	TDLSJ 63	TDLEJ 40	TDMEJ 31.5	TDMEJ 31.5	TDMEJ 31.5	TDMEJ 31.5	TDMEJ 25	TDMEJ 20					
600	WFLSJ 200	TFLSJ 125	TFLSJ 80	TDLEJ 50	TDMEJ 40	TDMEJ 40	TDMEJ 40	TDMEJ 31.5	TDMEJ 25	TDMEJ 20					
750	WKLSJ 250	TFLSJ 160	TFLSJ 80	TDLEJ 63	TDMEJ 50	TDMEJ 50	TDMEJ 40	TDMEJ 40	TDMEJ 31.5	TDMEJ 25					
1000	WKLSJ 315	WKMSJ 200	TFLSJ 125	THLEJ 80	TDMEJ 63	TDMEJ 63	TDMEJ 63	TDMEJ 50	TDMEJ 40	TDMEJ 31.5					
1250	WKLSJ 400	WKMSJ 250	TSFLSJ 160	THLEJ 100	TDMEJ 80	TDMEJ 80	TDMEJ 80	TDMEJ 63	TDMEJ 50	TDMEJ 40					
1500	-	WKMSJ 315	TFLSJ 160	TKLEJ 125	TDMEJ 100	TDMEJ 100	TDMEJ 80	TDMEJ 80	THMEJ 63	TDMEJ 50					
2000	-	-	WKMSJ 250	-	TKMEJ 125	TKMEJ 125	TKMEJ 125	TDMEJ 100	-	-					
2500	-	-	WKMSJ 315	-	-	-	-	TKMEJ 125	-	-					

Selection of these fuses has been based on a compromise between the following:

1. The fuse should withstand transformer magnetizing inrush currents, taken as 12 times full load current for 0.1 second.
2. The fuse should coordinate with the highest rating of the secondary fuse likely to be used.
3. The fuse should operate reasonably quickly in the event of a transformer inter-turn fault or a fault in the secondary terminal zone of the transformer.

NOTES:

- A. In general, the recommendations apply equally to the use of fuse in open air or in an encapsulated enclosure, since "1" and "2" above dictate the use of a fuse current rating sufficiently above the transformer current rating to nullify any adverse thermal affect of encapsulation. However, if the transformer is subjected to long time overcurrents, a higher rate of fuse may be required.
- B. The above recommendations are not generally applicable to transformers feeding motor circuits with starting currents in excess of the rated current of the fuse. In this event, please consult your local Edison representative.
- C. Recommendations for other voltages are available on request.
- D. While the above recommendations give a good general guide, recommendations for specific cases will be sent on receipt of full details of the application.