

APT1001R6BN 1000V 8.0A 1.60Ω

POWER MOS IV®

N-CHANNEL ENHANCEMENT MODE HIGH VOLTAGE POWER MOSFETS

MAXIMUM RATINGS

All Ratings: $T_C = 25^\circ\text{C}$ unless otherwise specified.

Symbol	Parameter	APT 1001R6BN	UNIT
V_{DSS}	Drain-Source Voltage	1000	Volts
I_D	Continuous Drain Current @ $T_C = 25^\circ\text{C}$	8	Amps
I_{DM}	Pulsed Drain Current ^①	32	
V_{GS}	Gate-Source Voltage	± 30	Volts
P_D	Total Power Dissipation @ $T_C = 25^\circ\text{C}$	240	Watts
	Linear Derating Factor	1.96	W/°C
T_J, T_{STG}	Operating and Storage Junction Temperature Range	-55 to 150	°C
T_L	Lead Temperature: 0.063" from Case for 10 Sec.	300	

STATIC ELECTRICAL CHARACTERISTICS

Symbol	Characteristic / Test Conditions / Part Number	MIN	TYP	MAX	UNIT
BV_{DSS}	Drain-Source Breakdown Voltage ($V_{GS} = 0V, I_D = 250 \mu\text{A}$)	APT1001R6BN	1000		Volts
$I_{D(ON)}$	On State Drain Current ^② ($V_{DS} > I_{D(ON)} \times R_{DS(ON)}$ Max, $V_{GS} = 10V$)	APT1002RBN	8		Amps
$R_{DS(ON)}$	Drain-Source On-State Resistance ^② ($V_{GS} = 10V, 0.5 I_D$ [Cont.])	APT1001R6BN		1.60	Ohms
I_{DSS}	Zero Gate Voltage Drain Current ($V_{DS} = V_{DSS}, V_{GS} = 0V$)			250	μA
	Zero Gate Voltage Drain Current ($V_{DS} = 0.8 V_{DSS}, V_{GS} = 0V, T_C = 125^\circ\text{C}$)			1000	
I_{GSS}	Gate-Source Leakage Current ($V_{GS} = \pm 30V, V_{DS} = 0V$)			± 100	nA
$V_{GS(TH)}$	Gate Threshold Voltage ($V_{DS} = V_{GS}, I_D = 1.0\text{mA}$)	2		4	Volts

THERMAL CHARACTERISTICS

Symbol	Characteristic	MIN	TYP	MAX	UNIT
$R_{\theta JC}$	Junction to Case			0.51	°C/W
$R_{\theta JA}$	Junction to Ambient			40	

CAUTION: These Devices are Sensitive to Electrostatic Discharge. Proper Handling Procedures Should Be Followed.

USA

405 S.W. Columbia Street

EUROPE

Avenue J.F. Kennedy Bât B4 Parc Cadéra Nord

Bend, Oregon 97702-1035

F-33700 Merignac - France

Phone: (541) 382-8028

Phone: (33) 5 57 92 15 15

FAX: (541) 388-0364

FAX: (33) 5 56 47 97 61

DYNAMIC CHARACTERISTICS

APT1001R6BN

Symbol	Characteristic	Test Conditions	MIN	TYP	MAX	UNIT
C_{iss}	Input Capacitance	$V_{GS} = 0V$ $V_{DS} = 25V$ $f = 1\text{ MHz}$		1530	1800	pF
C_{oss}	Output Capacitance			230	325	
C_{rss}	Reverse Transfer Capacitance			80	120	
Q_g	Total Gate Charge ③	$V_{GS} = 10V$ $V_{DD} = 0.5 V_{DSS}$ $I_D = I_D [\text{Cont.}] @ 25^\circ\text{C}$		66	105	nC
Q_{gs}	Gate-Source Charge			6.5	10	
Q_{gd}	Gate-Drain ("Miller") Charge			36	54	
$t_d(\text{on})$	Turn-on Delay Time	$V_{GS} = 15V$ $V_{DD} = 0.5 V_{DSS}$ $I_D = I_D [\text{Cont.}] @ 25^\circ\text{C}$ $R_G = 1.8\Omega$		14	28	ns
t_r	Rise Time			13	26	
$t_d(\text{off})$	Turn-off Delay Time			55	82	
t_f	Fall Time			19	37	

SOURCE-DRAIN DIODE RATINGS AND CHARACTERISTICS

Symbol	Characteristic / Test Conditions / Part Number	MIN	TYP	MAX	UNIT
I_S	Continuous Source Current (Body Diode)	APT1001R6BN		8	Amps
I_{SM}	Pulsed Source Current ① (Body Diode)	APT1001R6BN		32	Amps
V_{SD}	Diode Forward Voltage ② ($V_{GS} = 0V, I_S = -I_D [\text{Cont.}]$)			1.3	Volts
t_{rr}	Reverse Recovery Time ($I_S = -I_D [\text{Cont.}], di_S/dt = 100A/\mu s$)		450	910	ns
Q_{rr}	Reverse Recovery Charge ($I_S = -I_D [\text{Cont.}], di_S/dt = 100A/\mu s$)		2.5	5	μC

SAFE OPERATING AREA CHARACTERISTICS

Symbol	Characteristic	Test Conditions / Part Number	MIN	TYP	MAX	UNIT
SOA1	Safe Operating Area	$V_{DS} = 0.4 V_{DSS}, I_{DS} = P_D / 0.4 V_{DSS}, t = 1\text{ Sec.}$	240			Watts
SOA2	Safe Operating Area	$I_{DS} = I_D [\text{Cont.}], V_{DS} = P_D / I_D [\text{Cont.}], t = 1\text{ Sec.}$	240			
I_{LM}	Inductive Current Clamped	APT1001R6BN	32			Amps

① Repetitive Rating: Pulse width limited by maximum junction temperature. See Transient Thermal Impedance Curve. (Fig.1)

② Pulse Test: Pulse width < 380 μs , Duty Cycle < 2%

③ See MIL-STD-750 Method 3471

APT Reserves the right to change, without notice, the specifications and information contained herein.

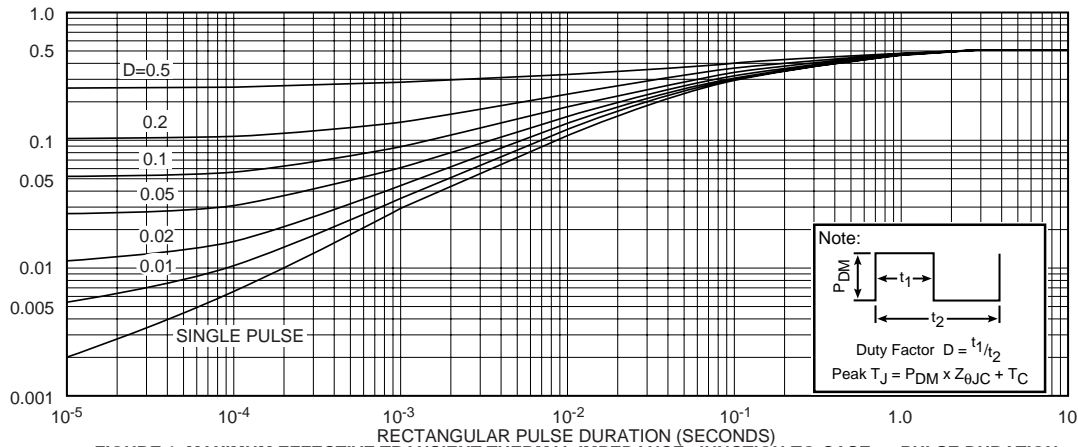

FIGURE 1, MAXIMUM EFFECTIVE TRANSIENT THERMAL IMPEDANCE, JUNCTION-TO-CASE vs PULSE DURATION

APT1001R6BN

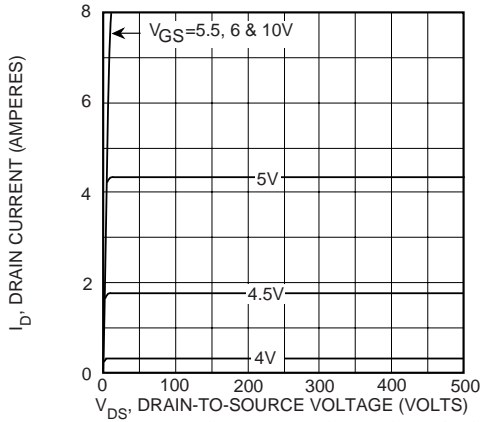

FIGURE 2, TYPICAL OUTPUT CHARACTERISTICS

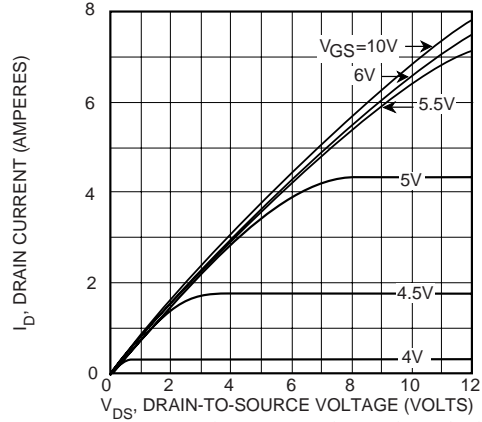

FIGURE 3, TYPICAL OUTPUT CHARACTERISTICS

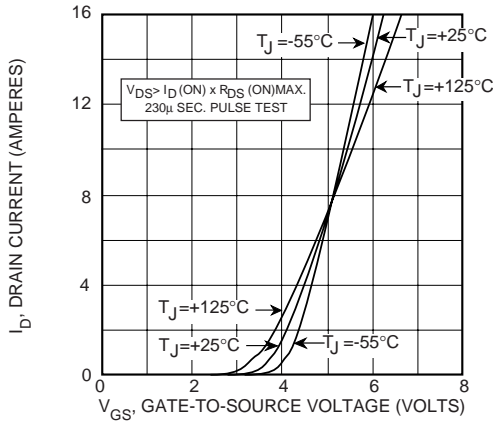

FIGURE 4, TYPICAL TRANSFER CHARACTERISTICS

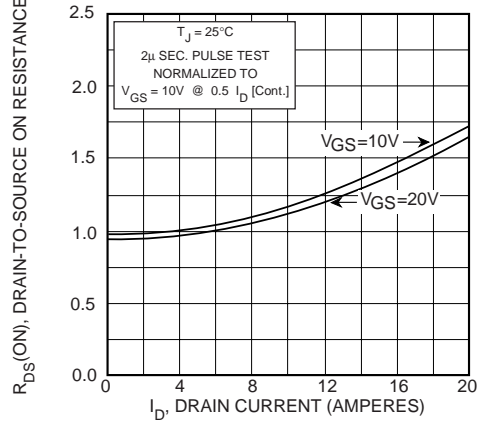

FIGURE 5, $R_{DS(ON)}$ vs DRAIN CURRENT

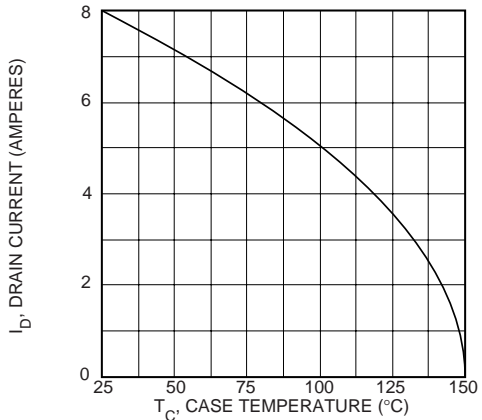

FIGURE 6, MAXIMUM DRAIN CURRENT vs CASE TEMPERATURE

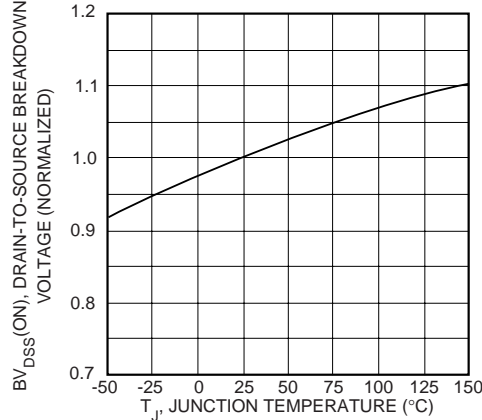

FIGURE 7, BREAKDOWN VOLTAGE vs TEMPERATURE

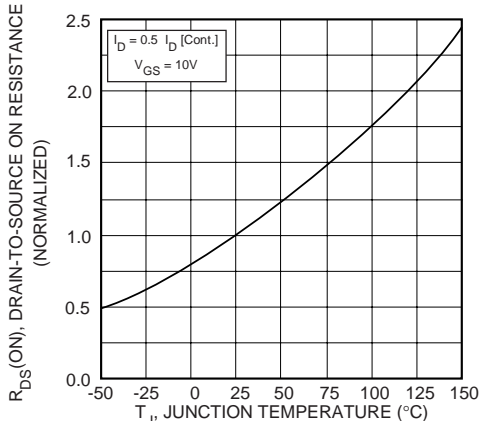

FIGURE 8, ON-RESISTANCE vs. TEMPERATURE

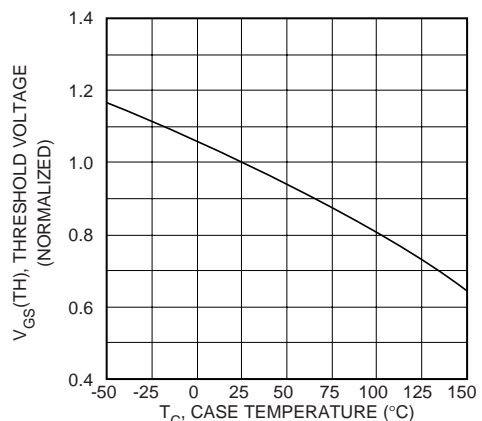

FIGURE 9, THRESHOLD VOLTAGE vs TEMPERATURE

APT1001R6BN

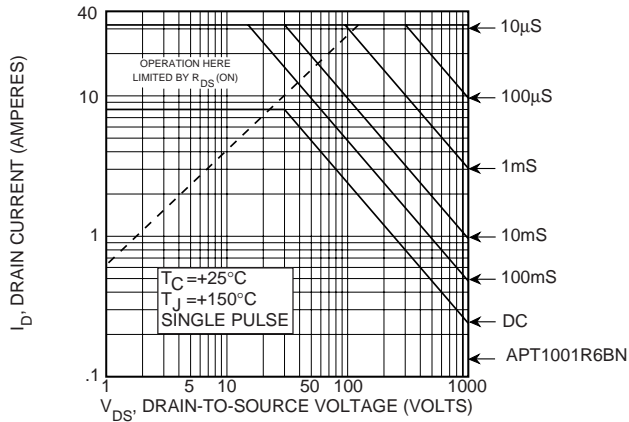

FIGURE 10, MAXIMUM SAFE OPERATING AREA

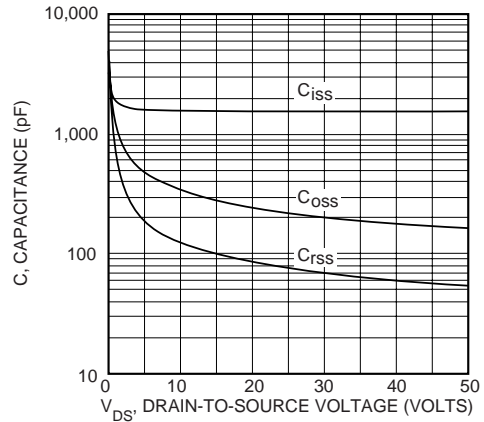

FIGURE 11, TYPICAL CAPACITANCE vs DRAIN-TO-SOURCE VOLTAGE

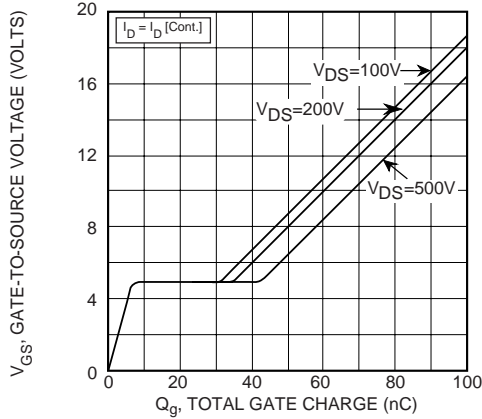

FIGURE 12, GATE CHARGES vs GATE-TO-SOURCE VOLTAGE

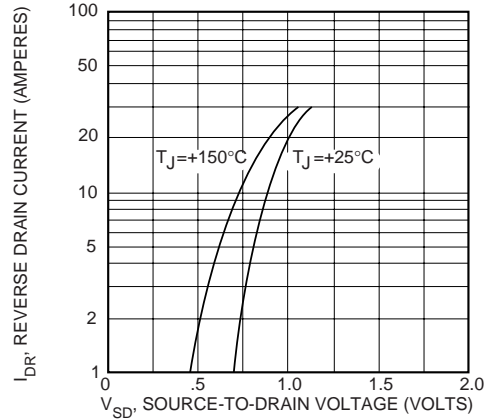
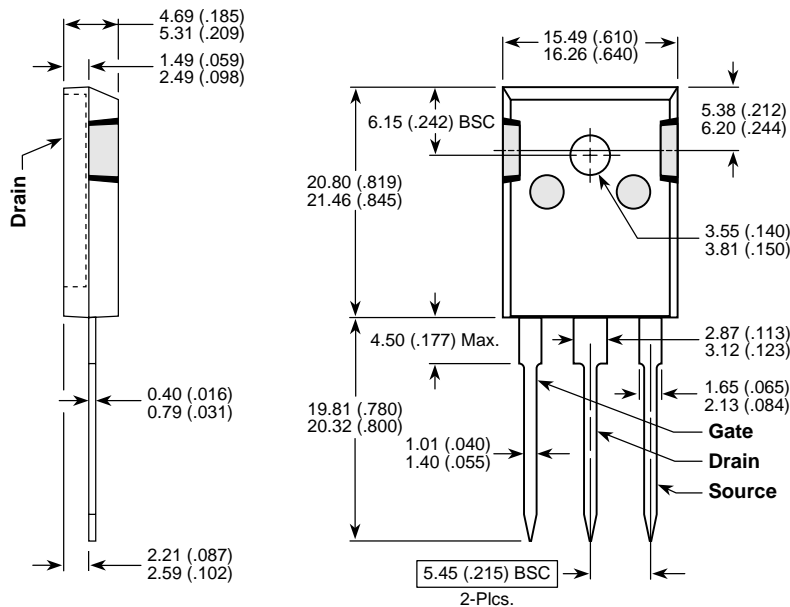

FIGURE 13, TYPICAL SOURCE-DRAIN DIODE FORWARD VOLTAGE

TO-247AD Package Outline



Dimensions in Millimeters and (Inches)