

Maximum Ratings

Symbol	Conditions	Values	Units
V_{CEVsus}	$I_C = 1\text{ A}, V_{BE} = -2\text{ V}$	1200	V
V_{CEV}	$V_{BE} = -2\text{ V}$	1200	V
V_{CBO}	$I_E = 0$	1200	V
V_{EBO}	$I_C = 0$	7	V
I_C	D. C.	100	A
I_{CM}	$t_p = 1\text{ ms}$	200	A
$I_F = -I_C$		100	A
I_B		5	A
P_{tot}	$T_{case} = 25\text{ °C}$; per darlington	800	W
T_{vj}		-40 ... +150	°C
T_{stg}		-40 ... +125	°C
V_{isol}	a. c. 50 Hz, r.m.s.	2500~	V

Thermal Characteristics

R_{thjc}	per darlington/per module	0,155/0,077	°C/W
R_{thjc}	per diode/per module	0,65/0,325	°C/W
R_{thch}	per 1/2 module/per module	0,075/0,038	°C/W

Electrical Characteristics¹⁾

		min.	typ.	max.	
I_{CEV}	$V_{CE} = V_{CEV}, V_{BE} = -2\text{ V}$			2	mA
I_{EBO}	$I_C = 0, V_{BE} = -7\text{ V}$			400	mA
$V_{CEsat}^{2)}$	$I_C = 100\text{ A}, I_B = 2\text{ A}$			3	V
$V_{BEsat}^{2)}$	$I_C = 100\text{ A}, I_B = 2\text{ A}$			3,5	V
$h_{21E}^{2)}$	$I_C = 100\text{ A}$ $V_{CE} = 5\text{ V}$	75			

Switching Characteristics for Resistive Load¹⁾

t_{on}	$I_C = 100\text{ A}$ $I_{B1} = -I_{B2} = 2\text{ A}$ $V_{CC} = 600\text{ V}$			3	µs
t_s				15	µs
t_r				3	µs

Inverse Diode Characteristics¹⁾

$V_F = -V_{CE}$	$I_F = -I_C = 100\text{ A}$			1,8	V
$I_{FSM} = -I_{Cp}$	sin 180°, 10 ms	1000			A
I_{RM}	$I_F = -I_C = 100\text{ A}, -di_F/dt = 100\text{ A}/\mu\text{s}$ $V_{BE} = -3\text{ V}, V_R = V_{CE} = 400\text{ V},$ $T_{vj} = 125\text{ °C}$			38	A
Q_{rr}				19	µC

Mechanical Data

M_1	Case to heatsink	SI units	3		6	Nm
		US units	27		53	lb. in.
M_2	Busbars to terminals	SI units	2,5		5	Nm
		US units	22		44	lb. in.
w			420			g
Case			D 14			

SEMITRANS® 3 NPN

Power Darlington Modules
100 A, 1200 V

SK 100 DB 120 D
SK 100 DAL 120 D

T-33-35

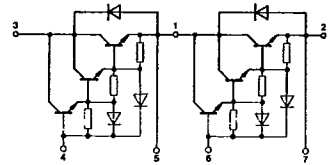
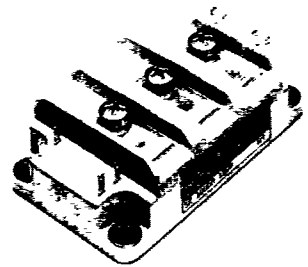

DB

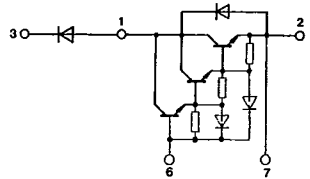

DAL

Features

- Isolated baseplate (ease of mounting of one or several modules on one heatsink)
- All electrical connections on top (ease of interconnecting of modules with busbars/PCB)
- Large clearances and creepage distances
- Parallel connected fast recovery inverse diode
- UL recognized, file no. 63 532

Typical Applications

- Switched mode power supplies
- DC servo and robot drives
- AC motor controls
- Brake choppers (DAL)

¹⁾ $T_{case} = 25\text{ °C}$ unless otherwise stated

²⁾ $t_p \leq 300\text{ µs}, D \leq 1,5\%$

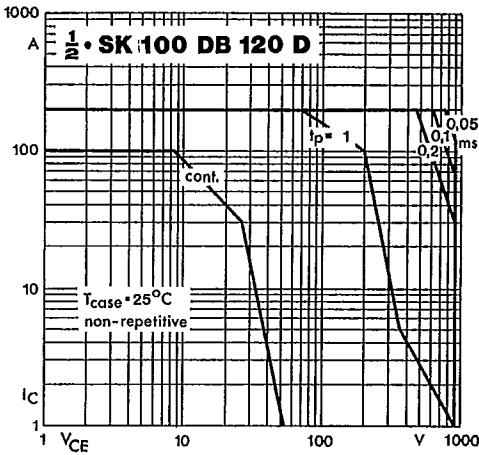

Fig. 1 Forward biased safe operating area (FBSOA)

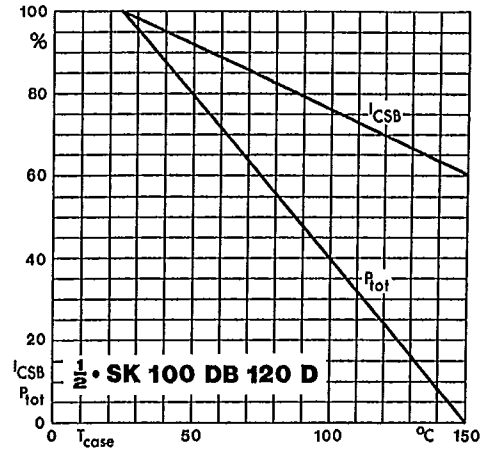

Fig. 2 Shifting the limits of the FBSOA with temperature

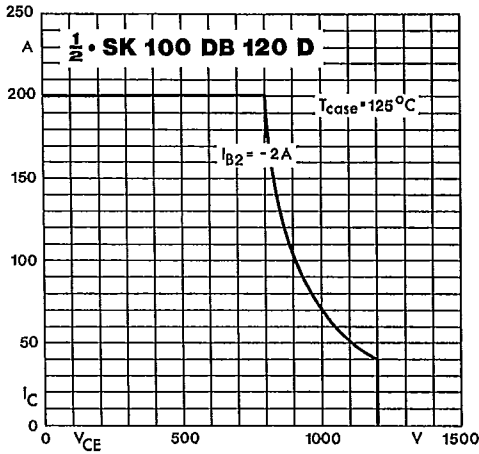

Fig. 3 Reverse biased safe operating area (RBSOA)

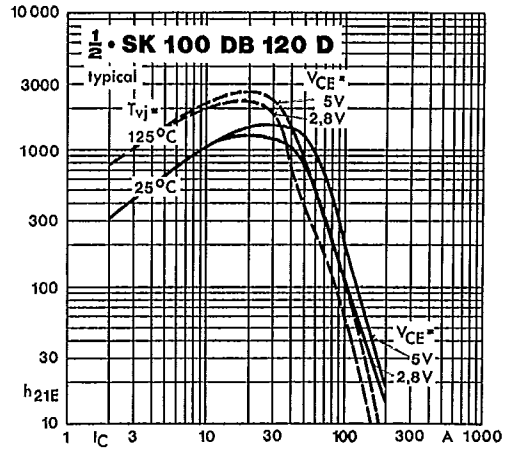

Fig. 4 Forward current transfer ratio vs. coll. current

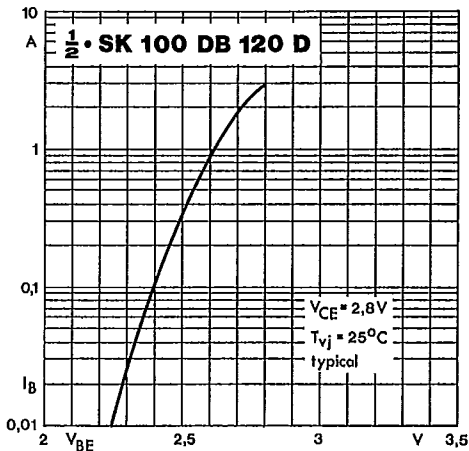

Fig. 5 Base current/voltage characteristic

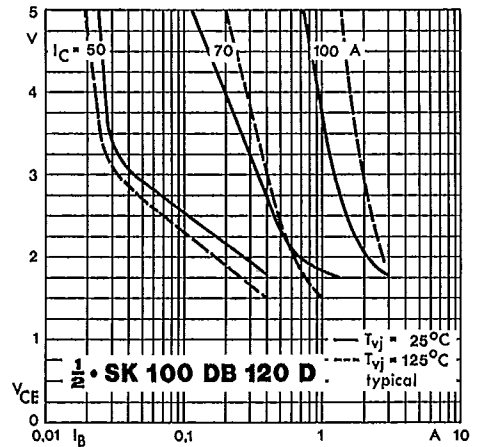
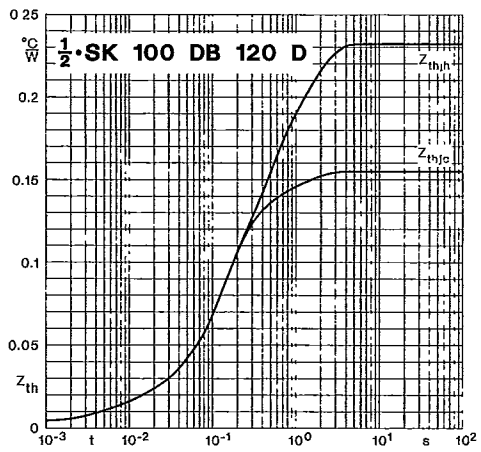
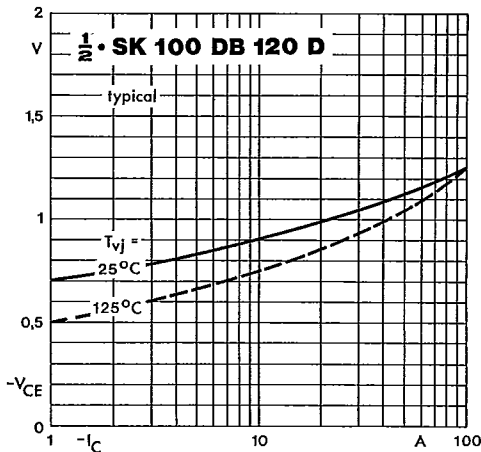
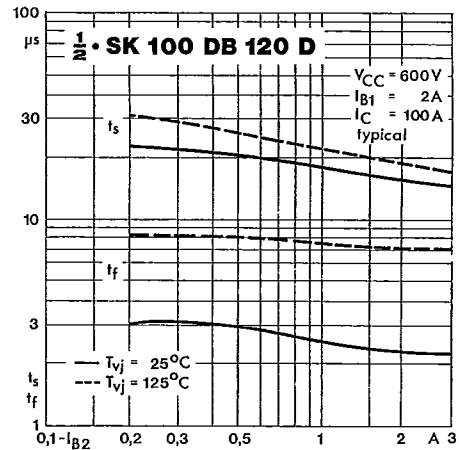
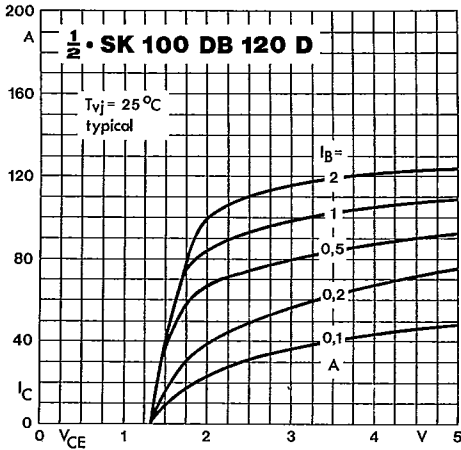
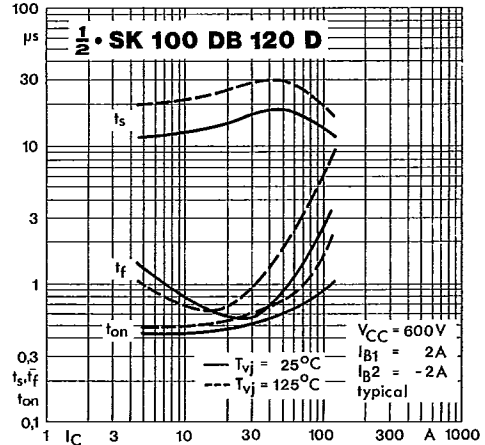
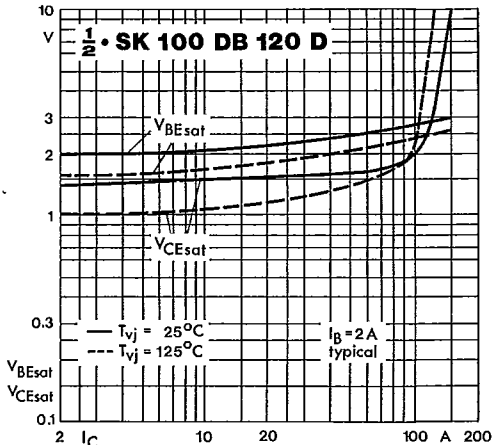

Fig. 6 Collector-emitter voltage vs. base current



SK 100 DB 120 D

SEMITRANS® 3

Case D 14

UL recognized, file no. 63 532

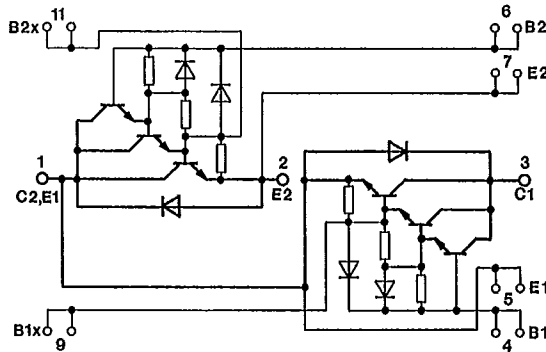
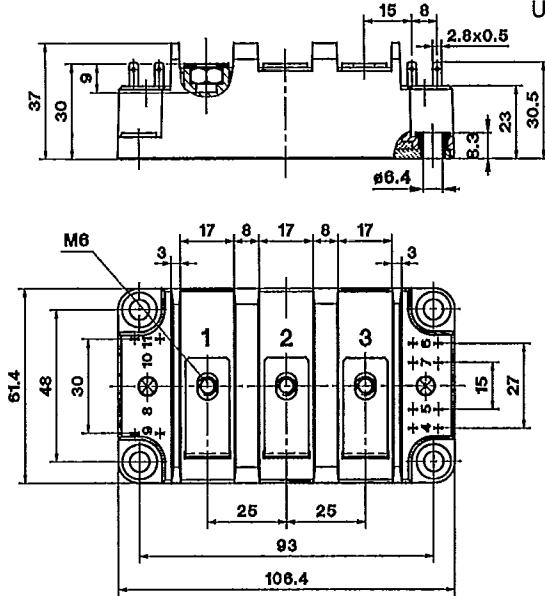

Dimensions in mm

SK 100 DAL 120 D

SEMITRANS® 3

Case D 39

UL recognized, file no. E 63 532

