

Alternistor Triacs

(6 A to 40 A)

General Description

Teccor offers bidirectional alternistors with current ratings from 6 A to 40 A and voltages from 200 V to 1000 V as part of Teccor's broad line of thyristors. Teccor's alternistor is specifically designed for applications that switch highly inductive loads. A special chip offers the same performance as two thyristors (SCRs) wired inverse parallel (back-to-back), providing better turn-off behavior than a standard triac. An alternistor may be triggered from a blocking to conduction state for either polarity of applied AC voltage with operating modes in Quadrants I, II, and III.

This new chip construction provides two electrically separate SCR structures, providing enhanced dv/dt characteristics while retaining the advantages of a single-chip device.

All alternistors have glass-passivated junctions to ensure long-term reliability and parameter stability. Teccor's glass-passivated junctions offer a reliable barrier against junction contamination.

Teccor's TO-218X package is designed for heavy, steady power-handling capability. It features large eyelet terminals for ease of soldering heavy gauge hook-up wire. All the isolated packages have a standard isolation voltage rating of 2500 V rms.

Variations of devices covered in this data sheet are available for custom design applications. Consult the factory for further information.

Features

- High surge current capability
- Glass-passivated junctions
- 2500 V ac isolation for L, J, and K Packages
- High commutating dv/dt
- High static dv/dt

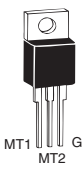
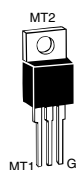
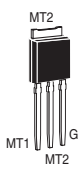
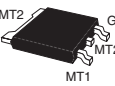
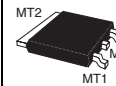
I _{T(RMS)}	Part Number					V _{DRM}	I _{GT}			I _{DRM}			
	Isolated	Non-isolated					mAmps			mAmps			
(4)(16)						(1)	(3)	(7)	(15)	(17)	(1)	(18)	
	T0-220	TO-220	TO-251 V-Pak	TO-252 D-Pak	TO-263 D²Pak	Volts	QI	QII	QIII	T _C = 25 °C	T _C = 100 °C	T _C = 125 °C	
MAX	See "Package Dimensions" section for variations. (11)					MIN	MAX			MAX			
6 A			Q2006VH3	Q2006DH3		200	10	10	10	0.01	0.5	2	
			Q4006VH3	Q4006DH3		400	10	10	10	0.01	0.5	2	
			Q6006VH3	Q6006DH3		600	10	10	10	0.01	0.5	2	
			Q8006VH3	Q8006DH3		800	10	10	10	0.01	0.5	2	
			QK006VH3	QK006DH3		1000	10	10	10	0.02	2		
			Q2006VH4	Q2006DH4		200	35	35	35	0.01	0.5	2	
			Q4006VH4	Q4006DH4		400	35	35	35	0.01	0.5	2	
			Q6006VH4	Q6006DH4		600	35	35	35	0.01	0.5	2	
			Q8006VH4	Q8006DH4		800	35	35	35	0.01	0.5	2	
			QK006VH4	QK006DH4		1000	35	35	35	0.02	2		
		Q2006LH4	Q2006RH4			Q2006NH4	200	35	35	35	0.01	0.5	2
		Q4006LH4	Q4006RH4			Q4006NH4	400	35	35	35	0.01	0.5	2
		Q6006LH4	Q6006RH4			Q6006NH4	600	35	35	35	0.01	0.5	2
	Q8006LH4	Q8006RH4			Q8006NH4	800	35	35	35	0.01	0.5	2	
	QK006LH4	QK006RH4			QK006NH4	1000	35	35	35	0.02	3		
8 A			Q2008VH3	Q2008DH3		200	10	10	10	0.01	0.5	2	
			Q4008VH3	Q4008DH3		400	10	10	10	0.01	0.5	2	
			Q6008VH3	Q6008DH3		600	10	10	10	0.01	0.5	2	
			Q8008VH3	Q8008DH3		800	10	10	10	0.01	0.5	2	
			QK008VH3	QK008DH3		1000	10	10	10	0.02	2		
			Q2008VH4	Q2008DH4		200	35	35	35	0.01	0.5	2	
			Q4008VH4	Q4008DH4		400	35	35	35	0.01	0.5	2	
			Q6008VH4	Q6008DH4		600	35	35	35	0.01	0.5	2	
			Q8008VH4	Q8008DH4		800	35	35	35	0.01	0.5	2	
			QK008VH4	QK008DH4		1000	35	35	35	0.02	2		
		Q2008LH4	Q2008RH4			Q2008NH4	200	35	35	35	0.01	0.5	2
		Q4008LH4	Q4008RH4			Q4008NH4	400	35	35	35	0.01	0.5	2
		Q6008LH4	Q6008RH4			Q6008NH4	600	35	35	35	0.01	0.5	2
	Q8008LH4	Q8008RH4			Q8008NH4	800	35	35	35	0.01	0.5	2	
	QK008LH4	QK008RH4			QK008NH4	1000	35	35	35	0.02	3		
10 A			Q2010LH5	Q2010RH5		Q2010NH5	200	50	50	50	0.01	0.5	2
			Q4010LH5	Q4010RH5		Q4010NH5	400	50	50	50	0.01	0.5	2
			Q6010LH5	Q6010RH5		Q6010NH5	600	50	50	50	0.01	0.5	2
			Q8010LH5	Q8010RH5		Q8010NH5	800	50	50	50	0.01	0.5	2
			QK010LH5	QK010RH5		QK010NH5	1000	50	50	50	0.02	3	
12 A			Q2012LH5	Q2012RH5		Q2012NH5	200	50	50	50	0.01	0.5	2
			Q4012LH5	Q4012RH5		Q4012NH5	400	50	50	50	0.01	0.5	2
			Q6012LH5	Q6012RH5		Q6012NH5	600	50	50	50	0.01	0.5	2
			Q8012LH5	Q8012RH5		Q8012NH5	800	50	50	50	0.01	0.5	2
			QK012LH5	QK012RH5		QK012NH5	1000	50	50	50	0.02	3	

See "General Notes" and "Electrical Specification Notes" on page E4 - 5.

V_{GT}	V_{TM}	I_H	I_{GTM}	P_{GM}	P_{G(AV)}	I_{TSM}	dv/dt(c)	dv/dt		t_{gt}	I²t	di/dt
(2) (6) (15) (17) (20)	(1) (5)	(1) (8) (12)	(14)	(14)		(9) (13)	(1) (4) (13)	(1)		(10)		(19)
Volts						Amps		Volts/μSec				
T _C = 25 °C	Volts	mAmps	Amps	Watts	Watts	60/50 Hz	Volts/μSec	T _C = 100 °C	T _C = 125 °C	μSec	Amps ² Sec	Amps/μSec
MAX	MAX	MAX					MIN	MIN		TYP		
1.3	1.6	15	1.6	18	0.4	65/55	20	100	75	4	17.5	70
1.3	1.6	15	1.6	18	0.4	65/55	20	100	75	4	17.5	70
1.3	1.6	15	1.6	18	0.4	65/55	20	75	50	4	17.5	70
1.3	1.6	15	1.6	18	0.4	65/55	20	50	40	4	17.5	70
1.3	1.6	15	1.6	18	0.4	65/55	20	40		4	17.5	70
1.3	1.6	35	1.6	18	0.5	65/55	25	500	400	4	17.5	70
1.3	1.6	35	1.6	18	0.5	65/55	25	500	400	4	17.5	70
1.3	1.6	35	1.6	18	0.5	65/55	25	400	300	4	17.5	70
1.3	1.6	35	1.6	18	0.5	65/55	25	300	200	4	17.5	70
1.3	1.6	35	1.6	18	0.5	65/55	25	150		4	17.5	70
1.3	1.6	35	1.6	18	0.5	85/80	25	750	600	4	30	70
1.3	1.6	35	1.6	18	0.5	85/80	25	575	450	4	30	70
1.3	1.6	35	1.6	18	0.5	85/80	25	425	350	4	30	70
1.3	1.6	35	1.6	18	0.5	85/80	25	300	250	4	30	70
1.3	1.6	35	1.6	18	0.5	85/80	25	150		4	30	70
1.3	1.6	15	1.6	18	0.4	85/80	20	100	75	4	30	70
1.3	1.6	15	1.6	18	0.4	85/80	20	100	75	4	30	70
1.3	1.6	15	1.6	18	0.4	85/80	20	75	50	4	30	70
1.3	1.6	15	1.6	18	0.4	85/80	20	50	40	4	30	70
1.3	1.6	15	1.6	18	0.4	85/80	20	40		4	30	70
1.3	1.6	35	1.6	18	0.5	85/80	25	750	400	4	30	70
1.3	1.6	35	1.6	18	0.5	85/80	25	575	450	4	30	70
1.3	1.6	35	1.6	18	0.5	85/80	25	425	350	4	30	70
1.3	1.6	35	1.6	18	0.5	85/80	25	300	250	4	30	70
1.3	1.6	35	1.6	18	0.5	85/80	25	150		4	30	70
1.3	1.6	35	2	20	0.5	100/83	25	500	400	4	41	70
1.3	1.6	35	2	20	0.5	100/83	25	500	400	4	41	70
1.3	1.6	35	2	20	0.5	100/83	25	400	300	4	41	70
1.3	1.6	35	2	20	0.5	100/83	25	300	200	4	41	70
1.3	1.6	35	2	20	0.5	100/83	25	150		4	41	70
1.3	1.6	50	2	20	0.5	120/110	30	1150	1000	4	60	70
1.3	1.6	50	2	20	0.5	120/110	30	1000	750	4	60	70
1.3	1.6	50	2	20	0.5	120/110	30	850	650	4	60	70
1.3	1.6	50	2	20	0.5	120/110	30	650	500	4	60	70
1.3	1.6	50	2	20	0.5	120/110	30	300		4	60	70
1.3	1.6	50	2	20	0.5	120/110	30	1150	1000	4	60	70
1.3	1.6	50	2	20	0.5	120/110	30	1000	750	4	60	70
1.3	1.6	50	2	20	0.5	120/110	30	850	650	4	60	70
1.3	1.6	50	2	20	0.5	120/110	30	650	500	4	60	70
1.3	1.6	50	2	20	0.5	120/110	30	300		4	60	70

See "General Notes" and "Electrical Specification Notes" on page E4 - 5.

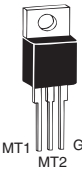
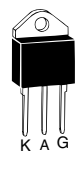
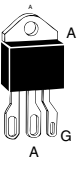
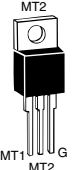
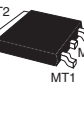
I _{T(RMS)} (4)(16)	Part Number					V _{DRM} (1)	I _{GT} (3) (7) (15) (17)		
	Isolated			Non-isolated			mAmps		
	 MT1 MT2 G TO-220	 K A G TO-218 (16)	 A K A G A TO-218X	 MT2 MT1 MT2 G TO-220	 MT2 G MT1 TO-263 D ² Pak	Volts			
MAX	See "Package Dimensions" section for variations. (11)						MAX		
16 A	Q2016LH3			Q2016RH3	Q2016NH3	200	20	20	20
	Q4016LH3			Q4016RH3	Q4016NH3	400	20	20	20
	Q6016LH3			Q6016RH3	Q6016NH3	600	20	20	20
	Q8016LH3			Q8016RH3	Q8016NH3	800	20	20	20
	QK016LH3			QK016RH3	QK016NH3	1000	20	20	20
	Q2016LH4			Q2016RH4	Q2016NH4	200	35	35	35
	Q4016LH4			Q4016RH4	Q4016NH4	400	35	35	35
	Q6016LH4			Q6016RH4	Q6016NH4	600	35	35	35
	Q8016LH4			Q8016RH4	Q8016NH4	800	35	35	35
	QK016LH4			QK016RH4	QK016NH4	1000	35	35	35
	Q2016LH6			Q2016RH6	Q2016NH6	200	80	80	80
	Q4016LH6			Q4016RH6	Q4016NH6	400	80	80	80
Q6016LH6			Q6016RH6	Q6016NH6	600	80	80	80	
Q8016LH6			Q8016RH6	Q8016NH6	800	80	80	80	
QK016LH6			QK016RH6	QK016NH6	1000	80	80	80	
25 A	Q2025L6	Q2025K6	Q2025J6	Q2025R6	Q2025NH6	200	80	80	80
	Q4025L6	Q4025K6	Q4025J6	Q4025R6	Q4025NH6	400	80	80	80
	Q6025L6	Q6025K6	Q6025J6	Q6025R6	Q6025NH6	600	80	80	80
	Q8025L6	Q8025K6	Q8025J6	Q8025R6	Q8025NH6	800	80	80	80
	QK025L6	QK025K6		QK025R6	QK025NH6	1000	80	80	80
30 A	Q2030LH5					200	50	50	50
	Q4030LH5					400	50	50	50
	Q6030LH5					600	50	50	50
35 A				Q2035RH5	Q2035NH5	200	50	50	50
				Q4035RH5	Q4035NH5	400	50	50	50
				Q6035RH5	Q6035NH5	600	50	50	50
40 A		Q2040K7	Q2040J7			200	100	100	100
		Q4040K7	Q4040J7			400	100	100	100
		Q6040K7	Q6040J7			600	100	100	100
		Q8040K7	Q8040J7			800	100	100	100
		QK040K7				1000	100	100	100

See "General Notes" and "Electrical Specification Notes" on page E4 - 5.

Test Conditions

- di/dt** — Maximum rate-of-change of on-state current
- dv/dt** — Critical rate-of-rise of off-state voltage at rated V_{DRM} gate open
- dv/dt(c)** — Critical rate-of-rise of commutation voltage at rated V_{DRM} and I_{T(RMS)} commutating di/dt = 0.54 rated I_{T(RMS)}/ms; gate unenergized
- I²t** — RMS surge (non-repetitive) on-state current for period of 8.3 ms for fusing
- I_{DRM}** — Peak off-state current gate open; V_{DRM} = maximum rated value
- I_{GT}** — DC gate trigger current in specific operating quadrants; V_D = 12 V dc
- I_{GTM}** — Peak gate trigger current

- I_H** — Holding current (DC); gate open
- I_{T(RMS)}** — RMS on-state current conduction angle of 360°
- I_{TSM}** — Peak one-cycle surge
- P_{G(AV)}** — Average gate power dissipation
- P_{GM}** — Peak gate power dissipation; I_{GT} ≤ I_{GTM}
- t_{gt}** — Gate controlled turn-on time; I_{GT} = 300 mA with 0.1 μs rise time
- V_{DRM}** — Repetitive peak blocking voltage
- V_{GT}** — DC gate trigger voltage; V_D = 12 V dc
- V_{TM}** — Peak on-state voltage at maximum rated RMS current

I _{DRM}			V _{GT}	V _{TM}	I _H	I _{GT}	P _{GM}	P _{G(AV)}	I _{TSM}	dv/dt(c)	dv/dt		t _{gt}	I ² t	di/dt
(1) (18)			(2) (6) (15) (17) (20)	(1) (5)	(1) (8) (12)	(14)	(14)		(9) (13)	(1) (4) (13)	(1)		(10)		(19)
mAmps			Volts	Volts					Amps		Volts/μSec				
T _C = 25 °C	T _C = 100 °C	T _C = 125 °C	T _C = 25 °C	T _C = 25 °C	mAmps	Amps	Watts	Watts	60/50 Hz	Volts/μSec	T _C = 100 °C	T _C = 125 °C	μSec	Amps ² Sec	Amps/μSec
MAX			MAX	MAX	MAX					MIN	MIN		TYP		
0.05	0.5	2	1.5	1.6	35	2	20	0.5	200/167	20	500	400	3	166	100
0.05	0.5	27	1.5	1.6	35	2	20	0.5	200/167	20	400	350	3	166	100
0.05	0.5	2	1.5	1.6	35	2	20	0.5	200/167	20	300	250	3	166	100
0.1	1	3	1.5	1.6	35	2	20	0.5	200/167	20	275	200	3	166	100
0.1	3		1.5	1.6	35	2	20	0.5	200/167	20	200		3	166	100
0.05	0.5	2	2	1.6	50	2	20	0.5	200/167	25	650	500	3	166	100
0.05	0.5	2	2	1.6	50	2	20	0.5	200/167	25	600	475	3	166	100
0.05	0.5	2	2	1.6	50	2	20	0.5	200/167	25	500	400	3	166	100
0.1	1	3	2	1.6	50	2	20	0.5	200/167	25	425	350	3	166	100
0.1	3		2	1.6	50	2	20	0.5	200/167	25	300		3	166	100
0.05	0.5	2	2.5	1.6	70	2	20	0.5	200/167	30	875	600	5	166	100
0.05	0.5	2	2.5	1.6	70	2	20	0.5	200/167	30	875	600	5	166	100
0.05	0.5	2	2.5	1.6	70	2	20	0.5	200/167	30	800	520	5	166	100
0.1	1	3	2.5	1.6	70	2	20	0.5	200/167	30	700	475	5	166	100
0.1	3		2.5	1.6	70	2	20	0.5	200/167	30	350		5	166	100
0.05	0.5	2	2.5	1.8	100	2	20	0.5	250/208	30	875	600	5	259	100
0.05	0.5	2	2.5	1.8	100	2	20	0.5	250/208	30	875	600	5	259	100
0.05	0.5	2	2.5	1.8	100	2	20	0.5	250/208	30	800	520	5	259	100
0.1	1	3	2.5	1.8	100	2	20	0.5	250/208	30	700	475	5	259	100
0.1	3		2.5	1.8	100	2	20	0.5	250/208	30	400		5	259	100
0.05	0.5	2	2	1.4	75	2	20	0.5	350/290	20	650	500	3	508	100
0.05	0.5	2	2	1.4	75	2	20	0.5	350/290	20	600	475	3	508	100
0.05	0.5	2	2	1.4	75	2	20	0.5	350/290	20	500	400	3	508	100
0.05	0.5	2	2	1.5	75	2	20	0.5	350/290	20	650	500	3	508	100
0.05	0.5	2	2	1.5	75	2	20	0.5	350/290	20	600	475	3	508	100
0.05	0.5	2	2	1.5	75	2	20	0.5	350/290	20	500	400	3	508	100
0.2	2	5	2.5	1.8	120	4	40	0.8	400/335	50	1100	700	5	664	150
0.2	2	5	2.5	1.8	120	4	40	0.8	400/335	50	1100	700	5	664	150
0.2	2	5	2.5	1.8	120	4	40	0.8	400/335	50	1000	625	5	664	150
0.2	2	5	2.5	1.8	120	4	40	0.8	400/335	50	900	575	5	664	150
0.2	5		2.5	1.8	120	4	40	0.8	400/335	50	500		5	664	150

General Notes

- All measurements are made at 60 Hz with a resistive load at an ambient temperature of +25 °C unless specified otherwise.
- Operating temperature range (T_J) is -40 °C to +125 °C.
- Storage temperature range (T_S) is -40 °C to +125 °C.
- Lead solder temperature is a maximum of 230 °C for 10 seconds maximum ≥1/16" (1.59 mm) from case.
- The case temperature (T_C) is measured as shown in the dimensional outline drawings. See "Package Dimensions" section.

Electrical Specification Notes

- For either polarity of MT2 with reference to MT1 terminal
- For either polarity of gate voltage (V_{GT}) with reference to MT1 terminal
- See Gate Characteristics and Definition of Quadrants.
- See Figure E4.1 through Figure E4.4 for current rating at specific operating temperature and Figure 4.16 for free air rating (no heat sink).
- See Figure E4.5 and Figure E4.6 for I_T and V_T.
- See Figure E4.7 for V_{GT} versus T_C.
- See Figure E4.8 for I_{GT} versus T_C.
- See Figure E4.9 for I_H versus T_C.
- See Figure E4.10 and Figure E4.11 for surge rating with specific durations.

- (10) See Figure E4.12 for t_{gt} versus I_{GT} .
- (11) See package outlines for lead form configurations. When ordering special lead forming, add type number as suffix to part number.
- (12) Initial on-state current = 400 mA dc for 16 A to 40 A devices and 100 mA for 6 A to 12 A devices.
- (13) See Figure E4.1 through Figure E4.4 for maximum allowable case temperature at maximum rated current.
- (14) Pulse width $\leq 10 \mu s$; $I_{GT} \leq I_{GTM}$
- (15) For 6 A to 12 A devices, $R_L = 60 \Omega$; 16 A and above, $R_L = 30 \Omega$
- (16) 40 A pin terminal leads on K package can run 100 °C to 125 °C.
- (17) Alternistor does not turn on in Quadrant IV.
- (18) $T_C = T_J$ for test conditions in off state
- (19) $I_{GT} = 200 \text{ mA}$ for 6 A to 12 A devices and 500 mA for 16 A to 40 A devices with gate pulse having rise time of $\leq 0.1 \mu s$.
- (20) Minimum non-trigger V_{GT} at 125 °C is 0.2 V.

Gate Characteristics

Teccor triacs may be turned on in the following ways:

- In-phase signals (with standard AC line) using Quadrants I and III
- Application of unipolar pulses (gate always negative), using Quadrants II and III with negative gate pulses

In all cases, if maximum surge capability is required, gate pulses should be a minimum of one magnitude above minimum I_{GT} rating with a steep rising waveform ($\leq 1 \mu s$ rise time).

If QIV and QI operation is required (gate always positive), see Figure AN1002.8, "Amplified Gate" Thyristor Circuit.

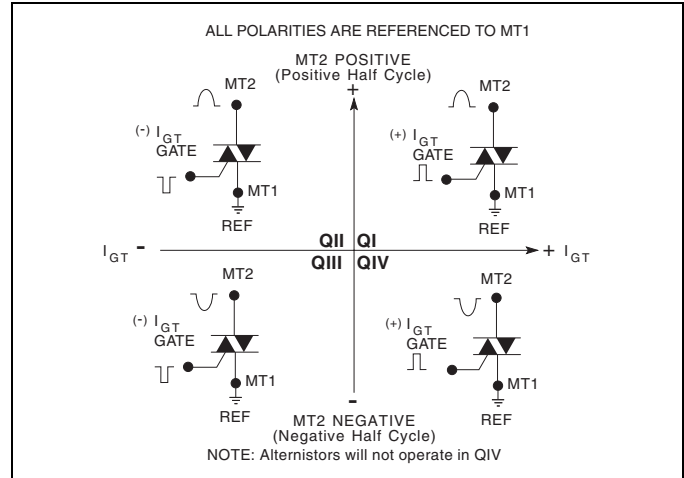

Definition of Quadrants

Electrical Isolation

Teccor's isolated alternistor packages withstand a minimum high potential test of 2500 V ac rms from leads to mounting tab, over the operating temperature range of the device. The following isolation table shows standard and optional isolation ratings.

Electrical Isolation from Leads to Mounting Tab *			
V AC RMS	TO-218 Isolated	TO-220 Isolated	TO-218X Isolated
2500	Standard	Standard	Standard
4000	N/A	Optional **	N/A

* UL Recognized File E71639

** For 4000 V isolation, use V suffix in part number.

Thermal Resistance (Steady State) $R_{\theta JC} [R_{\theta JA}]$ (TYP.) °C/W							
Package Code	K	J	L	R	D	V	N
Type	TO-218 Isolated *	TO-218X Isolated *	TO-220 Isolated **	TO-220 Non-Isolated	TO-252 D-Pak	TO-251 V-Pak	TO-263 D ² Pak
6 A			3.3 [50]	1.80 [45]	2.1	2.3 [64]	1.80
8 A			2.8	1.50	1.8	2.1	1.50
10 A			2.6	1.30			1.30
12 A			2.3	1.20			1.20
16 A			2.1	1.10			1.10
25 A	1.35	1.32	2.0	0.87			0.87
30 A			2.3				
35 A				0.85			
40 A	0.97	0.95					

* UL Recognized Product per UL File E71639

** For 4000 V isolation, use V suffix in part number.

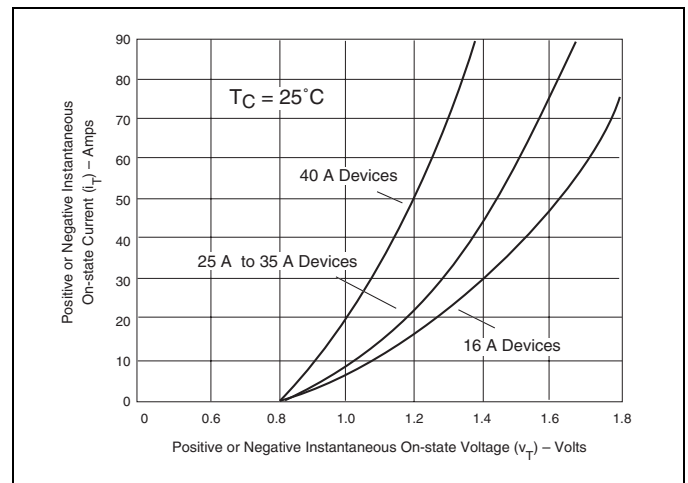
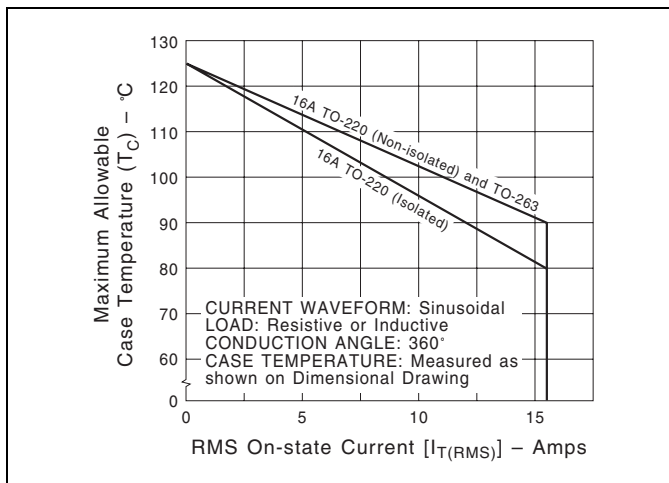
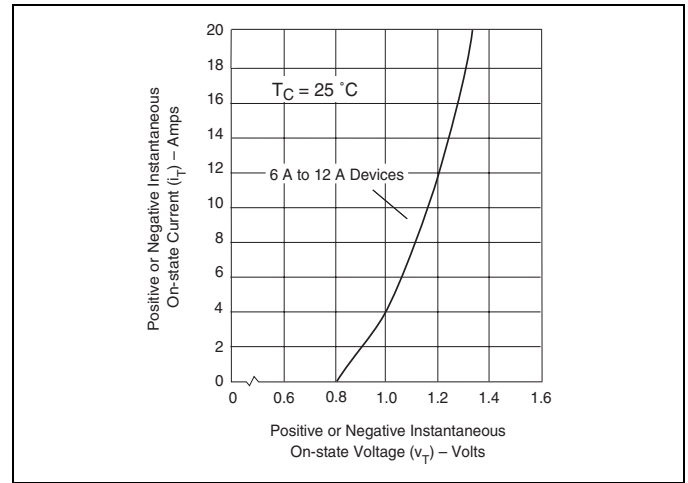
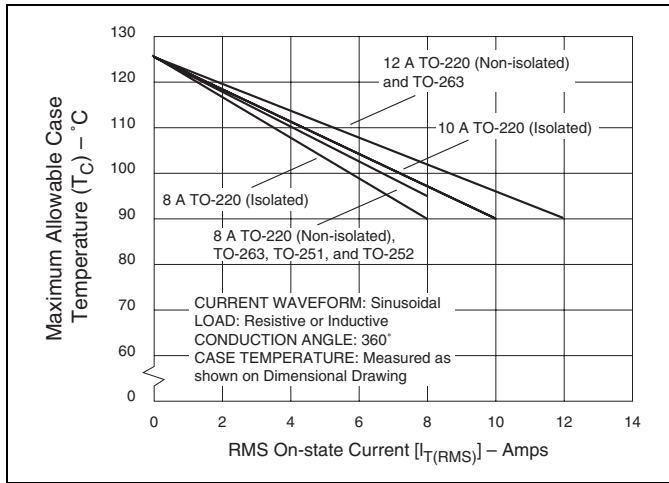
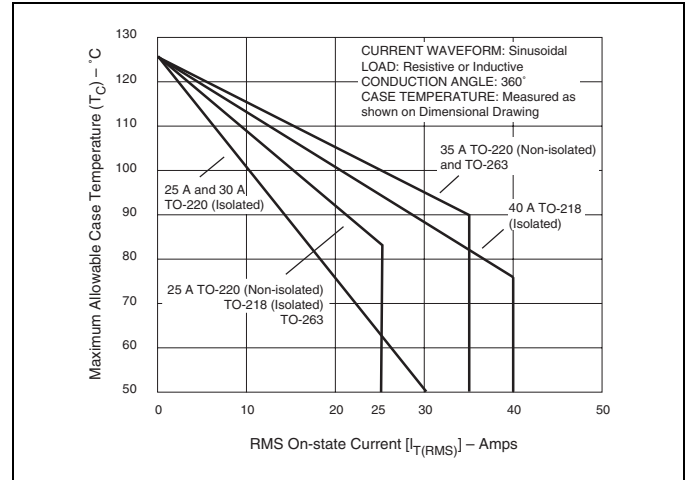
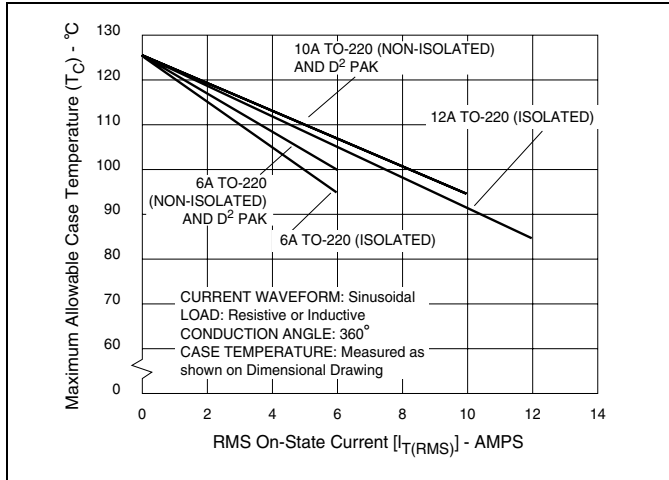

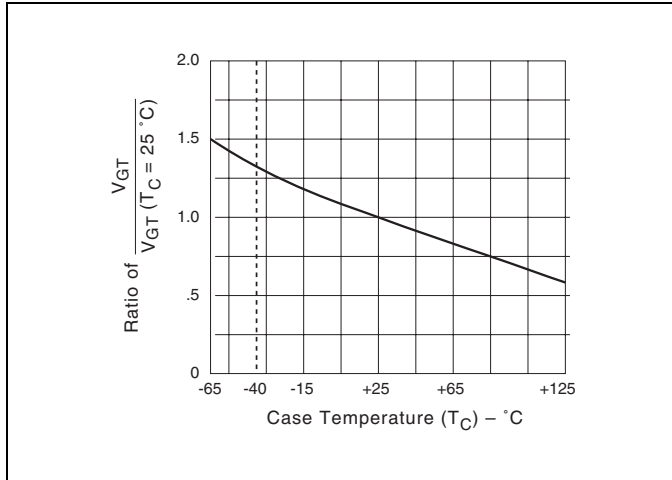

Figure E4.7 Normalized DC Gate Trigger Voltage for all Quadrants versus Case Temperature

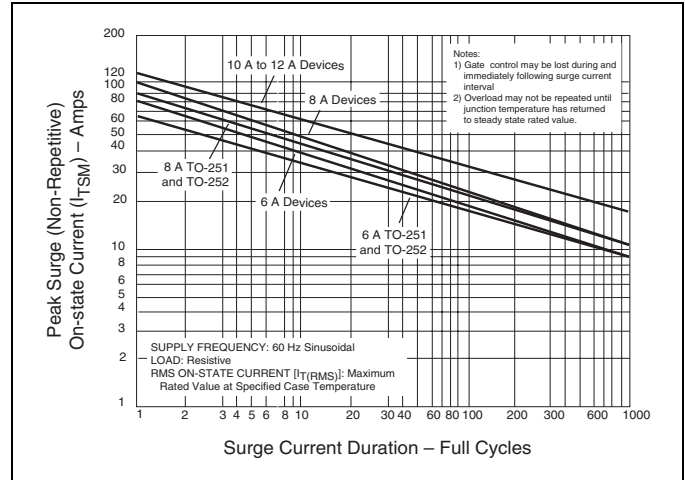

Figure E4.10 Peak Surge Current versus Surge Current Duration (6 A to 12 A)

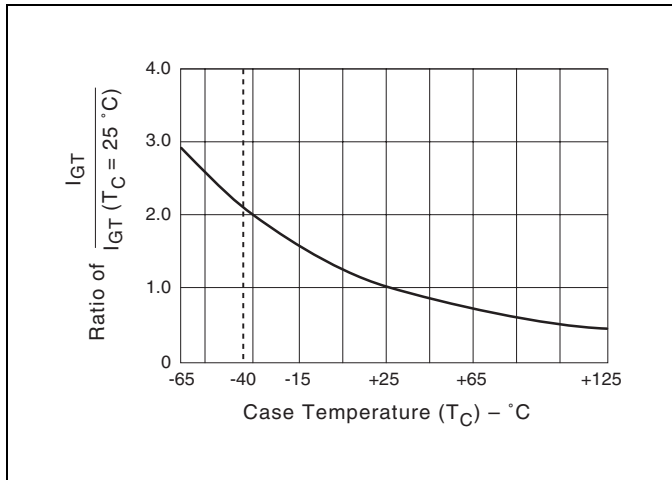

Figure E4.8 Normalized DC Gate Trigger Current for all Quadrants versus Case Temperature

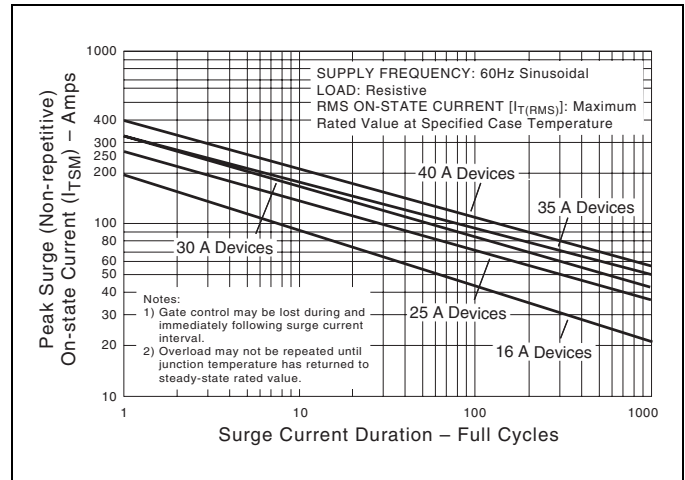

Figure E4.11 Peak Surge Current versus Surge Current Duration (16 A to 40 A)

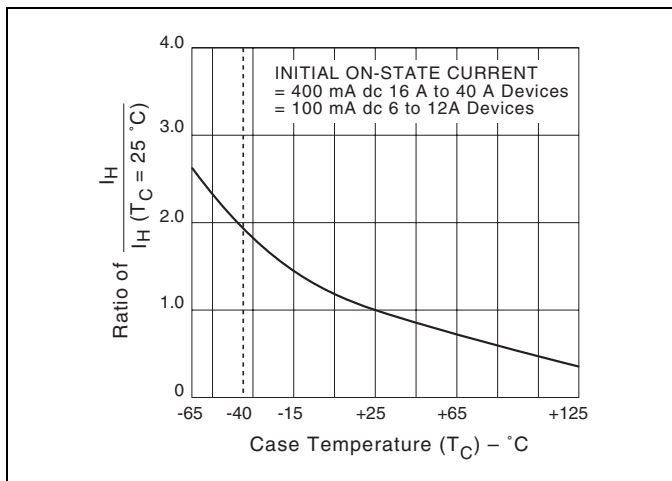

Figure E4.9 Normalized DC Holding Current versus Case Temperature

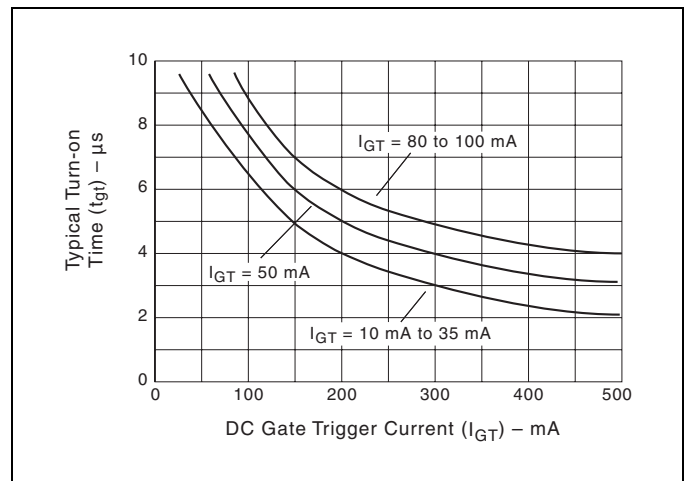

Figure E4.12 Turn-on Time versus Gate Trigger Current (Typical)

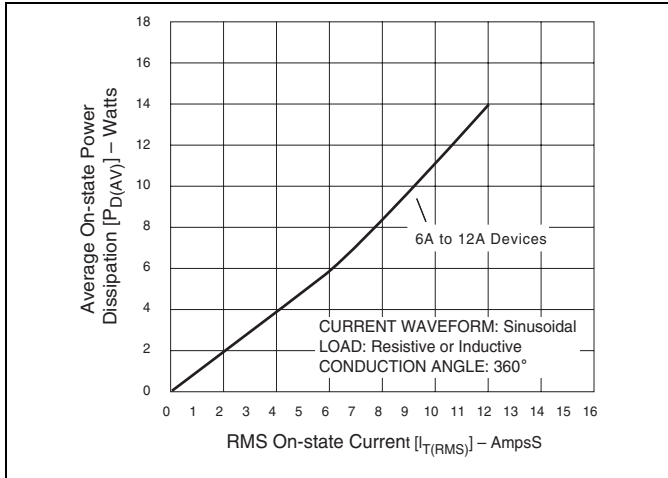

Figure E4.13 Power Dissipation (Typical) versus On-state Current (6 A to 12 A)

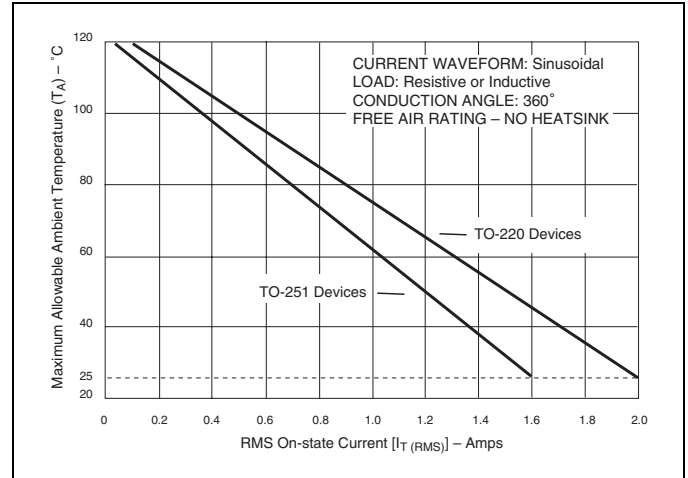

Figure E4.16 Maximum Allowable Ambient Temperature versus On-state Current

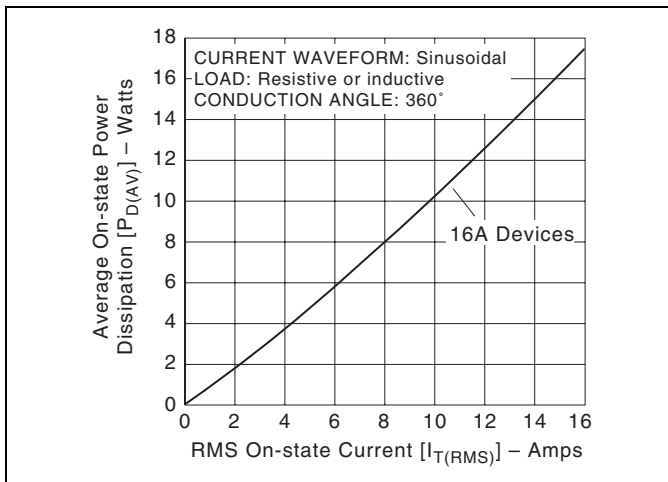

Figure E4.14 Power Dissipation (Typical) versus On-state Current (16 A)

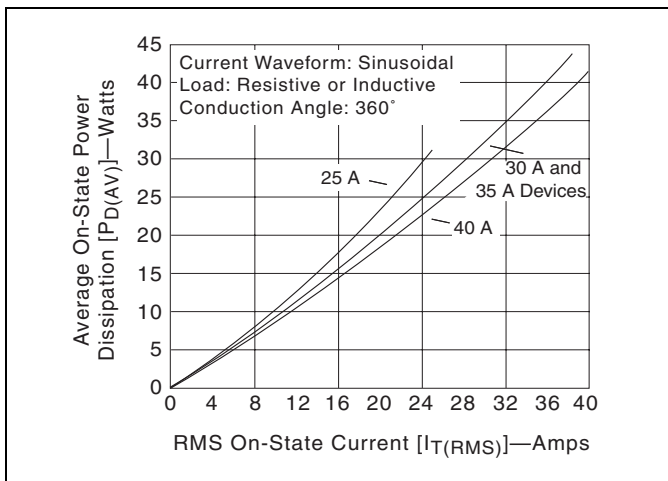

Figure E4.15 Power Dissipation (Typical) versus On-state Current (25 A to 40 A)

