

NPN Silicon Switching Transistors

PZT 2222
PZT 2222 A

- High DC current gain: 0.1 mA to 500 mA
- Low collector-emitter saturation voltage
- Complementary types: PZT 2907 (PNP)
PZT 2907 A (PNP)

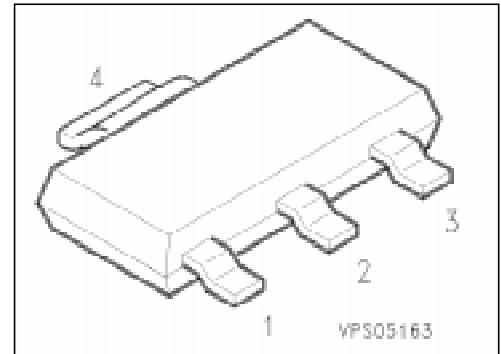

Type	Marking	Ordering Code (tape and reel)	Pin Configuration				Package ¹⁾
			1	2	3	4	
PZT 2222 PZT 2222 A	ZT 2222 ZT 2222 A	Q62702-Z2026 Q62702-Z2027	B	C	E	C	SOT-223

Maximum Ratings

Parameter	Symbol	Values		Unit
		PZT 2222	PZT 2222 A	
Collector-emitter voltage	V_{CE0}	30	40	V
Collector-base voltage	V_{CB0}	60	75	
Emitter-base voltage	V_{EB0}	5	6	
Collector current	I_C	600		mA
Total power dissipation, $T_s = 110\text{ °C}$	P_{tot}	1.5		W
Junction temperature	T_j	150		°C
Storage temperature range	T_{stg}	- 65 ... + 150		

Thermal Resistance

Junction - ambient ²⁾	$R_{th JA}$	≤ 87	K/W
Junction - soldering point	$R_{th JS}$	≤ 27	

¹⁾ For detailed information see chapter Package Outlines.

²⁾ Package mounted on epoxy pcb 40 mm × 40 mm × 1.5 mm/6 cm² Cu.

Electrical Characteristics

at $T_A = 25\text{ }^\circ\text{C}$, unless otherwise specified.

Parameter	Symbol	Values			Unit
		min.	typ.	max.	

DC characteristics

Collector-emitter breakdown voltage $I_C = 10\text{ mA}, I_B = 0$	PZT 2222 PZT 2222 A	$V_{(BR)CE0}$	30 40	— —	— —	V
Collector-base breakdown voltage $I_C = 10\text{ }\mu\text{A}, I_B = 0$	PZT 2222 PZT 2222 A	$V_{(BR)CB0}$	60 75	— —	— —	
Emitter-base breakdown voltage $I_E = 10\text{ }\mu\text{A}, I_E = 0$	PZT 2222 PZT 2222 A	$V_{(BR)EB0}$	5 6	— —	— —	
Collector-base cutoff current $V_{CB} = 50\text{ V}, I_E = 0$	PZT 2222 PZT 2222 A	I_{CB0}	—	—	20	nA
$V_{CB} = 50\text{ V}, I_E = 0, T_A = 150\text{ }^\circ\text{C}$	PZT 2222 PZT 2222 A		—	—	10	nA
	PZT 2222		—	—	20	μA
	PZT 2222 A		—	—	10	μA
Emitter-base cutoff current $V_{EB} = 3\text{ V}, I_C = 0$		I_{EB0}	—	—	10	nA
Collector-emitter cutoff current $V_{CE} = 30\text{ V}, -V_{BE} = 0.5\text{ V}$		I_{CEV}	—	—	50	
Emitter-base cutoff current $V_{CE} = 30\text{ V}, -V_{BE} = 0.5\text{ V}$		I_{EBV}	—	—	50	
DC current gain ¹⁾ $I_C = 0.1\text{ mA}, V_{CE} = 10\text{ V}$	PZT 2222 PZT 2222 A	h_{FE}	35	—	—	—
$I_C = 1\text{ mA}, V_{CE} = 10\text{ V}$			50	—	—	
$I_C = 10\text{ mA}, V_{CE} = 10\text{ V}$			75	—	—	
$I_C = 150\text{ mA}, V_{CE} = 10\text{ V}$			100	—	300	
$I_C = 500\text{ mA}, V_{CE} = 10\text{ V}$			30	—	—	
			40	—	—	

¹⁾ Pulse test conditions: $t \leq 300\text{ }\mu\text{s}, D = 2\text{ }%$.

Electrical Characteristics

at $T_A = 25\text{ }^\circ\text{C}$, unless otherwise specified.

Parameter	Symbol	Values			Unit
		min.	typ.	max.	

DC characteristics

Collector-emitter saturation voltage ¹⁾ $I_C = 150\text{ mA}$, $I_B = 15\text{ mA}$	V_{CEsat}				V
PZT 2222		–	–	0.4	
PZT 2222 A		–	–	0.3	
$I_C = 500\text{ mA}$, $I_B = 50\text{ mA}$	V_{CEsat}				
PZT 2222		–	–	1.6	
PZT 2222 A		–	–	1.0	
Base-emitter saturation voltage ¹⁾ $I_C = 150\text{ mA}$, $I_B = 15\text{ mA}$	V_{BEsat}				
PZT 2222		–	–	1.3	
PZT 2222 A		–	–	1.2	
$I_C = 500\text{ mA}$, $I_B = 50\text{ mA}$	V_{BEsat}				
PZT 2222		–	–	2.6	
PZT 2222 A		–	–	2.0	

AC characteristics

Transition frequency $I_C = 20\text{ mA}$, $V_{CE} = 20\text{ V}$, $f = 100\text{ MHz}$	f_T	200	–	–	MHz
Collector-base capacitance $V_{CB} = 10\text{ V}$, $f = 1\text{ MHz}$	C_{obo}	–	–	8	pF
Input capacitance $V_{EB} = 0.5\text{ V}$, $f = 1\text{ MHz}$	C_{ibo}	–	–	30	
$V_{CC} = 30\text{ V}$, $I_C = 150\text{ mA}$, $I_{B1} = 15\text{ mA}$					
Delay time	t_d	–	–	10	ns
Rise time	t_r	–	–	25	ns
$V_{CC} = 30\text{ V}$, $I_C = 150\text{ mA}$, $I_{B1} = I_{B2} = 15\text{ mA}$					
Storage time	t_{stg}	–	–	225	ns
Fall time (see diagrams)	t_f	–	–	60	ns

¹⁾ Pulse test conditions: $t \leq 300\text{ }\mu\text{s}$, $D = 2\text{ }\%$.

Input waveform and test circuit for determining delay, rise and turn-on time

Turn-on time when switched to $I_{Con} = 150 \text{ mA}$; $I_{Bon} = 15 \text{ mA}$

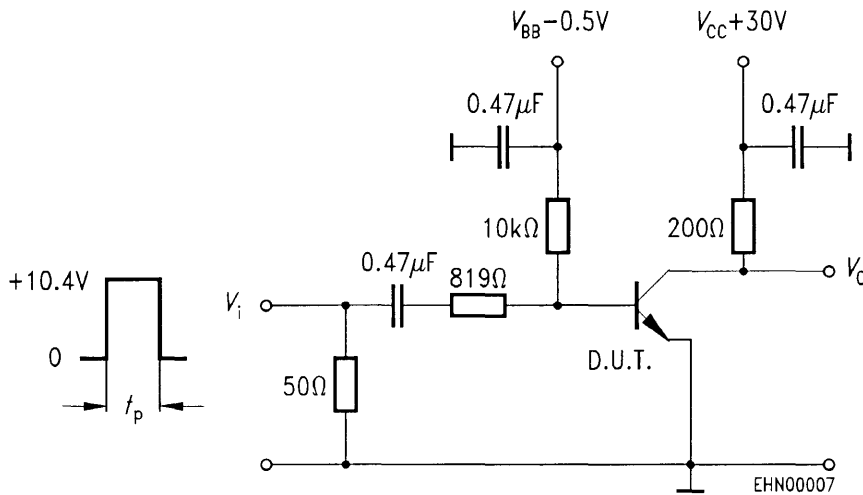

Input waveform and test circuit for determining storage, fall and turn-off time

Turn-off time when switched to $I_{Con} = 150 \text{ mA}$; $I_{Bon} = 15 \text{ mA}$ to cut-off with $-I_{Boff} = 15 \text{ mA}$

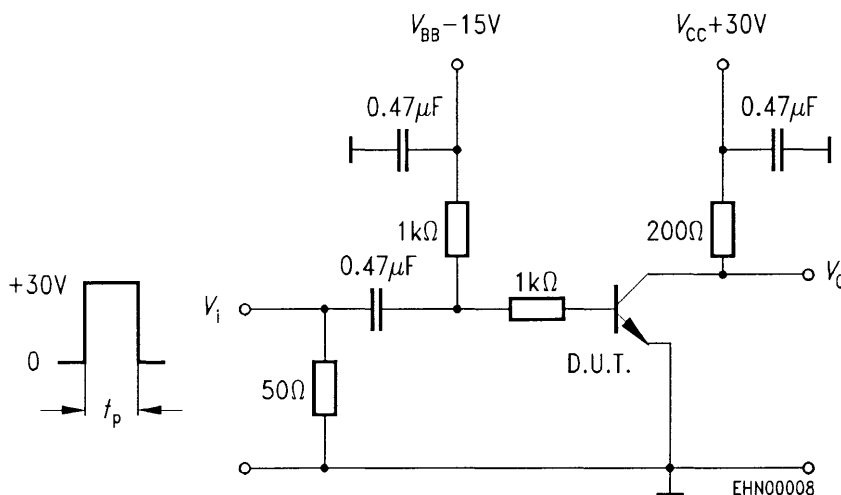

Pulse generator:

duty factor $D = 2 \%$
 pulse duration $t_p = 200 \text{ ns}$
 rise time $t_r \leq 2 \text{ ns}$
 output impedance $Z_o = 50 \Omega$

Oscillograph:

rise time $t_r \leq 5 \text{ ns}$
 output impedance $Z_i = 10 \text{ M}\Omega$

Total power dissipation $P_{tot} = f(T_A^*; T_S)$

* Package mounted on epoxy

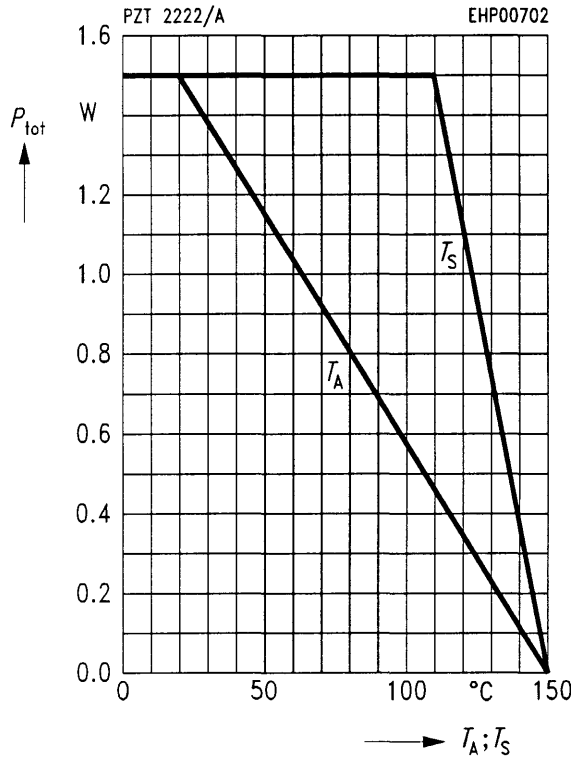

Transition frequency $f_T = f(I_C)$

$V_{CE} = 20\text{ V}, f = 100\text{ MHz}$

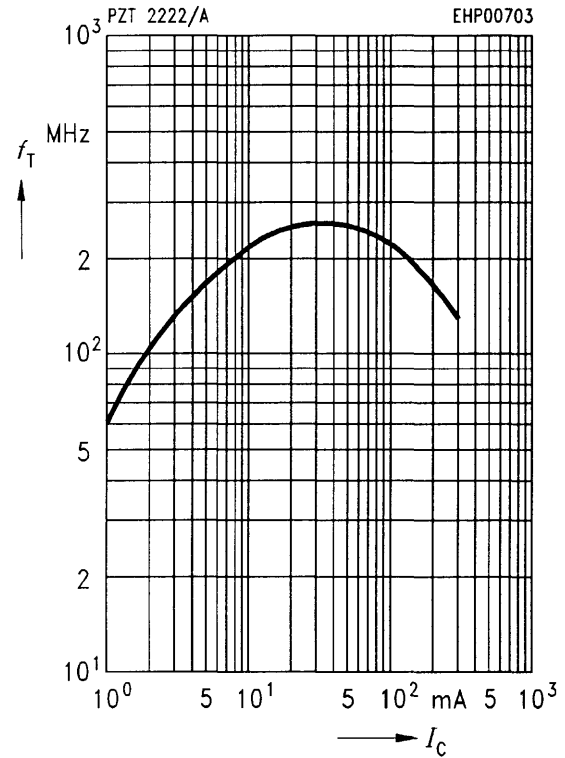

Saturation voltage $I_C = f(V_{BEsat}, V_{CEsat})$

$h_{FE} = 10$

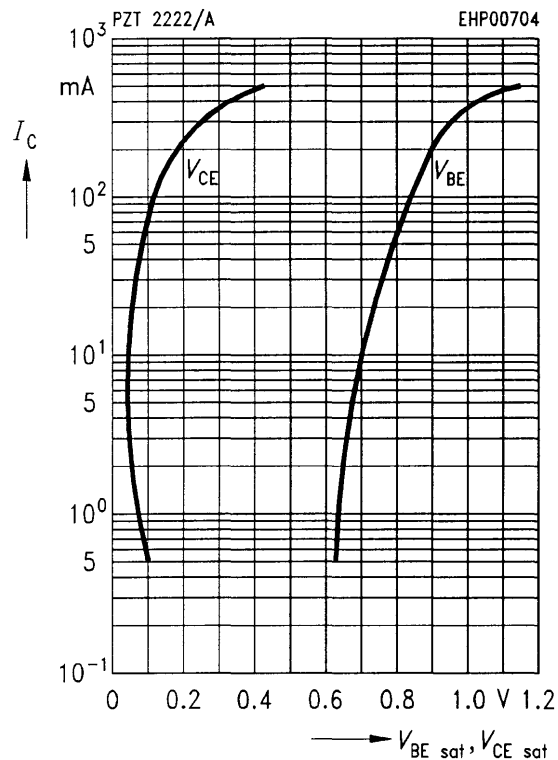

DC current gain $h_{FE} = f(I_C)$

$V_{CE} = 10\text{ V}$

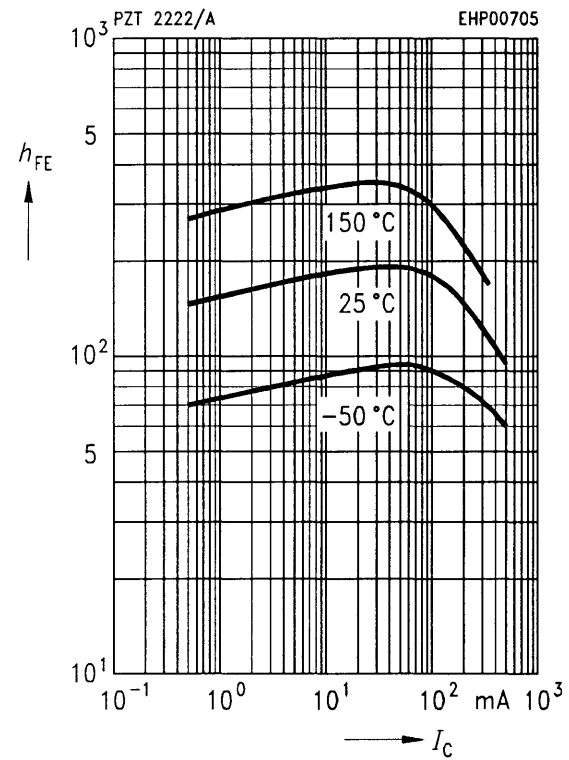

Permissible pulse load $P_{\text{tot max}}/P_{\text{tot DC}} = f(t_p)$

