

## Features

- 68 Input by 68 Output Crosspoint Switch
- 3.2Gb/s NRZ Data Bandwidth
- 66MHz Multi-Mode Programming Port
- TTL/2.5V CMOS Control I/O (3.3V tolerant)
- Programmable On-Chip I/O Termination
- Input Signal Activity (ISA) Monitoring Function
- Integrated Signal Equalization (ISE) for Deterministic Jitter Reduction
- Single 2.5V Supply
- Differential CML Output Driver
- 11W typ/14W max (low drive mode)  
13W typ/16W max (high drive mode)
- Hard and Soft Power-Down for Unused Channels
- High Performance 37.5mm, 480 TBGA Package

## General Description

The VSC837 is a monolithic 68x68 asynchronous crosspoint switch, designed to carry broadband data streams. The non-blocking switch core is programmed through a triple-mode port interface that allows random access programming of each input/output port. A high degree of signal integrity is maintained throughout the chip via fully differential signal paths.

The crosspoint function is based on a multiplexer array architecture. Each data output is driven by a 68:1 multiplexer that can be programmed to one and only one of its 68 inputs. The signal path is unregistered and fully asynchronous, so there are no restrictions on the phase, frequency, or signal pattern at each input.

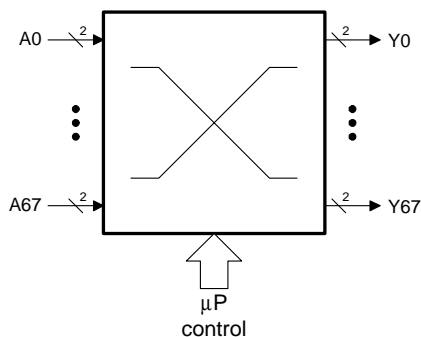
Each high-speed output is a fully differential switched current driver with switchable on-die terminations for maximum signal integrity. Data inputs are terminated on die through 100Ω resistors between true and complement inputs (see *Input Termination* section for further detail).

A triple-mode programming interface is provided that allows programming commands to be sent as serial data or one of two forms of parallel data. The input-referred mode (burst mode) allows an input port to be routed to all outputs in only 4 program cycles. Core programming can be random for each port address, or multiple program assignments can be queued and issued simultaneously. The programming may be initialized to a “straight-through” configuration (A0 to Y0, A1 to Y1, etc.) using the INITB pin.

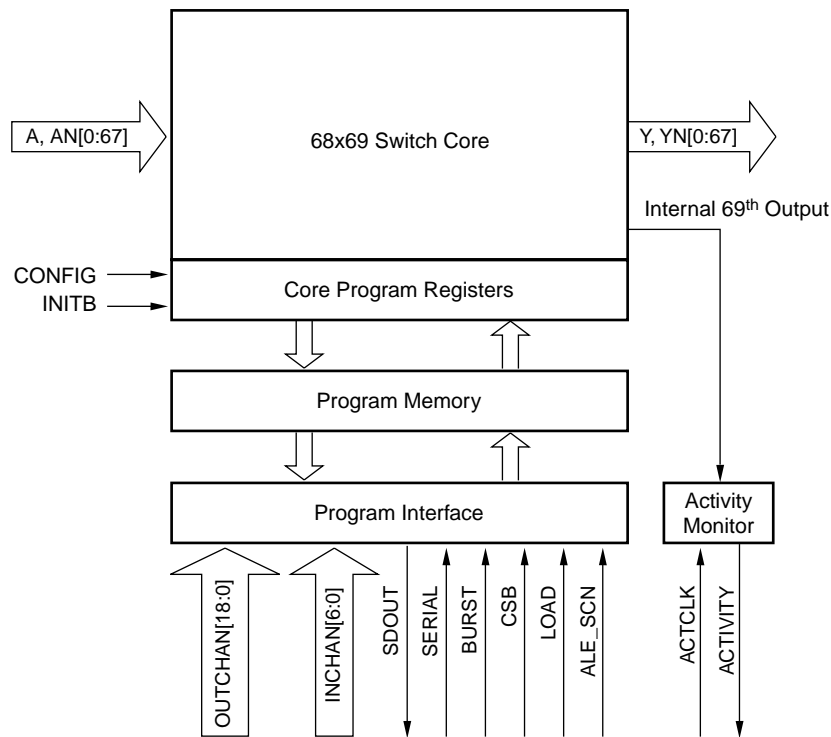
An activity monitor is provided to allow in-system diagnostics. The activity monitor can observe any high-speed input via an internal 69th multiplexer.

Unused channels may be powered down to allow efficient use of the switch in applications that require only a subset of the channels. Power-down can be accomplished in hardware, via dedicated power pins for pairs of input and output channels, or in software by programming individual unused outputs with a disable code.

## VSC837 Block Diagram



## Functional Block Diagram



## Functional Description

### Input / Output Characteristics

All input data must be differential and should be nominally biased to +2.0V or AC-coupled. Other levels are allowed as described under the *Input Termination* section. On-chip terminations are provided, with a nominal impedance of 100Ω differential. All input termination resistors float with an internal bias provided for AC-coupling.

For direct interconnection of multiple VSC837 devices, a CML termination mode is provided by tying the ITC pin to V<sub>CC</sub>, which ties the center point of the 100Ω termination to V<sub>CC</sub>, causing the terminations to act as loads for an open-drain or open-collector differential output.

Data outputs are provided through differential current switches with on-chip back-termination. The output circuit is capable of driving external 50Ω far-end termination (recommended). The output back-terminations are electronically switchable to enable a power savings of 2W (max) by reducing the output driver current.

## **Programming Interface**

### **Parallel Mode**

In parallel mode (SERIAL=0, BURST=0), the binary word on INCHAN[6:0] is the numerical identifier of the input that will be routed to the specified output. OUTCHAN[6:0] is the numerical identifier of the output being programmed. A rising edge on the LOAD signal will transfer the programming data to the shadow register in the program memory. Raising CONFIG (asynchronously) will transfer the programming data to the main latches in the program memory and cause the internal select signals in the core to re-configure the multiplexer. Lowering CONFIG will latch the main latches. CONFIG may be tied HIGH to enable programming take effect instantaneously.

This interface may be used with multiplexed address/data buses by using only INCHAN[6:0] without OUTCHAN[6:0] and dropping ALE when the address of the output to be programmed is present on INCHAN[6:0]. After the address is latched, the input address may be presented on INCHAN[6:0] and programming proceeds as above.

No read-back capability is provided in parallel mode. Read-back for diagnostic purposes is provided in serial mode via the scan function.

### **Serial Mode**

In serial mode (SERIAL=1, BURST=0), the INCHAN0 pin becomes the serial data input and the INCHAN1 pin becomes the serial clock (rising edge triggered). A serial word of the form [Output][Input] is shifted into the internal shift register, and the LOAD pin is asserted (HIGH) coincident with the last bit of the data word to signal that the word is to be applied. This transfers the input identifier to the shadow register of the addressed output. CONFIG is then applied (asynchronously) to transfer one or more program commands to the main latches of the program memories.

The SDOUT pin follows the data on the INCHAN0\_SDIN pin 14 clock cycles later. This enables the user to chain the serial ports of several crosspoints, shift program data for all switches through such a chain, and assert LOAD on all switches simultaneously to program all of the connections simultaneously.

The output field is 7 bits long, representing the binary numerical identifier of the output to be programmed. The input field is 7 bits long, representing the numerical identifier of the input that will be routed to the specified output.

### **Serial Read-Back**

Read-back of the program memory contents is accomplished in serial mode by setting the ALE\_SCN pin HIGH. This will serially shift out the contents of the main latches in the program memories, slice 68 first and slice 0 last, and MSB-first, LSB-last for each 7-bit word. One rising edge of INCHAN1\_SCLK with ALE\_SCN=0 and SERIAL=1 must occur to load the entire 483-bit shift register prior to shifting out data. At a clock rate of 66MHz, this operation takes 7.26 $\mu$ s.

### Burst Mode

Burst mode programming (BURST=1, SERIAL=0) enables an input to be broadcast to any group of 1 to 17 outputs with a single command. In this mode, rising edges on the LOAD pin will trigger program operations. The INCHAN[6:0] pins represent the input to be broadcast. The OUTCHAN[18:17] pins represent the page (quarter) of the program memory to access, and each of the OUTCHAN[16:0] pins represents 1 of the 17 outputs within that page. A '1' on any of those pins will cause that output to be programmed to connect to the input named on INCHAN[6:0].

No read-back capability is provided in burst mode. See *Serial Read-Back* section above.

### Activity Monitoring

The activity monitor observes the output of the internal 69th output from the core. By programming the 69th output to observe various inputs, the input signals can be scanned for activity or lack thereof. Each rising edge of ACTCLK causes the monitor to read out the activity state from the previous ACTCLK period and clears the internal activity state until a data transition triggers it again. There must be a minimum of one rising and one falling edge on the observed input data pin during the ACTCLK period for activity to be detected. After power-on the output of ACTIVITY after the first ACTCLK rising edge is unknown.

### Selective Power-Down

Unused input and output channels can be made to consume little or no power via one of two methods of selective power-down.

### Software Power-Down

Using this feature, unused outputs may be disabled, saving approximately 170 mW per channel for maximum dissipation conditions. This is accomplished by programming each unused output to look at input 127 (7F Hex), which represents a non-existent input channel. The channel may be subsequently activated by programming a valid input address. It is recommended, however, that any changes in power programming only be executed as part of an initialization sequence to guard against the effects of any switching transients that might result from changing the power supply current suddenly. Software mode does not affect the functioning or power of unused input channels.

### Hardware Power-Down

Using this feature, the power associated with given pairs of inputs may be shut off by tying the corresponding  $V_{EE}$  pin to  $V_{CC}$  (see Table 10). Approximately 160 mW per input pair is saved under the maximum dissipation conditions. The power associated with given pairs of outputs, including their contribution to the core power, can be shut off by tying the corresponding  $V_{EE}$  pin to  $V_{CC}$  (see Table 10). Approximately 360 mW per output pair is saved under the maximum dissipation conditions.

Certain  $V_{EE}$  pins must always be active. In other words, tied to the most negative supply, so the corresponding inputs and outputs will always be on and consuming power. See Figure 6 and Table 10 for the location of these pins.

## AC Characteristics

**Table 1: Data Path**

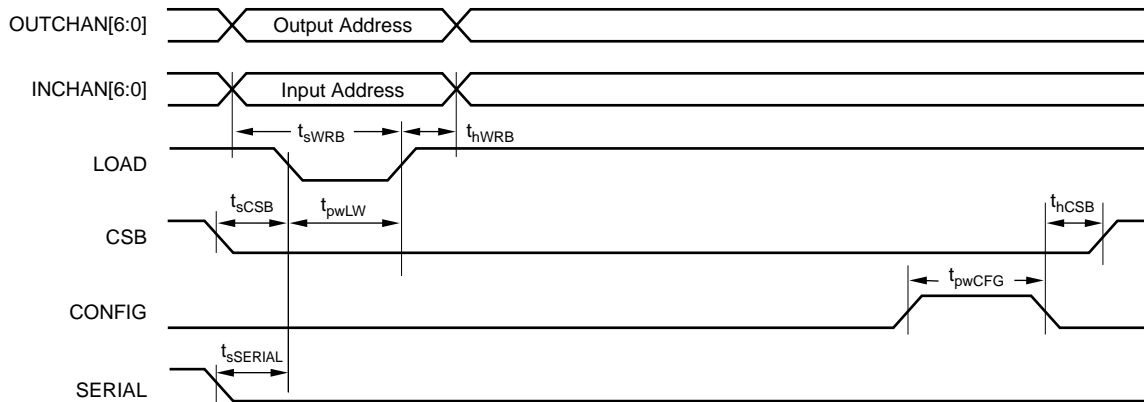
Symbol	Parameter	Min	Typ	Max	Units
f <sub>RATE</sub>	Maximum Data Rate	—	—	3.2	Gb/s
t <sub>SKW</sub>	Channel-to-channel delay skew	—	300	—	ps
t <sub>PDAY</sub>	Propagation Delay from an A input to a Y output	—	750	—	ps
t <sub>R</sub> , t <sub>F</sub>	High-speed input rise/fall times, 20% to 80%	—	—	150	ps
t <sub>R</sub> , t <sub>F</sub>	High-speed output rise/fall times, 20% to 80%	—	—	150	ps
t <sub>JR</sub>	Output added delay jitter, rms <sup>(1, 2)</sup>	—	—	10	ps
t <sub>JP</sub>	Output added delay jitter, peak-to-peak <sup>(1, 2)</sup>	—	—	40	ps

NOTES:(1) Tested on a sample basis only. (2) Broadband (unfiltered) deterministic jitter added to a jitter-free input, 2<sup>23</sup>-1 PRBS data pattern.

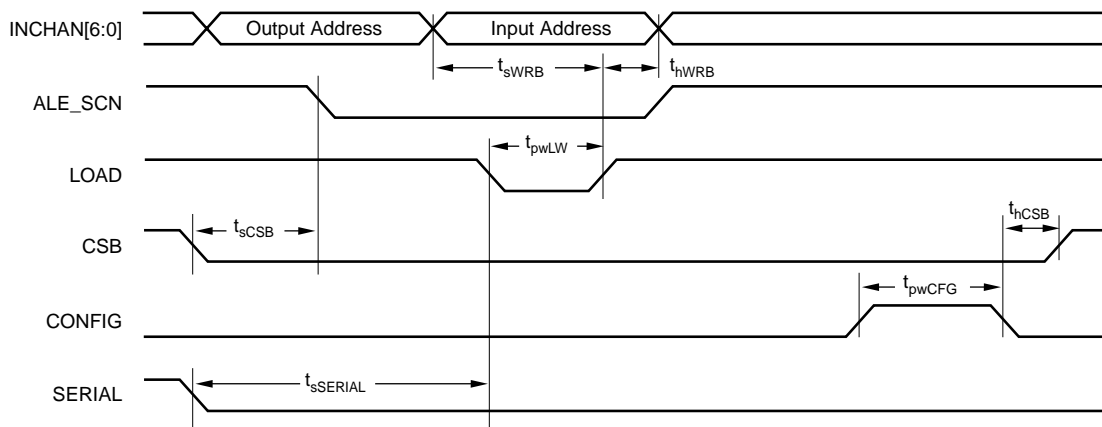
**Table 2: Program Interface Timing**

Symbol	Parameter	Min	Typ	Max	Units
t <sub>sWRB</sub>	Setup time from INCHAN[6:0] or OUTCHAN[6:0] to rising edge of WRB	3.35	—	—	ns
t <sub>hWRB</sub>	Hold time from rising edge of WRB to INCHAN[6:0] or OUTCHAN[6:0]	1.45	—	—	ns
t <sub>pwLW</sub>	Pulse width (HIGH or LOW) on LOAD	6.75	—	—	ns
t <sub>sCSB</sub>	Setup time from CSB to falling edge of LOAD or ALE_SCN in parallel or burst mode, or rising edge of LOAD in serial mode.	0	—	—	ns
t <sub>hCSB</sub>	Hold time of CSB rising edge after LOAD or ALE_SCN rising in parallel or burst mode, or falling edge of LOAD in serial mode, or falling edge of CONFIG in any mode.	0	—	—	ns
t <sub>pwCFG</sub>	Pulse width (HIGH or LOW) on CONFIG	6.75	—	—	ns
t <sub>sSDIN</sub>	Setup time from INCHAN0_SDIN to INCHAN1_SCLK rising	1.65	—	—	ns
t <sub>hSDIN</sub>	Hold time of INCHAN0_SDIN after INCHAN1_SCLK rising	1.0	—	—	ns
t <sub>perSCLK</sub>	Minimum period of SCLK in serial mode	15	—	—	ns
t <sub>sLOAD</sub>	Setup time from LOAD to INCHAN1_SCLK rising	1.85	—	—	ns
t <sub>hLOAD</sub>	Hold time of LOAD after INCHAN1_SCLK rising	0.95	—	—	ns
t <sub>sSERIAL</sub>	Setup time from SERIAL rising to INCHAN1_SCLK rising when entering serial mode or SERIAL falling to LOAD falling when entering parallel mode or SERIAL falling to LOAD rising when entering burst mode.	0.90	—	—	ns
t <sub>hSERIAL</sub>	Hold time from INCHAN1_SCLK rising to SERIAL falling when exiting serial mode.	0	—	—	ns
t <sub>sBURST</sub>	Setup time from BURST rising to LOAD rising when entering burst mode or BURST falling to LOAD falling when entering parallel mode.	1.85	—	—	ns
t <sub>hBURST</sub>	Hold time from LOAD rising to BURST falling when exiting burst mode.	2.45	—	—	ns
t <sub>dsDOUT</sub>	Delay from INCHAN1_SCLK rising to SDOUT, 20pF load.	—	—	6.20	ns
t <sub>pwINITB</sub>	Pulse width (HIGH or LOW) on INITB	6.75	—	—	ns
t <sub>sSCAN</sub>	Setup time from ALE_SCN to INCHAN1_SCLK rising when starting or completing a serial read-back sequence.	1.65	—	—	ns
t <sub>hSCAN</sub>	Hold time of ALE_SCN after INCHAN1_SCLK rising when starting or completing a serial read-back sequence.	1.0	—	—	ns

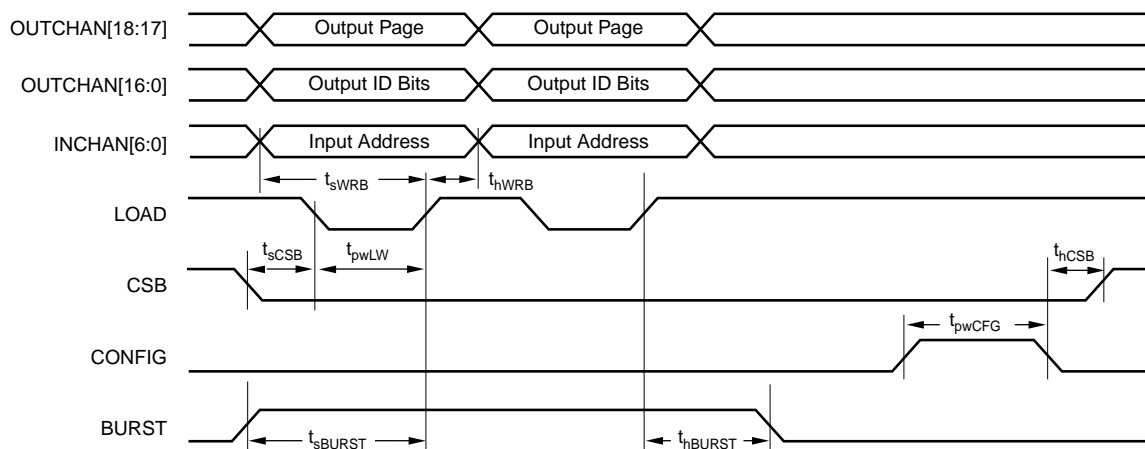
**Figure 1: Parallel Mode—Separate Address/Data (leave ALE\_SCN pin HIGH)**



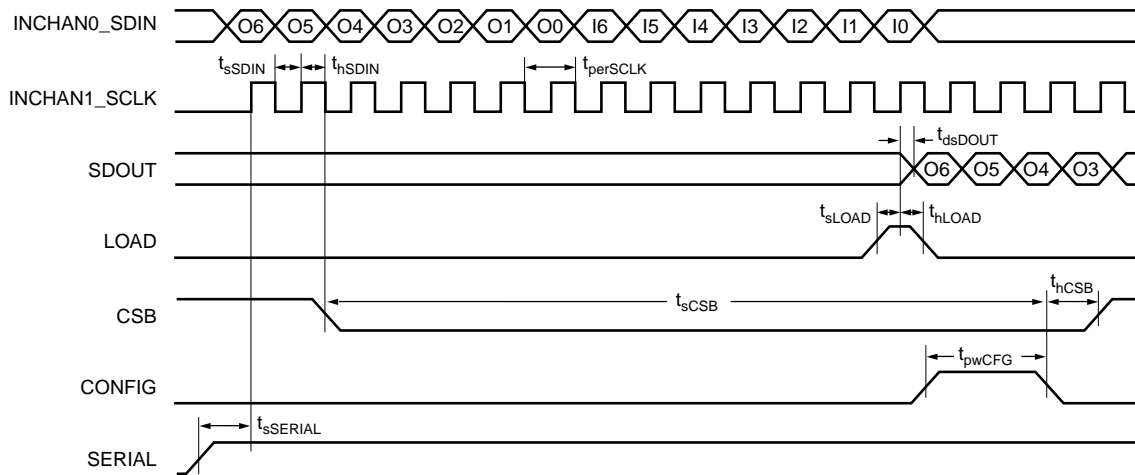
**Figure 2: Parallel Mode—Multiplexed Address/Data**



**Figure 3: Burst Mode**

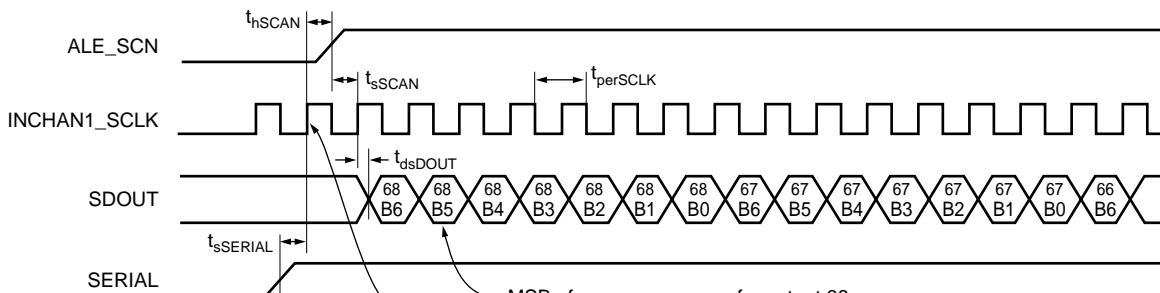


**Figure 4: Serial Mode (leave ALE\_SCN pin LOW during programming)**



O(n) = Output Address Bit (n), I(n) = Input Address Bit (n)

**Figure 5: Serial Read-Back**



MSB of program memory for output 68

Read-back shift register (483 bits long) is loaded here on rising edge of INCHAN1\_SCLK with SERIAL HIGH and ALE\_SCN LOW

## DC Characteristics

All characteristics are over the specified operating conditions.

**Table 3: Power Supply Requirements**

Symbol	Parameter	Min	Typ	Max	Units	Conditions
$I_{CC}$	$V_{CC}$ supply current		5600	6095	mA	
$P_T$	Total chip power (with $I_{TERM} = 0$ and back-terminations ON, high drive)		13	16	W	

**Table 4: Control Port Input Levels (TTL/CMOS)**

Symbol	Parameter	Min	Typ	Max	Units	Conditions
$V_{IH}$	Input HIGH voltage	1.7		$V_{CC}^+$ 1.0	V	
$V_{IL}$	Input LOW voltage	0		0.8	V	
$I_{IH}$	Input HIGH current			TBD	$\mu$ A	
$I_{IL}$	Input LOW current			TBD	$\mu$ A	
$V_{OH}$	Output HIGH voltage	$V_{CC}^-$ 0.2		$V_{CC}$	V	DC load < 500 $\mu$ A
$V_{OL}$	Output LOW voltage	0		0.2	V	DC load < 2mA
$V_{OHPU}$	$V_{OH}$ with external pull-up	2.4			V	250 $\Omega$ to 3.3V(5%)
$V_{OLPU}$	$V_{OL}$ with external pull-up			0.4	V	250 $\Omega$ to 3.3V(5%)

**Table 5: Signal Input Levels (high-speed signal path)**

Symbol	Parameter	Min	Typ	Max	Units	Conditions
$V_{IN}$	Input voltage amplitude	150		1100	mV	See Note 1
$V_{ICM}$	Input common-mode voltage	$V_{CC}^-$ 0.7		$V_{CC}^-$ 0.2	V	See Note 2

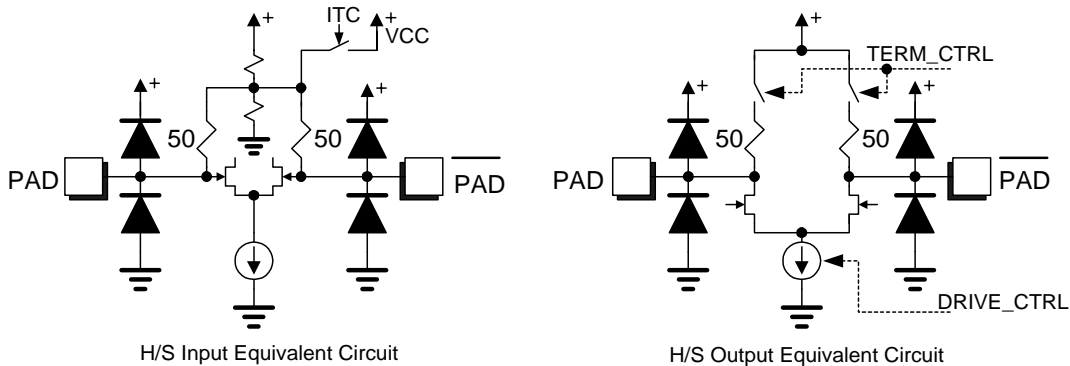
**Table 6: Signal Output Levels (high-speed signal path) TERM\_CTRL=ON, DRIVE\_CTRL=HI**

Symbol	Parameter	Min	Typ	Max	Units	Conditions
$V_{OUT}$	Output differential voltage	400		600	mV	See Note 1, 3
$V_{OCM}$	Output common-mode voltage	$V_{CC}^-$ 0.3		$V_{CC}^-$ 0.2	V	See Note 2, 3

NOTES: (1) Mean peak-to-peak amplitude measurement of either true or complement of the differential signal. (2)  $V_{CC} = V_{CCP} = 2.5V$ ,  $V_{EE} = 0V$ . (3) Terminated in 50 $\Omega$  to  $V_{CC}$ . This termination is used for testing the part, but other terminations are allowed—see Table 9.



## I/O Equivalent Circuits



## Input Termination

The high-speed inputs of the VSC837 are internally terminated by a 100Ω resistor between true and complement inputs. Termination resistors are isolated from each other on-chip. The termination will self-bias to +2.0V (nominal) for AC-coupled applications. The ITC pin enables direct interconnection of multiple VSC837 devices. With ITC tied to V<sub>CC</sub>, the center point of the 100Ω termination resistor is tied to V<sub>CC</sub>, causing the terminations to act as loads for an open-drain or open-collector differential output.

**Table 7: Allowed Input Termination Schemes**

Type	Description	Comments
1	AC-coupled input	Tie ITC LOW, 100Ω differential input termination, input self-biased
2	DC-coupled from open-drain CML	Tie ITC HIGH, terminations acts as 50Ω load to V <sub>CC</sub>
3	DC-coupled from back-terminated 2.5V CML	Tie ITC HIGH, terminations acts as 50Ω load to V <sub>CC</sub>
4	DC-coupled from back-terminated 2.5V CML	Tie ITC LOW, 100Ω differential termination (preferred over Type 3)
5	DC-coupled from back-terminated 3.3V LV-PECL	Tie ITC LOW, 100Ω differential termination

Some allowed termination schemes result in additional I<sub>CC</sub> current and power dissipation on-chip. See Table 8.

**Table 8: Additional Current and Power**

Symbol	Description	Min	Typ	Max	Units	Conditions
I <sub>CC-c</sub>	Additional ICC current when receiving DC-Coupled CML (ITC = HIGH)			680	mA	
P <sub>CC-c</sub>	Additional power dissipated on-chip for DC terminating CML at inputs			0.340	W	

## Output Termination

The high-speed outputs of the VSC837 are internally back terminated by 50Ω to V<sub>CC</sub> when the TERM\_CTRL pin is HIGH. When this pin is LOW, the output driver functions as an open-drain CML driver. Setting DRIVE\_CTRL LOW (GND) saves 2W under maximum power dissipation conditions. See Table 9 for allowable types of terminations and modes of operation.

**Table 9: Allowed High-Speed Output Terminations and Modes of Operation**

Type	Description	DRIVE_CTRL	TERM_CTRL	V <sub>OD</sub> <sup>(1)</sup> (mV) typ	V <sub>OCM</sub> <sup>(1)</sup> (V) typ
1	AC-Coupled to 50Ω termination to any voltage	V <sub>CC</sub> (HIGH)	V <sub>CC</sub> (ON)	500	2.0
2	AC-Coupled to 100Ω differential termination	V <sub>CC</sub> (HIGH)	V <sub>CC</sub> (ON)	500	2.0
3	DC-Coupled, terminated in 50Ω to V <sub>CC</sub> at far-end only	GND (LOW)	GND (OFF)	500	2.25
4	DC-Coupled, terminated in 50Ω to V <sub>CC</sub> at far-end only	V <sub>CC</sub> (HIGH)	GND (OFF)	1000	2.0
5	DC-Coupled, source and far-end terminated in 50Ω to V <sub>CC</sub>	GND (LOW)	V <sub>CC</sub> (ON)	250	2.375
6	DC-Coupled, source and far-end terminated in 50Ω to V <sub>CC</sub>	V <sub>CC</sub> (HIGH)	V <sub>CC</sub> (ON)	500	2.25
7	DC-Coupled, 100Ω differential termination	GND (LOW)	V <sub>CC</sub> (ON)	250	2.25
8	DC-Coupled, 100Ω differential termination	V <sub>CC</sub> (HIGH)	V <sub>CC</sub> (ON)	500	2.0

NOTE: (1) Measured at output of VSC837, with V<sub>CC</sub> = 2.5V.

## Absolute Maximum Ratings<sup>(1)</sup>

Power Supply Voltage (V <sub>CC</sub> ) Potential to GND .....	-0.5V to +4.V
TTL Input Voltage Applied .....	-0.5V to V <sub>CC</sub> +1.0V
ECL Input Voltage Applied .....	-0.5V to V <sub>CC</sub> +0.5V
Output Current (I <sub>OUT</sub> ) .....	50mA
Case Temperature Under Bias (T <sub>C</sub> ) .....	-55°C to + 125°C
Storage Temperature (T <sub>STG</sub> ) .....	-65°C to + 150°C

NOTE: (1) Caution: Stresses listed under "Absolute Maximum Ratings" may be applied to devices one at a time without causing permanent damage. Functionality at or exceeding the values listed is not implied. Exposure to these values for extended periods may affect device reliability.

## Operating Conditions

Supply Voltage (V <sub>EE</sub> ).....	0V
Supply Voltage (V <sub>CC</sub> ) .....	+2.5V ±5%
Supply Voltage (V <sub>CCP</sub> ).....	+2.5V ±5%
Case Temperature Operating Range (T).....	0°C to 85°C



**Table 10: Package Pin Identifications**

<i>Signal Name</i>	<i>Pin</i>	<i>Function</i>	<i>Level</i>
<b>High-Speed Data Inputs</b>			
A0	D23	High-Speed Data Input Channel 0, True	PECL
A1	AH23	High-Speed Data Input Channel 1, True	PECL
A2	B23	High-Speed Data Input Channel 2, True	PECL
A3	AF23	High-Speed Data Input Channel 3, True	PECL
A4	D22	High-Speed Data Input Channel 4, True	PECL
A5	AH22	High-Speed Data Input Channel 5, True	PECL
A6	B22	High-Speed Data Input Channel 6, True	PECL
A7	AF22	High-Speed Data Input Channel 7, True	PECL
A8	D21	High-Speed Data Input Channel 8, True	PECL
A9	AH21	High-Speed Data Input Channel 9, True	PECL
A10	B21	High-Speed Data Input Channel 10, True	PECL
A11	AF21	High-Speed Data Input Channel 11, True	PECL
A12	D20	High-Speed Data Input Channel 12, True	PECL
A13	AH20	High-Speed Data Input Channel 13, True	PECL
A14	B20	High-Speed Data Input Channel 14, True	PECL
A15	AF20	High-Speed Data Input Channel 15, True	PECL
A16	D19	High-Speed Data Input Channel 16, True	PECL
A17	AH19	High-Speed Data Input Channel 17, True	PECL
A18	B19	High-Speed Data Input Channel 18, True	PECL
A19	AF19	High-Speed Data Input Channel 19, True	PECL
A20	D18	High-Speed Data Input Channel 20, True	PECL
A21	AH18	High-Speed Data Input Channel 21, True	PECL
A22	B18	High-Speed Data Input Channel 22, True	PECL
A23	AF18	High-Speed Data Input Channel 23, True	PECL
A24	D17	High-Speed Data Input Channel 24, True	PECL
A25	AH17	High-Speed Data Input Channel 25, True	PECL
A26	B17	High-Speed Data Input Channel 26, True	PECL
A27	AF17	High-Speed Data Input Channel 27, True	PECL
A28	D16	High-Speed Data Input Channel 28, True	PECL
A29	AH16	High-Speed Data Input Channel 29, True	PECL
A30	B16	High-Speed Data Input Channel 30, True	PECL
A31	AF16	High-Speed Data Input Channel 31, True	PECL
A32	D15	High-Speed Data Input Channel 32, True	PECL
A33	AH15	High-Speed Data Input Channel 33, True	PECL
A34	B15	High-Speed Data Input Channel 34, True	PECL
A35	AF15	High-Speed Data Input Channel 35, True	PECL

## Preliminary Data Sheet

### VSC837

3.2Gb/s  
68x68 Crosspoint Switch

<i>Signal Name</i>	<i>Pin</i>	<i>Function</i>	<i>Level</i>
A36	D14	High-Speed Data Input Channel 36, True	PECL
A37	AH14	High-Speed Data Input Channel 37, True	PECL
A38	B14	High-Speed Data Input Channel 38, True	PECL
A39	AF14	High-Speed Data Input Channel 39, True	PECL
A40	D13	High-Speed Data Input Channel 40, True	PECL
A41	AH13	High-Speed Data Input Channel 41, True	PECL
A42	B13	High-Speed Data Input Channel 42, True	PECL
A43	AF13	High-Speed Data Input Channel 43, True	PECL
A44	D12	High-Speed Data Input Channel 44, True	PECL
A45	AH12	High-Speed Data Input Channel 45, True	PECL
A46	B12	High-Speed Data Input Channel 46, True	PECL
A47	AF12	High-Speed Data Input Channel 47, True	PECL
A48	D11	High-Speed Data Input Channel 48, True	PECL
A49	AH11	High-Speed Data Input Channel 49, True	PECL
A50	B11	High-Speed Data Input Channel 50, True	PECL
A51	AF11	High-Speed Data Input Channel 51, True	PECL
A52	D10	High-Speed Data Input Channel 52, True	PECL
A53	AH10	High-Speed Data Input Channel 53, True	PECL
A54	B10	High-Speed Data Input Channel 54, True	PECL
A55	AF10	High-Speed Data Input Channel 55, True	PECL
A56	D9	High-Speed Data Input Channel 56, True	PECL
A57	AH9	High-Speed Data Input Channel 57, True	PECL
A58	B9	High-Speed Data Input Channel 58, True	PECL
A59	AF9	High-Speed Data Input Channel 59, True	PECL
A60	D8	High-Speed Data Input Channel 60, True	PECL
A61	AH8	High-Speed Data Input Channel 61, True	PECL
A62	B8	High-Speed Data Input Channel 62, True	PECL
A63	AF8	High-Speed Data Input Channel 63, True	PECL
A64	D7	High-Speed Data Input Channel 64, True	PECL
A65	AH7	High-Speed Data Input Channel 65, True	PECL
A66	B7	High-Speed Data Input Channel 66 True	PECL
A67	AF7	High-Speed Data Input Channel 67, True	PECL
AN0	E23	High-Speed Data Input Channel 0, Complement	PECL
AN1	AJ23	High-Speed Data Input Channel 1, Complement	PECL
AN2	A23	High-Speed Data Input Channel 2, Complement	PECL
AN3	AE23	High-Speed Data Input Channel 3, Complement	PECL
AN4	E22	High-Speed Data Input Channel 4, Complement	PECL
AN5	AJ22	High-Speed Data Input Channel 5, Complement	PECL
AN6	A22	High-Speed Data Input Channel 6, Complement	PECL

<i>Signal Name</i>	<i>Pin</i>	<i>Function</i>	<i>Level</i>
AN7	AE22	High-Speed Data Input Channel 7, Complement	PECL
AN8	E21	High-Speed Data Input Channel 8, Complement	PECL
AN9	AJ21	High-Speed Data Input Channel 9, Complement	PECL
AN10	A21	High-Speed Data Input Channel 10, Complement	PECL
AN11	AE21	High-Speed Data Input Channel 11, Complement	PECL
AN12	E20	High-Speed Data Input Channel 12, Complement	PECL
AN13	AJ20	High-Speed Data Input Channel 13, Complement	PECL
AN14	A20	High-Speed Data Input Channel 14, Complement	PECL
AN15	AE20	High-Speed Data Input Channel 15, Complement	PECL
AN16	E19	High-Speed Data Input Channel 16, Complement	PECL
AN17	AJ19	High-Speed Data Input Channel 17, Complement	PECL
AN18	A19	High-Speed Data Input Channel 18, Complement	PECL
AN19	AE19	High-Speed Data Input Channel 19, Complement	PECL
AN20	E18	High-Speed Data Input Channel 20, Complement	PECL
AN21	AJ18	High-Speed Data Input Channel 21, Complement	PECL
AN22	A18	High-Speed Data Input Channel 22, Complement	PECL
AN23	AE18	High-Speed Data Input Channel 23, Complement	PECL
AN24	E17	High-Speed Data Input Channel 24, Complement	PECL
AN25	AJ17	High-Speed Data Input Channel 25, Complement	PECL
AN26	A17	High-Speed Data Input Channel 26, Complement	PECL
AN27	AE17	High-Speed Data Input Channel 27, Complement	PECL
AN28	E16	High-Speed Data Input Channel 28, Complement	PECL
AN29	AJ16	High-Speed Data Input Channel 29, Complement	PECL
AN30	A16	High-Speed Data Input Channel 30, Complement	PECL
AN31	AE16	High-Speed Data Input Channel 31, Complement	PECL
AN32	E15	High-Speed Data Input Channel 32, Complement	PECL
AN33	AJ15	High-Speed Data Input Channel 33, Complement	PECL
AN34	A15	High-Speed Data Input Channel 34, Complement	PECL
AN35	AE15	High-Speed Data Input Channel 35, Complement	PECL
AN36	E14	High-Speed Data Input Channel 36, Complement	PECL
AN37	AJ14	High-Speed Data Input Channel 37, Complement	PECL
AN38	A14	High-Speed Data Input Channel 38, Complement	PECL
AN39	AE14	High-Speed Data Input Channel 39, Complement	PECL
AN40	E13	High-Speed Data Input Channel 40, Complement	PECL
AN41	AJ13	High-Speed Data Input Channel 41, Complement	PECL
AN42	A13	High-Speed Data Input Channel 42, Complement	PECL
AN43	AE13	High-Speed Data Input Channel 43, Complement	PECL
AN44	E12	High-Speed Data Input Channel 44, Complement	PECL
AN45	AJ12	High-Speed Data Input Channel 45, Complement	PECL

## Preliminary Data Sheet

### VSC837

3.2Gb/s  
68x68 Crosspoint Switch

<i>Signal Name</i>	<i>Pin</i>	<i>Function</i>	<i>Level</i>
AN46	A12	High-Speed Data Input Channel 46, Complement	PECL
AN47	AE12	High-Speed Data Input Channel 47, Complement	PECL
AN48	E11	High-Speed Data Input Channel 48, Complement	PECL
AN49	AJ11	High-Speed Data Input Channel 49, Complement	PECL
AN50	A11	High-Speed Data Input Channel 50, Complement	PECL
AN51	AE11	High-Speed Data Input Channel 51, Complement	PECL
AN52	E10	High-Speed Data Input Channel 52, Complement	PECL
AN53	AJ10	High-Speed Data Input Channel 53, Complement	PECL
AN54	A10	High-Speed Data Input Channel 54, Complement	PECL
AN55	AE10	High-Speed Data Input Channel 55, Complement	PECL
AN56	E9	High-Speed Data Input Channel 56, Complement	PECL
AN57	AJ9	High-Speed Data Input Channel 57, Complement	PECL
AN58	A9	High-Speed Data Input Channel 58, Complement	PECL
AN59	AE9	High-Speed Data Input Channel 59, Complement	PECL
AN60	E8	High-Speed Data Input Channel 60, Complement	PECL
AN61	AJ8	High-Speed Data Input Channel 61, Complement	PECL
AN62	A8	High-Speed Data Input Channel 62, Complement	PECL
AN63	AE8	High-Speed Data Input Channel 63, Complement	PECL
AN64	E7	High-Speed Data Input Channel 64, Complement	PECL
AN65	AJ7	High-Speed Data Input Channel 65, Complement	PECL
AN66	A7	High-Speed Data Input Channel 66, Complement	PECL
AN67	AE7	High-Speed Data Input Channel 67, Complement	PECL
<b>High-Speed Data Outputs</b>			
Y0	G28	High-Speed Data Output Channel 0, True	CML
Y1	G4	High-Speed Data Output Channel 1, True	CML
Y2	G26	High-Speed Data Output Channel 2, True	CML
Y3	G2	High-Speed Data Output Channel 3, True	CML
Y4	H28	High-Speed Data Output Channel 4, True	CML
Y5	H4	High-Speed Data Output Channel 5, True	CML
Y6	H26	High-Speed Data Output Channel 6, True	CML
Y7	H2	High-Speed Data Output Channel 7, True	CML
Y8	J28	High-Speed Data Output Channel 8, True	CML
Y9	J4	High-Speed Data Output Channel 9, True	CML
Y10	J26	High-Speed Data Output Channel 10, True	CML
Y11	J2	High-Speed Data Output Channel 11, True	CML
Y12	K28	High-Speed Data Output Channel 12, True	CML
Y13	K4	High-Speed Data Output Channel 13, True	CML
Y14	K26	High-Speed Data Output Channel 14, True	CML
Y15	K2	High-Speed Data Output Channel 15, True	CML

<i>Signal Name</i>	<i>Pin</i>	<i>Function</i>	<i>Level</i>
Y16	L28	High-Speed Data Output Channel 16, True	CML
Y17	L4	High-Speed Data Output Channel 17, True	CML
Y18	L26	High-Speed Data Output Channel 18, True	CML
Y19	L2	High-Speed Data Output Channel 19, True	CML
Y20	M28	High-Speed Data Output Channel 20, True	CML
Y21	M4	High-Speed Data Output Channel 21, True	CML
Y22	M26	High-Speed Data Output Channel 22, True	CML
Y23	M2	High-Speed Data Output Channel 23, True	CML
Y24	N28	High-Speed Data Output Channel 24, True	CML
Y25	N4	High-Speed Data Output Channel 25, True	CML
Y26	N26	High-Speed Data Output Channel 26, True	CML
Y27	N2	High-Speed Data Output Channel 27, True	CML
Y28	P28	High-Speed Data Output Channel 28, True	CML
Y29	P4	High-Speed Data Output Channel 29, True	CML
Y30	P26	High-Speed Data Output Channel 30, True	CML
Y31	P2	High-Speed Data Output Channel 31, True	CML
Y32	R28	High-Speed Data Output Channel 32, True	CML
Y33	R4	High-Speed Data Output Channel 33, True	CML
Y34	R26	High-Speed Data Output Channel 34, True	CML
Y35	R2	High-Speed Data Output Channel 35, True	CML
Y36	T28	High-Speed Data Output Channel 36, True	CML
Y37	T4	High-Speed Data Output Channel 37, True	CML
Y38	T26	High-Speed Data Output Channel 38, True	CML
Y39	T2	High-Speed Data Output Channel 39, True	CML
Y40	U28	High-Speed Data Output Channel 40, True	CML
Y41	U4	High-Speed Data Output Channel 41, True	CML
Y42	U26	High-Speed Data Output Channel 42, True	CML
Y43	U2	High-Speed Data Output Channel 43, True	CML
Y44	V28	High-Speed Data Output Channel 44, True	CML
Y45	V4	High-Speed Data Output Channel 45, True	CML
Y46	V26	High-Speed Data Output Channel 46, True	CML
Y47	V2	High-Speed Data Output Channel 47, True	CML
Y48	W28	High-Speed Data Output Channel 48, True	CML
Y49	W4	High-Speed Data Output Channel 49, True	CML
Y50	W26	High-Speed Data Output Channel 50, True	CML
Y51	W2	High-Speed Data Output Channel 51, True	CML
Y52	Y28	High-Speed Data Output Channel 52, True	CML
Y53	Y4	High-Speed Data Output Channel 53, True	CML
Y54	Y26	High-Speed Data Output Channel 54, True	CML



## Preliminary Data Sheet

### VSC837

3.2Gb/s  
68x68 Crosspoint Switch

<i>Signal Name</i>	<i>Pin</i>	<i>Function</i>	<i>Level</i>
Y55	Y2	High-Speed Data Output Channel 55, True	CML
Y56	AA28	High-Speed Data Output Channel 56, True	CML
Y57	AA4	High-Speed Data Output Channel 57, True	CML
Y58	AA26	High-Speed Data Output Channel 58, True	CML
Y59	AA2	High-Speed Data Output Channel 59, True	CML
Y60	AB28	High-Speed Data Output Channel 60, True	CML
Y61	AB4	High-Speed Data Output Channel 61, True	CML
Y62	AB26	High-Speed Data Output Channel 62, True	CML
Y63	AB2	High-Speed Data Output Channel 63, True	CML
Y64	AC28	High-Speed Data Output Channel 64, True	CML
Y65	AC4	High-Speed Data Output Channel 65, True	CML
Y66	AC26	High-Speed Data Output Channel 66, True	CML
Y67	AC2	High-Speed Data Output Channel 67, True	CML
YN0	G29	High-Speed Data Output Channel 0, Complement	CML
YN1	G5	High-Speed Data Output Channel 1, Complement	CML
YN2	G25	High-Speed Data Output Channel 2, Complement	CML
YN3	G1	High-Speed Data Output Channel 3, Complement	CML
YN4	H29	High-Speed Data Output Channel 4, Complement	CML
YN5	H5	High-Speed Data Output Channel 5, Complement	CML
YN6	H25	High-Speed Data Output Channel 6, Complement	CML
YN7	H1	High-Speed Data Output Channel 7, Complement	CML
YN8	J29	High-Speed Data Output Channel 8, Complement	CML
YN9	J5	High-Speed Data Output Channel 9, Complement	CML
YN10	J25	High-Speed Data Output Channel 10, Complement	CML
YN11	J1	High-Speed Data Output Channel 11, Complement	CML
YN12	K29	High-Speed Data Output Channel 12, Complement	CML
YN13	K5	High-Speed Data Output Channel 13, Complement	CML
YN14	K25	High-Speed Data Output Channel 14, Complement	CML
YN15	K1	High-Speed Data Output Channel 15, Complement	CML
YN16	L29	High-Speed Data Output Channel 16, Complement	CML
YN17	L5	High-Speed Data Output Channel 17, Complement	CML
YN18	L25	High-Speed Data Output Channel 18, Complement	CML
YN19	L1	High-Speed Data Output Channel 19, Complement	CML
YN20	M29	High-Speed Data Output Channel 20, Complement	CML
YN21	M5	High-Speed Data Output Channel 21, Complement	CML
YN22	M25	High-Speed Data Output Channel 22, Complement	CML
YN23	M1	High-Speed Data Output Channel 23, Complement	CML
YN24	N29	High-Speed Data Output Channel 24, Complement	CML
YN25	N5	High-Speed Data Output Channel 25, Complement	CML

<i>Signal Name</i>	<i>Pin</i>	<i>Function</i>	<i>Level</i>
YN26	N25	High-Speed Data Output Channel 26, Complement	CML
YN27	N1	High-Speed Data Output Channel 27, Complement	CML
YN28	P29	High-Speed Data Output Channel 28, Complement	CML
YN29	P5	High-Speed Data Output Channel 29, Complement	CML
YN30	P25	High-Speed Data Output Channel 30, Complement	CML
YN31	P1	High-Speed Data Output Channel 31, Complement	CML
YN32	R29	High-Speed Data Output Channel 32, Complement	CML
YN33	R5	High-Speed Data Output Channel 33, Complement	CML
YN34	R25	High-Speed Data Output Channel 34, Complement	CML
YN35	R1	High-Speed Data Output Channel 35, Complement	CML
YN36	T29	High-Speed Data Output Channel 36, Complement	CML
YN37	T5	High-Speed Data Output Channel 37, Complement	CML
YN38	T25	High-Speed Data Output Channel 38, Complement	CML
YN39	T1	High-Speed Data Output Channel 39, Complement	CML
YN40	U29	High-Speed Data Output Channel 40, Complement	CML
YN41	U5	High-Speed Data Output Channel 41, Complement	CML
YN42	U25	High-Speed Data Output Channel 42, Complement	CML
YN43	U1	High-Speed Data Output Channel 43, Complement	CML
YN44	V29	High-Speed Data Output Channel 44, Complement	CML
YN45	V5	High-Speed Data Output Channel 45, Complement	CML
YN46	V25	High-Speed Data Output Channel 46, Complement	CML
YN47	V1	High-Speed Data Output Channel 47, Complement	CML
YN48	W29	High-Speed Data Output Channel 48, Complement	CML
YN49	W5	High-Speed Data Output Channel 49, Complement	CML
YN50	W25	High-Speed Data Output Channel 50, Complement	CML
YN51	W1	High-Speed Data Output Channel 51, Complement	CML
YN52	Y29	High-Speed Data Output Channel 52, Complement	CML
YN53	Y5	High-Speed Data Output Channel 53, Complement	CML
YN54	Y25	High-Speed Data Output Channel 54, Complement	CML
YN55	Y1	High-Speed Data Output Channel 55, Complement	CML
YN56	AA29	High-Speed Data Output Channel 56, Complement	CML
YN57	AA5	High-Speed Data Output Channel 57, Complement	CML
YN58	AA25	High-Speed Data Output Channel 58, Complement	CML
YN59	AA1	High-Speed Data Output Channel 59, Complement	CML
YN60	AB29	High-Speed Data Output Channel 60, Complement	CML
YN61	AB5	High-Speed Data Output Channel 61, Complement	CML
YN62	AB25	High-Speed Data Output Channel 62, Complement	CML
YN63	AB1	High-Speed Data Output Channel 63, Complement	CML
YN64	AC29	High-Speed Data Output Channel 64, Complement	CML

## Preliminary Data Sheet

### VSC837

3.2Gb/s  
68x68 Crosspoint Switch

Signal Name	Pin	Function	Level
YN65	AC5	High-Speed Data Output Channel 65, Complement	CML
YN66	AC25	High-Speed Data Output Channel 66, Complement	CML
YN67	AC1	High-Speed Data Output Channel 67, Complement	CML
<b>Control Pins</b>			
ACTCLK	AD2	Clock for Activity Monitor (<10MHz)	TTL
ACTIVITY	AD1	ActivityResult from Previous ACTCLK Period	TTL
ALE_SCN	AD25	Address Latch Enable for Multiplexed Parallel Mode; Scan Enable for Serial Mode. See Figures 2 through 6 for Proper Use.	TTL
BURST	AH6	Logic HIGH sets Burst Mode	TTL
CMV	AD3	Output Drive Current Control (leave floating)	ANALOG
CONFIG	F27	Logic HIGH Transfers Programming to Main Program Memory	TTL
CSB	AF6	Chip Select (active LOW)	TTL
DRIVE_CTRL	AD4	Output Drive Current Switch (LOW = 10mA, HIGH = 20mA)	TTL
INCHAN0_SDIN	AG24	Input Channel, Bit 0 and Serial Data in Serial Mode	TTL
INCHAN1_SCLK	AF24	Input Channel, Bit 1 and Serial Clock in Serial Mode	TTL
INCHAN2	AE24	Input Channel, Bit 2	TTL
INCHAN3	AH24	Input Channel, Bit 3	TTL
INCHAN4	AJ24	Input Channel, Bit 4	TTL
INCHAN5	AD27	Input Channel, Bit 5	TTL
INCHAN6	AD26	Input Channel, Bit 6	TTL
INITB	AJ6	INITB=0 Forces "Straight-Through" Program	TTL
ITC	AD29	Input Termination Control (GND = floating input termination, V <sub>CC</sub> = CML mode. See Table 7).	ANALOG
LOAD	AD28	Rising Edge Writes Data in Parallel and Burst Modes, See Figure 5 for Serial Mode	TTL
OUTCHAN0	F1	Output Channel, Bit 0	TTL
OUTCHAN1	F2	Output Channel, Bit 1	TTL
OUTCHAN2	F5	Output Channel, Bit 2	TTL
OUTCHAN3	F4	Output Channel, Bit 3	TTL
OUTCHAN4	F3	Output Channel, Bit 4	TTL
OUTCHAN5	A6	Output Channel, Bit 5	TTL
OUTCHAN6	B6	Output Channel, Bit 6	TTL
OUTCHAN7	E6	Output Channel, Bit 7 (burst mode only)	TTL
OUTCHAN8	D6	Output Channel, Bit 8 (burst mode only)	TTL
OUTCHAN9	C6	Output Channel, Bit 9 (burst mode only)	TTL
OUTCHAN10	A24	Output Channel, Bit 10 (burst mode only)	TTL
OUTCHAN11	B24	Output Channel, Bit 11 (burst mode only)	TTL
OUTCHAN12	E24	Output Channel, Bit 12 (burst mode only)	TTL
OUTCHAN13	D24	Output Channel, Bit 13 (burst mode only)	TTL

<i>Signal Name</i>	<i>Pin</i>	<i>Function</i>	<i>Level</i>
OUTCHAN14	C24	Output Channel, Bit 14 (burst mode only)	TTL
OUTCHAN15	F29	Output Channel, Bit 15 (burst mode only)	TTL
OUTCHAN16	F28	Output Channel, Bit 16 (burst mode only)	TTL
OUTCHAN17	F25	Output Channel, Bit 17 (burst mode only)	TTL
OUTCHAN18	F26	Output Channel, Bit 18 (burst mode only)	TTL
SDOUT	AG6	Serial Data Out for Serial Mode and Scan	TTL
SERIAL	AE6	SERIAL = 1 Sets Serial Mode	TTL
TERM_CTRL	AD5	Output Back-Termination Control (LOW = no back termination; HIGH = 50Ω back-termination to V <sub>CC</sub> . See Table 9).	TTL
<b>Power Supplies</b>			
VEE	C23	Common Negative Power Supply	GND
VEE	C7	Common Negative Power Supply	GND
VEE	R3	Common Negative Power Supply	GND
VEE	AG7	Common Negative Power Supply	GND
VEE	AG23	Common Negative Power Supply	GND
VEE	R27	Common Negative Power Supply	GND
VCC	A1	Positive Power Supply	2.5V
VCC	A2	Positive Power Supply	2.5V
VCC	A3	Positive Power Supply	2.5V
VCC	A4	Positive Power Supply	2.5V
VCC	A5	Positive Power Supply	2.5V
VCC	A25	Positive Power Supply	2.5V
VCC	A26	Positive Power Supply	2.5V
VCC	A27	Positive Power Supply	2.5V
VCC	A28	Positive Power Supply	2.5V
VCC	A29	Positive Power Supply	2.5V
VCC	AE1	Positive Power Supply	2.5V
VCC	AE2	Positive Power Supply	2.5V
VCC	AE25	Positive Power Supply	2.5V
VCC	AE26	Positive Power Supply	2.5V
VCC	AE27	Positive Power Supply	2.5V
VCC	AE28	Positive Power Supply	2.5V
VCC	AE29	Positive Power Supply	2.5V
VCC	AE3	Positive Power Supply	2.5V
VCC	AE4	Positive Power Supply	2.5V
VCC	AE5	Positive Power Supply	2.5V
VCC	AF1	Positive Power Supply	2.5V
VCC	AF2	Positive Power Supply	2.5V
VCC	AF25	Positive Power Supply	2.5V

## Preliminary Data Sheet

### VSC837

3.2Gb/s  
68x68 Crosspoint Switch

<i>Signal Name</i>	<i>Pin</i>	<i>Function</i>	<i>Level</i>
VCC	AF26	Positive Power Supply	2.5V
VCC	AF27	Positive Power Supply	2.5V
VCC	AF28	Positive Power Supply	2.5V
VCC	AF29	Positive Power Supply	2.5V
VCC	AF3	Positive Power Supply	2.5V
VCC	AF4	Positive Power Supply	2.5V
VCC	AF5	Positive Power Supply	2.5V
VCC	AG1	Positive Power Supply	2.5V
VCC	AG2	Positive Power Supply	2.5V
VCC	AG25	Positive Power Supply	2.5V
VCC	AG26	Positive Power Supply	2.5V
VCC	AG27	Positive Power Supply	2.5V
VCC	AG28	Positive Power Supply	2.5V
VCC	AG29	Positive Power Supply	2.5V
VCC	AG3	Positive Power Supply	2.5V
VCC	AG4	Positive Power Supply	2.5V
VCC	AG5	Positive Power Supply	2.5V
VCC	AH1	Positive Power Supply	2.5V
VCC	AH2	Positive Power Supply	2.5V
VCC	AH25	Positive Power Supply	2.5V
VCC	AH26	Positive Power Supply	2.5V
VCC	AH27	Positive Power Supply	2.5V
VCC	AH28	Positive Power Supply	2.5V
VCC	AH29	Positive Power Supply	2.5V
VCC	AH3	Positive Power Supply	2.5V
VCC	AH4	Positive Power Supply	2.5V
VCC	AH5	Positive Power Supply	2.5V
VCC	AJ1	Positive Power Supply	2.5V
VCC	AJ2	Positive Power Supply	2.5V
VCC	AJ25	Positive Power Supply	2.5V
VCC	AJ26	Positive Power Supply	2.5V
VCC	AJ27	Positive Power Supply	2.5V
VCC	AJ28	Positive Power Supply	2.5V
VCC	AJ29	Positive Power Supply	2.5V
VCC	AJ3	Positive Power Supply	2.5V
VCC	AJ4	Positive Power Supply	2.5V
VCC	AJ5	Positive Power Supply	2.5V
VCC	B1	Positive Power Supply	2.5V
VCC	B2	Positive Power Supply	2.5V

<i>Signal Name</i>	<i>Pin</i>	<i>Function</i>	<i>Level</i>
VCC	B25	Positive Power Supply	2.5V
VCC	B26	Positive Power Supply	2.5V
VCC	B27	Positive Power Supply	2.5V
VCC	B28	Positive Power Supply	2.5V
VCC	B29	Positive Power Supply	2.5V
VCC	B3	Positive Power Supply	2.5V
VCC	B4	Positive Power Supply	2.5V
VCC	B5	Positive Power Supply	2.5V
VCC	C1	Positive Power Supply	2.5V
VCC	C2	Positive Power Supply	2.5V
VCC	C25	Positive Power Supply	2.5V
VCC	C26	Positive Power Supply	2.5V
VCC	C27	Positive Power Supply	2.5V
VCC	C28	Positive Power Supply	2.5V
VCC	C29	Positive Power Supply	2.5V
VCC	C3	Positive Power Supply	2.5V
VCC	C4	Positive Power Supply	2.5V
VCC	C5	Positive Power Supply	2.5V
VCC	D1	Positive Power Supply	2.5V
VCC	D2	Positive Power Supply	2.5V
VCC	D25	Positive Power Supply	2.5V
VCC	D26	Positive Power Supply	2.5V
VCC	D27	Positive Power Supply	2.5V
VCC	D28	Positive Power Supply	2.5V
VCC	D29	Positive Power Supply	2.5V
VCC	D3	Positive Power Supply	2.5V
VCC	D4	Positive Power Supply	2.5V
VCC	D5	Positive Power Supply	2.5V
VCC	E1	Positive Power Supply	2.5V
VCC	E2	Positive Power Supply	2.5V
VCC	E25	Positive Power Supply	2.5V
VCC	E26	Positive Power Supply	2.5V
VCC	E27	Positive Power Supply	2.5V
VCC	E28	Positive Power Supply	2.5V
VCC	E29	Positive Power Supply	2.5V
VCC	E3	Positive Power Supply	2.5V
VCC	E4	Positive Power Supply	2.5V
VCC	E5	Positive Power Supply	2.5V
VEEP_T1	C22	Negative Power Supply for Inputs A4/AN4+A6/AN6	GND

## Preliminary Data Sheet

### VSC837

3.2Gb/s  
68x68 Crosspoint Switch

<i>Signal Name</i>	<i>Pin</i>	<i>Function</i>	<i>Level</i>
VEEP_T2	C21	Negative Power Supply for Inputs A8/AN8+A10/AN10	GND
VEEP_T3	C20	Negative Power Supply for Inputs A12/AN12+A14/AN14	GND
VEEP_T4	C19	Negative Power Supply for Inputs A16/AN16+A18/AN18	GND
VEEP_T5	C18	Negative Power Supply for Inputs A20/AN20+A22/AN22	GND
VEEP_T6	C17	Negative Power Supply for Inputs A24/AN24+A26/AN26	GND
VEEP_T7	C16	Negative Power Supply for Inputs A28/AN28+A30/AN30	GND
VEEP_T8	C15	Negative Power Supply for Inputs A32/AN32+A34/AN34	GND
VEEP_T9	C14	Negative Power Supply for Inputs A36/AN36+A38/AN38	GND
VEEP_T10	C13	Negative Power Supply for Inputs A40/AN40+A42/AN42	GND
VEEP_T11	C12	Negative Power Supply for Inputs A44/AN44+A46/AN46	GND
VEEP_T12	C11	Negative Power Supply for Inputs A48/AN48+A50/AN50	GND
VEEP_T13	C10	Negative Power Supply for Inputs A52/AN52+A54/AN54	GND
VEEP_T14	C9	Negative Power Supply for Inputs A56/AN56+A58/AN58	GND
VEEP_T15	C8	Negative Power Supply for Inputs A60/AN60+A62/AN62	GND
VEEP_B1	AG22	Negative Power Supply for Inputs A5/AN5+A7/AN7	GND
VEEP_B2	AG21	Negative Power Supply for Inputs A9/AN9+A11/AN11	GND
VEEP_B3	AG20	Negative Power Supply for Inputs A13/AN13+A15/AN15	GND
VEEP_B4	AG19	Negative Power Supply for Inputs A17/AN17+A19/AN19	GND
VEEP_B5	AG18	Negative Power Supply for Inputs A21/AN21+A23/AN23	GND
VEEP_B6	AG17	Negative Power Supply for Inputs A25/AN25+A27/AN27	GND
VEEP_B7	AG16	Negative Power Supply for Inputs A29/AN29+A31/AN31	GND
VEEP_B8	AG15	Negative Power Supply for Inputs A33/AN33+A35/AN35	GND
VEEP_B9	AG14	Negative Power Supply for Inputs A37/AN37+A39/AN39	GND
VEEP_B10	AG13	Negative Power Supply for Inputs A41/AN41+A43/AN43	GND
VEEP_B11	AG12	Negative Power Supply for Inputs A45/AN45+A47/AN47	GND
VEEP_B12	AG11	Negative Power Supply for Inputs A49/AN49+A51/AN51	GND
VEEP_B13	AG10	Negative Power Supply for Inputs A53/AN53+A55/AN55	GND
VEEP_B14	AG9	Negative Power Supply for Inputs A57/AN57+A59/AN59	GND
VEEP_B15	AG8	Negative Power Supply for Inputs A61/AN61+A63/AN63	GND
VEEP_L0	G3	Negative Power Supply for Outputs Y1/YN1+Y3/YN3	GND
VEEP_L1	H3	Negative Power Supply for Outputs Y5/YN5+Y7/YN7	GND
VEEP_L2	J3	Negative Power Supply for Outputs Y9/YN9+Y11/YN11	GND
VEEP_L3	K3	Negative Power Supply for Outputs Y13/YN13+Y15/YN15	GND
VEEP_L4	L3	Negative Power Supply for Outputs Y17/YN17+Y19/YN19	GND
VEEP_L5	M3	Negative Power Supply for Outputs Y21/YN21+Y23/YN23	GND
VEEP_L6	N3	Negative Power Supply for Outputs Y25/YN25+Y27/YN27	GND
VEEP_L7	P3	Negative Power Supply for Outputs Y29/YN29+Y31/YN31	GND
VEEP_L9	T3	Negative Power Supply for Outputs Y37/YN37+Y39/YN39	GND
VEEP_L10	U3	Negative Power Supply for Outputs Y41/YN41+Y43/YN43	GND

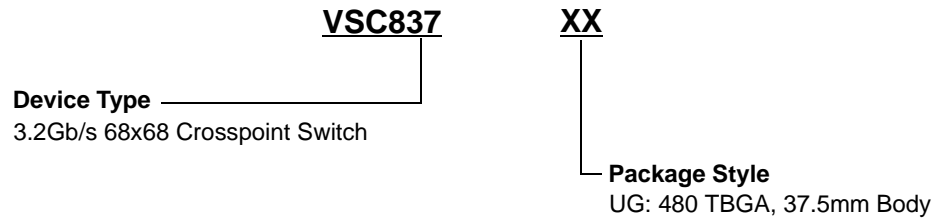
<i>Signal Name</i>	<i>Pin</i>	<i>Function</i>	<i>Level</i>
VEEP_L11	V3	Negative Power Supply for Outputs Y45/YN45+Y47/YN47	GND
VEEP_L12	W3	Negative Power Supply for Outputs Y49/YN49+Y51/YN51	GND
VEEP_L13	Y3	Negative Power Supply for Outputs Y53/YN53+Y55/YN55	GND
VEEP_L14	AA3	Negative Power Supply for Outputs Y57/YN57+Y59/YN59	GND
VEEP_L15	AB3	Negative Power Supply for Outputs Y61/YN61+Y63/YN63	GND
VEEP_L16	AC3	Negative Power Supply for Outputs Y65/YN65+Y67/YN67	GND
VEEP_R0	G27	Negative Power Supply for Outputs Y0/YN0+Y2/YN2	GND
VEEP_R1	H27	Negative Power Supply for Outputs Y4/YN4+Y6/YN6	GND
VEEP_R2	J27	Negative Power Supply for Outputs Y8/YN8+Y10/YN10	GND
VEEP_R3	K27	Negative Power Supply for Outputs Y12/YN12+Y14/YN14	GND
VEEP_R4	L27	Negative Power Supply for Outputs Y16/YN16+Y18/YN18	GND
VEEP_R5	M27	Negative Power Supply for Outputs Y20/YN20+Y22/YN22	GND
VEEP_R6	N27	Negative Power Supply for Outputs Y24/YN24+Y26/YN26	GND
VEEP_R7	P27	Negative Power Supply for Outputs Y28/YN28+Y30/YN30	GND
VEEP_R9	T27	Negative Power Supply for Outputs Y36/YN36+Y38/YN38	GND
VEEP_R10	U27	Negative Power Supply for Outputs Y40/YN40+Y42/YN42	GND
VEEP_R11	V27	Negative Power Supply for Outputs Y44/YN44+Y46/YN46	GND
VEEP_R12	W27	Negative Power Supply for Outputs Y48/YN48+Y50/YN50	GND
VEEP_R13	Y27	Negative Power Supply for Outputs Y52/YN52+Y54/YN54	GND
VEEP_R14	AA27	Negative Power Supply for Outputs Y56/YN56+Y58/YN58	GND
VEEP_R15	AB27	Negative Power Supply for Outputs Y60/YN60+Y62/YN62	GND
VEEP_R16	AC27	Negative Power Supply for Outputs Y64/YN64+Y66/YN66	GND





## Ordering Information

The order number for this product is formed by a combination of the device type and package type.



## Notice

Vitesse Semiconductor Corporation (“Vitesse”) provides this document for informational purposes only. This document contains pre-production information about Vitesse products in their concept, development and/or testing phase. All information in this document, including descriptions of features, functions, performance, technical specifications and availability, is subject to change without notice at any time. Nothing contained in this document shall be construed as extending any warranty or promise, express or implied, that any Vitesse product will be available as described or will be suitable for or will accomplish any particular task.

Vitesse products are not intended for use in life support appliances, devices or systems. Use of a Vitesse product in such applications without written consent is prohibited.