

6-13 GHz Low Noise Amplifier TGA8399B-EPU

Key Features and Performance

- 3 Stage LNA 0.25um pHEMT Technology
- 6-13 GHz Frequency Range
- 1.75 dB Typical Noise Figure Midband
- 25 dB Nominal Gain
- High Input Power Handling: ~ 20dBm
- Balanced Input for Low VSWR
- 5V @ 65mA Self Bias

Primary Applications

- Point-to-Point Radio

Release Status

- Engineering Prototype Unit (EPU) samples available

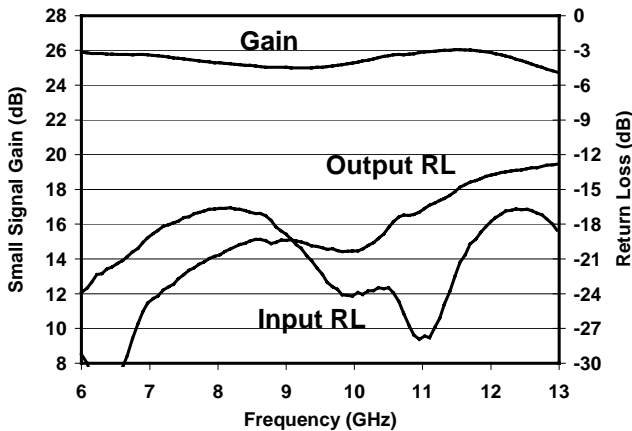

Typical Measured Small Signal Gain & RL

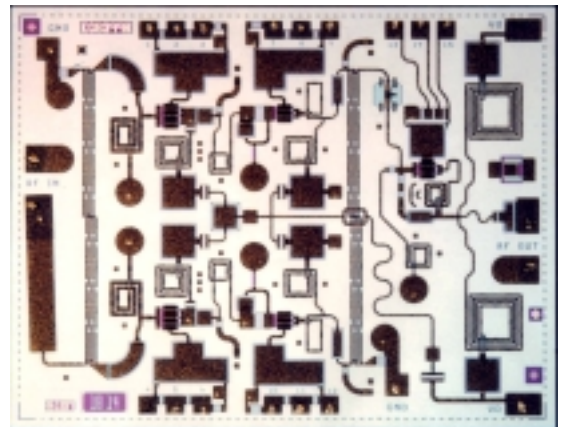

Chip Dimensions 3.07mm x 2.41mm x 0.152mm

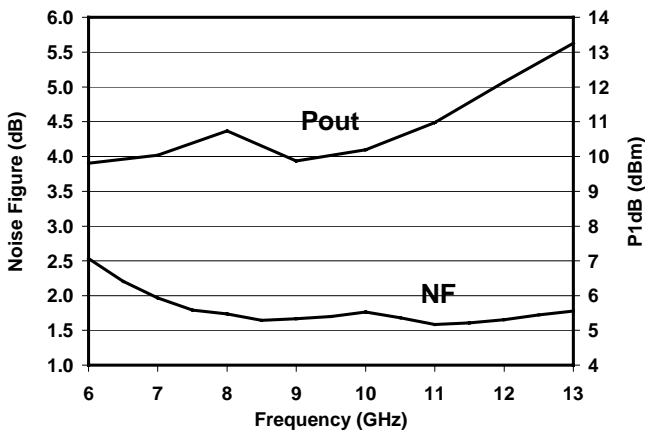

Typical Measured NF and Pout

Note: Devices designated as EPU are typically early in their characterization process prior to finalizing all electrical and process specifications.

TA8399B Performance vs Temperature

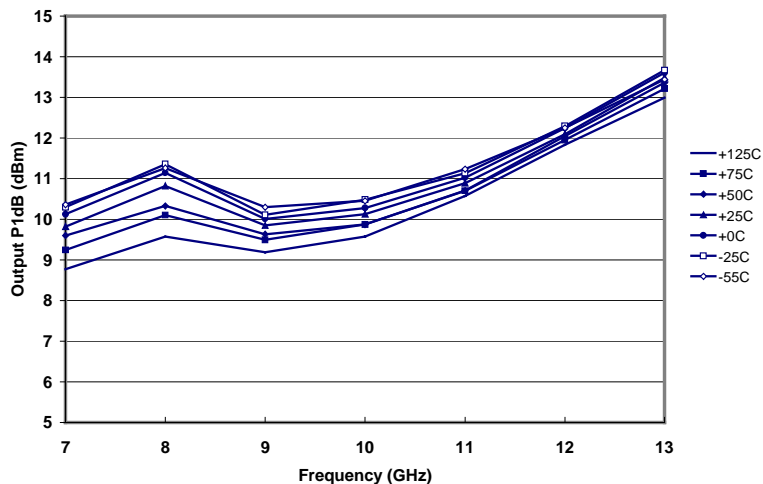
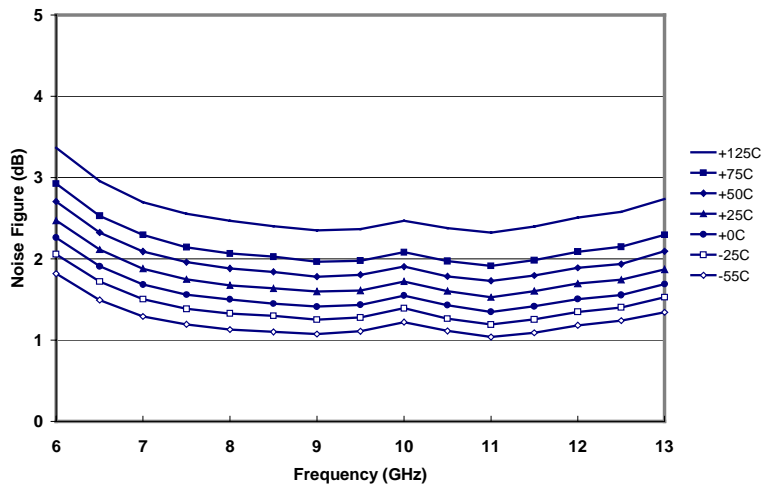
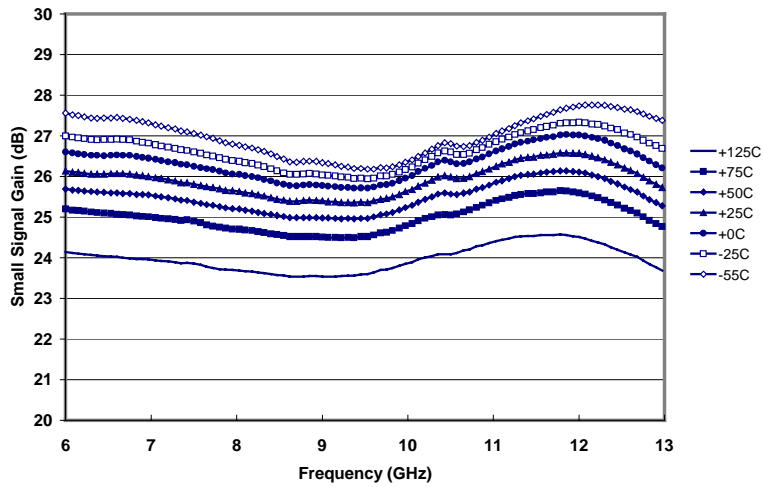

Note: Devices designated as EPU are typically early in their characterization process prior to finalizing all electrical and process specifications.



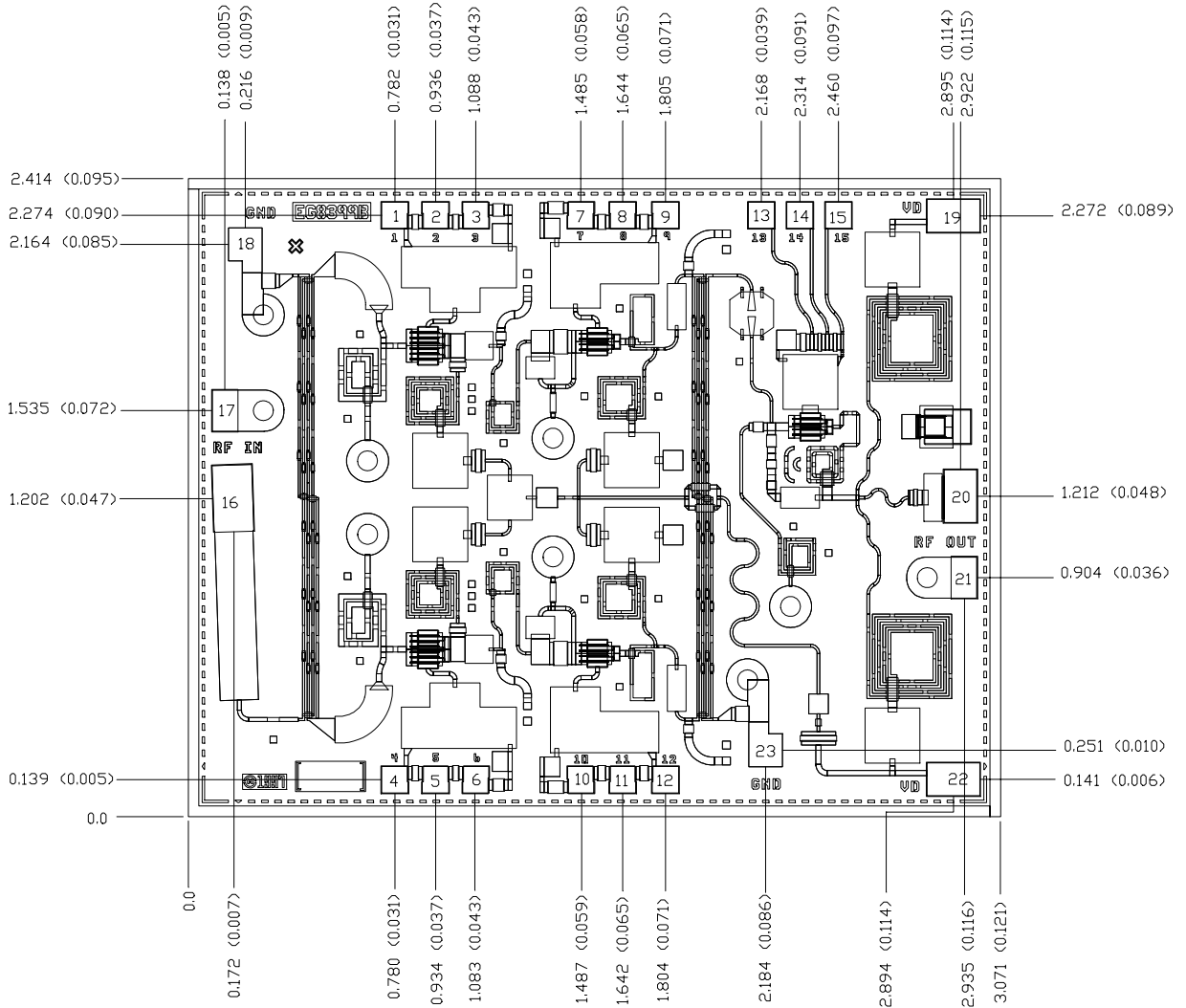

Units: millimeters (inches)

Thickness: 0.1524 (0.006) (reference only)

Chip edge to bond pad dimensions are shown to center of bond pad

Chip size tolerance: +/- 0.051 (0.002)

Bond Pad #1~#15 (R1~R15)	0.100 x 0.100 (0.004 x 0.004)
Bond Pad #16 (RF Input)	0.152 x 0.252 (0.006 x 0.010)
Bond Pad #17 (GND)	0.100 x 0.161 (0.004 x 0.006)
Bond Pad #18 (GND)	0.125 x 0.128 (0.005 x 0.005)
Bond Pad #19 (VDD)	0.125 x 0.200 (0.005 x 0.008)
Bond Pad #20 (RF Output)	0.125 x 0.200 (0.005 x 0.008)
Bond Pad #21 (GND)	0.100 x 0.161 (0.004 x 0.006)
Bond Pad #22 (VDD)	0.125 x 0.200 (0.005 x 0.008)
Bond Pad #23 (GND)	0.125 x 0.128 (0.005 x 0.005)

Note: Devices designated as EPU are typically early in their characterization process prior to finalizing all electrical and process specifications.

Recommended Assembly Layout

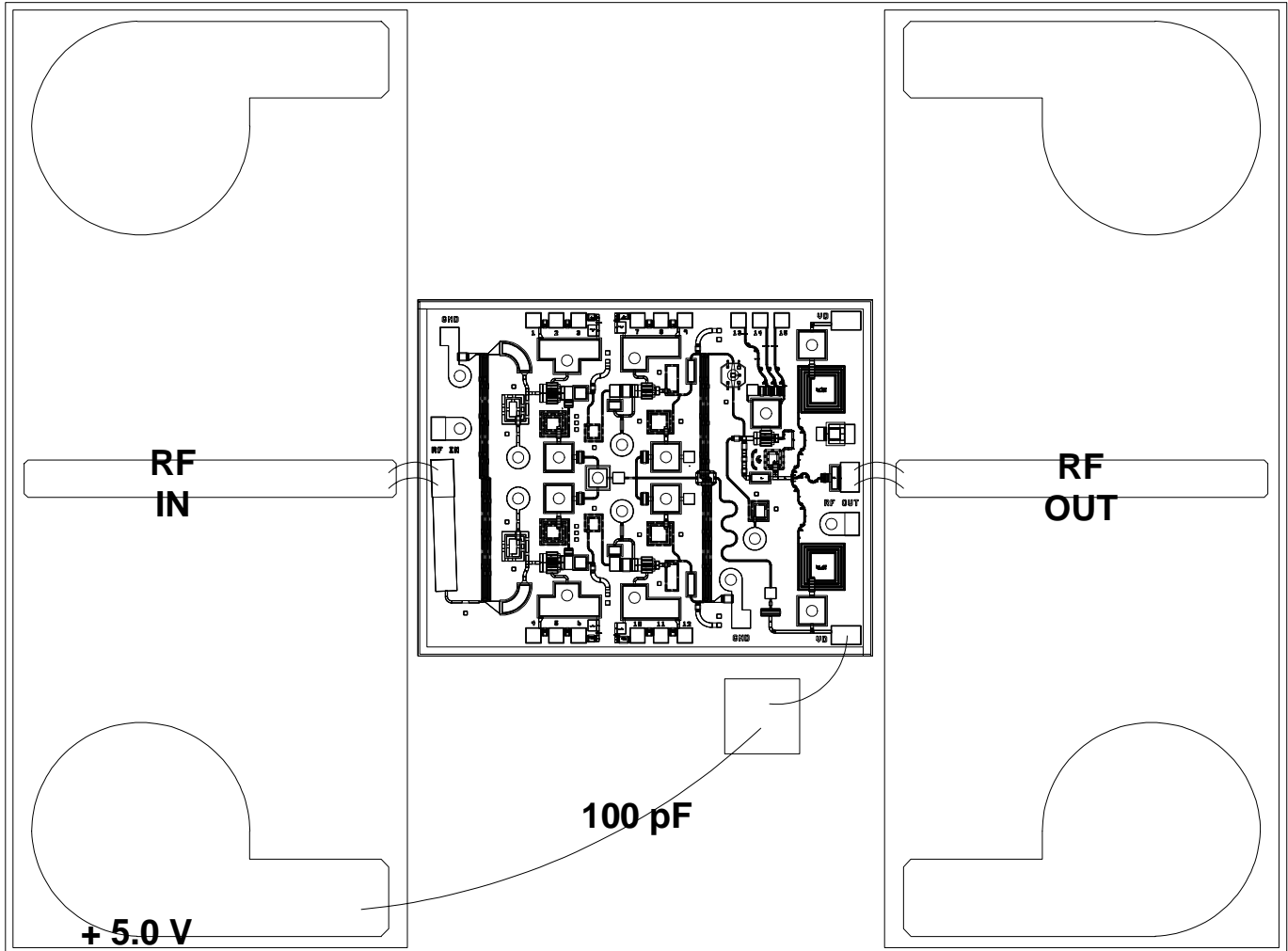

Note: Devices designated as EPU are typically early in their characterization process prior to finalizing all electrical and process specifications.

