



## N-Channel Logic Level Enhancement Mode Field Effect Transistor

PRODUCT SUMMARY		
V <sub>DSS</sub>	ID	R <sub>DS(on)</sub> (mΩ) TYP
30V	65A	8 @ V <sub>GS</sub> = 10V
		12 @ V <sub>GS</sub> = 4.5V

## FEATURES

- Super high dense cell design for extremely low R<sub>DS(ON)</sub>.
- High power and current handling capability.
- TO-220 & TO-263 package.

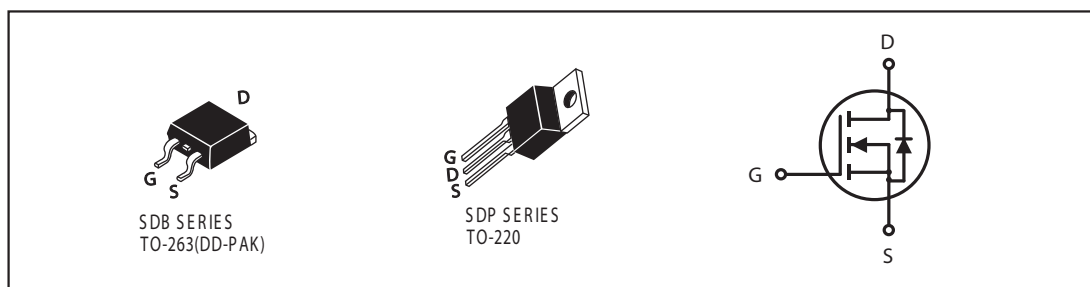
ABSOLUTE MAXIMUM RATINGS (T<sub>C</sub>=25°C unless otherwise noted)

Parameter	Symbol	Limit	Unit
Drain-Source Voltage	V <sub>DS</sub>	30	V
Gate-Source Voltage	V <sub>GS</sub>	±20	V
Drain Current-Continuous @ T <sub>J</sub> =125°C -Pulsed <sup>a</sup>	I <sub>D</sub>	65	A
	I <sub>DM</sub>	195	A
Drain-Source Diode Forward Current	I <sub>S</sub>	65	A
Maximum Power Dissipation @ T <sub>C</sub> =25°C Derate above 25°C	P <sub>D</sub>	75	W
		0.5	W/°C
Operating and Storage Temperature Range	T <sub>J</sub> , T <sub>STG</sub>	-65 to 175	°C

## THERMAL CHARACTERISTICS

Thermal Resistance, Junction-to-Case	R <sub>θJC</sub>	2	°C/W
Thermal Resistance, Junction-to-Ambient	R <sub>θJA</sub>	62.5	°C/W

# SDP/B65N03L

## ELECTRICAL CHARACTERISTICS (Tc=25°C unless otherwise noted)

Parameter	Symbol	Condition	Min	Typ <sup>c</sup>	Max	Unit
<b>OFF CHARACTERISTICS</b>						
Drain-Source Breakdown Voltage	BV <sub>DSS</sub>	V <sub>GS</sub> =0V, I <sub>D</sub> =250uA	30			V
Zero Gate Voltage Drain Current	I <sub>DSS</sub>	V <sub>DS</sub> =24V, V <sub>GS</sub> =0V			10	uA
Gate-Body Leakage	I <sub>GSS</sub>	V <sub>GS</sub> =±20V, V <sub>DS</sub> =0V			±100	nA
<b>ON CHARACTERISTICS <sup>a</sup></b>						
Gate Threshold Voltage	V <sub>GS(th)</sub>	V <sub>DS</sub> =V <sub>GS</sub> , I <sub>D</sub> =250uA	1	1.5	3	V
Drain-Source On-State Resistance	R <sub>DS(ON)</sub>	V <sub>GS</sub> =10V, I <sub>D</sub> =26A		8	9	m ohm
		V <sub>GS</sub> =4.5V, I <sub>D</sub> =21A		12	15	m ohm
On-State Drain Current	I <sub>D(ON)</sub>	V <sub>DS</sub> =10V, V <sub>GS</sub> =10V	65			A
Forward Transconductance	g <sub>FS</sub>	V <sub>DS</sub> =10V, I <sub>D</sub> =26A		38		S
<b>DYNAMIC CHARACTERISTICS <sup>b</sup></b>						
Input Capacitance	C <sub>ISS</sub>	V <sub>DS</sub> =15V, V <sub>GS</sub> =0V f=1.0MHz		1350		pF
Output Capacitance	C <sub>OSS</sub>			625		pF
Reverse Transfer Capacitance	C <sub>RSS</sub>			190		pF
<b>SWITCHING CHARACTERISTICS <sup>b</sup></b>						
Turn-On Delay Time	t <sub>D(ON)</sub>	V <sub>DD</sub> =15V, I <sub>D</sub> =1A, V <sub>GS</sub> =10V R <sub>GEN</sub> =6 ohm		30		ns
Rise Time	t <sub>r</sub>			32		ns
Turn-Off Delay Time	t <sub>D(OFF)</sub>			132		ns
Fall Time	t <sub>f</sub>			30		ns
Total Gate Charge	Q <sub>g</sub>	V <sub>DS</sub> =10V, I <sub>D</sub> =65A, V <sub>GS</sub> =10V		41	50	nC
		V <sub>DS</sub> =10V, I <sub>D</sub> =65A, V <sub>GS</sub> =4.5V		20.5	24.5	nC
Gate-Source Charge	Q <sub>gs</sub>	V <sub>DS</sub> =10V, I <sub>D</sub> =65A, V <sub>GS</sub> =10V		6.9		nC
Gate-Drain Charge	Q <sub>gd</sub>			5.8		nC

# SDP/B65N03L

## ELECTRICAL CHARACTERISTICS ( $T_c=25^{\circ}\text{C}$ unless otherwise noted)

Parameter	Symbol	Condition	Min	Typ	Max	Unit
<b>DRAIN-SOURCE DIODE CHARACTERISTICS <sup>a</sup></b>						
Diode Forward Voltage	$V_{SD}$	$V_{GS} = 0\text{V}, I_s = 26\text{A}$		0.9	1.3	V

### Notes

- a. Pulse Test: Pulse Width  $\leq 300\mu\text{s}$ , Duty Cycle  $\leq 2\%$ .
- b. Guaranteed by design, not subject to production testing.

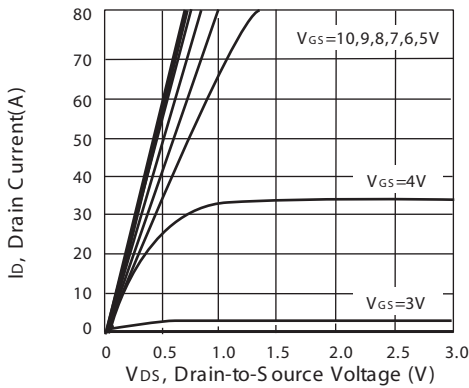

Figure 1. Output Characteristics

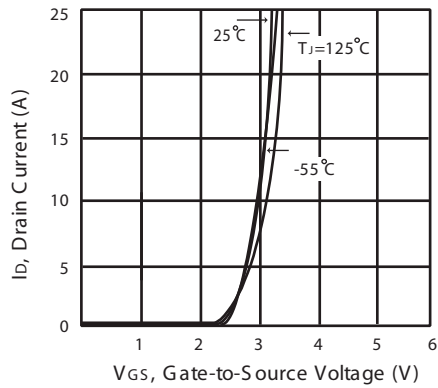

Figure 2. Transfer Characteristics

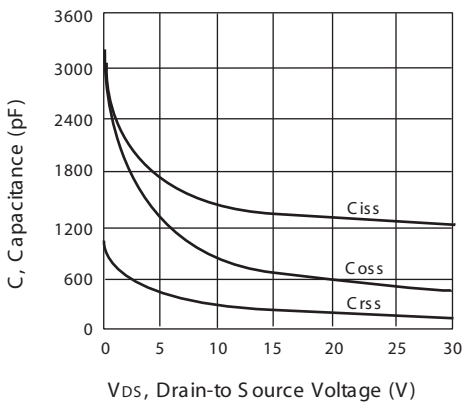

Figure 3. Capacitance

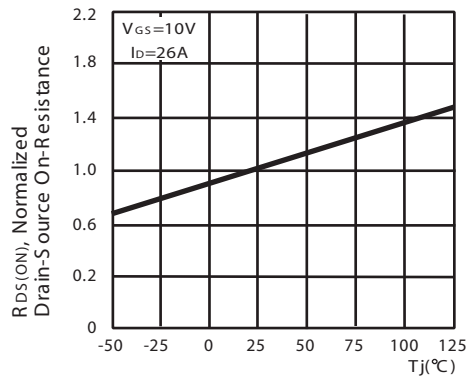

Figure 4. On-Resistance Variation with Temperature

# SDP/B65N03L

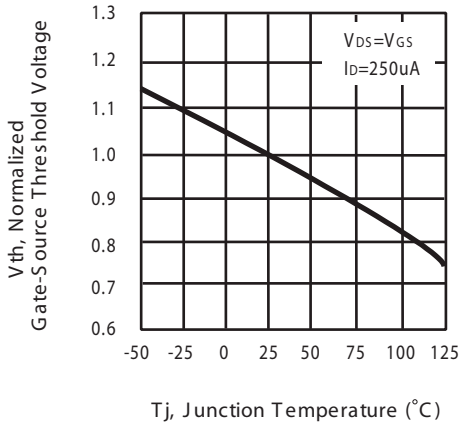

Figure 5. Gate Threshold Variation with Temperature

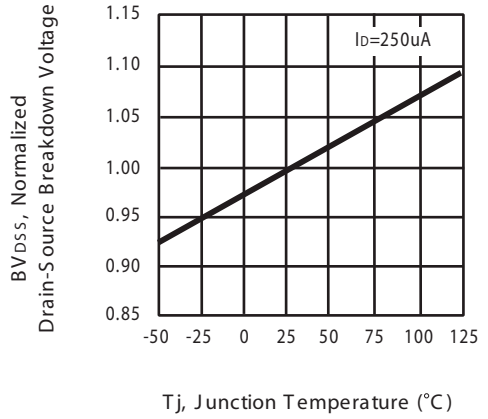

Figure 6. Breakdown Voltage Variation with Temperature

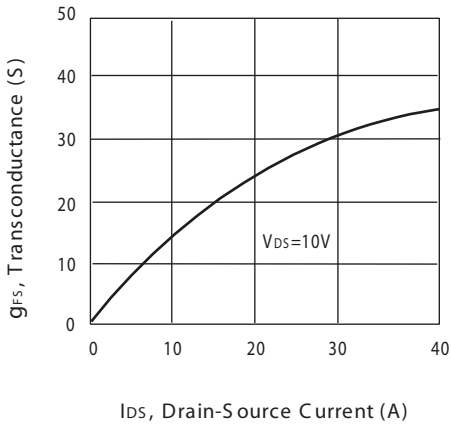

Figure 7. Transconductance Variation with Drain Current

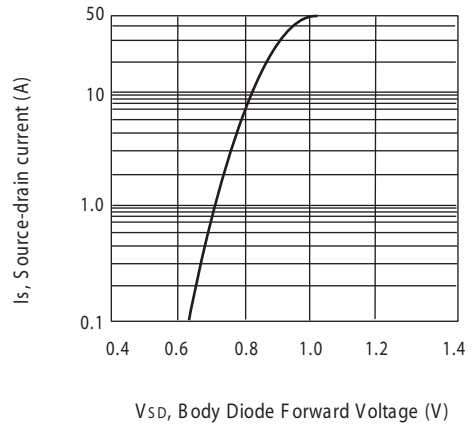

Figure 8. Body Diode Forward Voltage Variation with Source Current

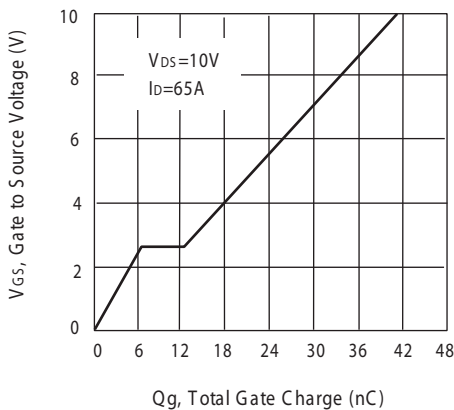

Figure 9. Gate Charge

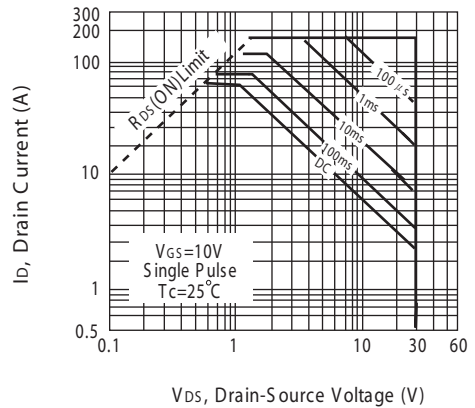

Figure 10. Maximum Safe Operating Area

# SDP/B65N03L

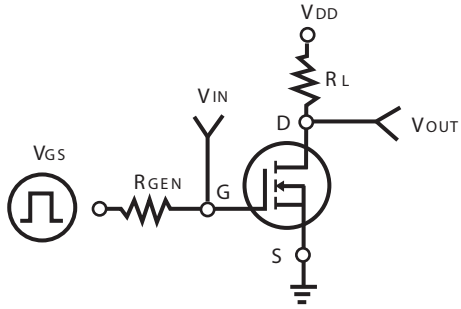

Figure 11. Switching Test Circuit

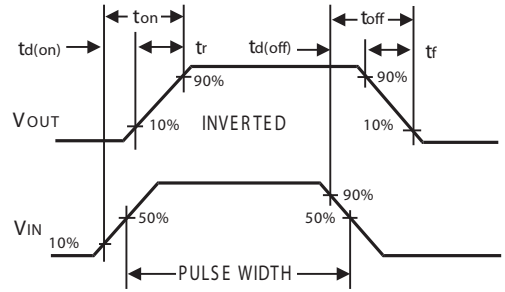

Figure 12. Switching Waveforms

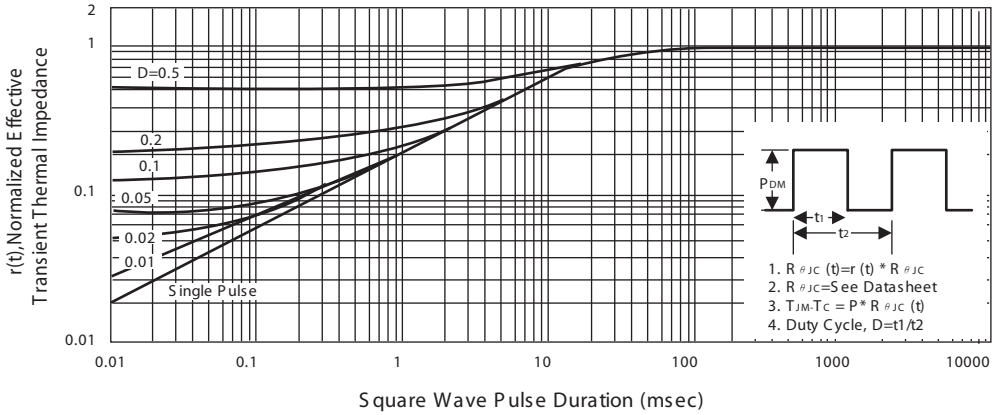

Figure 13. Normalized Thermal Transient Impedance Curve