

POWER MOS V®

Power MOS V® is a new generation of high voltage N-Channel enhancement mode power MOSFETs. This new technology minimizes the JFET effect, increases packing density and reduces the on-resistance. Power MOS V® also achieves faster switching speeds through optimized gate layout.

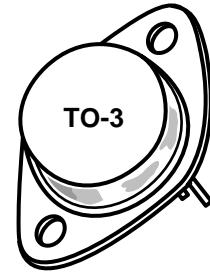

- Faster Switching
- Lower Leakage
- 100% Avalanche Tested
- Popular TO-3 Package

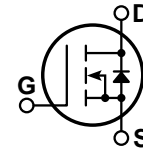

MAXIMUM RATINGS

All Ratings: $T_C = 25^\circ\text{C}$ unless otherwise specified.

| Symbol | Parameter | APT1001R1AVR | UNIT |
|----------------|--|--------------|---------------------|
| V_{DSS} | Drain-Source Voltage | 1000 | Volts |
| I_D | Continuous Drain Current @ $T_C = 25^\circ\text{C}$ | 9 | Amps |
| I_{DM} | Pulsed Drain Current ^① | 36 | |
| V_{GS} | Gate-Source Voltage Continuous | ± 30 | Volts |
| V_{GSM} | Gate-Source Voltage Transient | ± 40 | |
| P_D | Total Power Dissipation @ $T_C = 25^\circ\text{C}$ | 200 | Watts |
| | Linear Derating Factor | 1.6 | W/ $^\circ\text{C}$ |
| T_J, T_{STG} | Operating and Storage Junction Temperature Range | -55 to 150 | $^\circ\text{C}$ |
| T_L | Lead Temperature: 0.063" from Case for 10 Sec. | 300 | |
| I_{AR} | Avalanche Current ^① (Repetitive and Non-Repetitive) | 9 | Amps |
| E_{AR} | Repetitive Avalanche Energy ^① | 30 | mJ |
| E_{AS} | Single Pulse Avalanche Energy ^④ | 1210 | |

STATIC ELECTRICAL CHARACTERISTICS

| Symbol | Characteristic / Test Conditions | MIN | TYP | MAX | UNIT |
|--------------|--|------|-----|-----------|---------------|
| BV_{DSS} | Drain-Source Breakdown Voltage ($V_{GS} = 0V, I_D = 250\mu\text{A}$) | 1000 | | | Volts |
| $I_{D(on)}$ | On State Drain Current ^② ($V_{DS} > I_{D(on)} \times R_{DS(on)}$ Max, $V_{GS} = 10V$) | 9 | | | Amps |
| $R_{DS(on)}$ | Drain-Source On-State Resistance ^② ($V_{GS} = 10V, 0.5 I_{D[Cont.]}$) | | | 1.100 | Ohms |
| I_{DSS} | Zero Gate Voltage Drain Current ($V_{DS} = V_{DSS}, V_{GS} = 0V$) | | | 25 | μA |
| | Zero Gate Voltage Drain Current ($V_{DS} = 0.8 V_{DSS}, V_{GS} = 0V, T_C = 125^\circ\text{C}$) | | | 250 | |
| I_{GSS} | Gate-Source Leakage Current ($V_{GS} = \pm 30V, V_{DS} = 0V$) | | | ± 100 | nA |
| $V_{GS(th)}$ | Gate Threshold Voltage ($V_{DS} = V_{GS}, I_D = 1.0\text{mA}$) | 2 | | 4 | Volts |

 **CAUTION:** These Devices are Sensitive to Electrostatic Discharge. Proper Handling Procedures Should Be Followed.

USA
405 S.W. Columbia Street

EUROPE
Avenue J.F. Kennedy Bât B4 Parc Cadéra Nord

APT Website - <http://www.advancedpower.com>

Bend, Oregon 97702-1035

Phone: (541) 382-8028

FAX: (541) 388-0364

F-33700 Merignac - France

Phone: (33) 5 57 92 15 15

FAX: (33) 5 56 47 97 61

DYNAMIC CHARACTERISTICS

APT1001R1AVR

| Symbol | Characteristic | Test Conditions | MIN | TYP | MAX | UNIT |
|--------------|------------------------------|--|-----|------|------|------|
| C_{iss} | Input Capacitance | $V_{GS} = 0V$ $V_{DS} = 25V$ $f = 1\text{ MHz}$ | | 3050 | 3660 | pF |
| C_{oss} | Output Capacitance | | | 280 | 390 | |
| C_{rss} | Reverse Transfer Capacitance | | | 135 | 200 | |
| Q_g | Total Gate Charge ③ | $V_{GS} = 10V$ $V_{DD} = 0.5 V_{DSS}$ $I_D = I_{D[Cont.]} @ 25^\circ C$ | | 150 | 225 | nC |
| Q_{gs} | Gate-Source Charge | | | 16 | 24 | |
| Q_{gd} | Gate-Drain ("Miller") Charge | | | 70 | 105 | |
| $t_{d(on)}$ | Turn-on Delay Time | $V_{GS} = 15V$ $V_{DD} = 0.5 V_{DSS}$ $I_D = I_{D[Cont.]} @ 25^\circ C$ $R_G = 1.6\Omega$ | | 12 | 24 | ns |
| t_r | Rise Time | | | 11 | 22 | |
| $t_{d(off)}$ | Turn-off Delay Time | | | 55 | 85 | |
| t_f | Fall Time | | | 12 | 24 | |

SOURCE-DRAIN DIODE RATINGS AND CHARACTERISTICS

| Symbol | Characteristic / Test Conditions | MIN | TYP | MAX | UNIT |
|----------|---|-----|-----|-----|---------|
| I_S | Continuous Source Current (Body Diode) | | | 9 | Amps |
| I_{SM} | Pulsed Source Current ① (Body Diode) | | | 36 | |
| V_{SD} | Diode Forward Voltage ② ($V_{GS} = 0V, I_S = -I_{D[Cont.]}$) | | | 1.3 | Volts |
| t_{rr} | Reverse Recovery Time ($I_S = -I_{D[Cont.]}, di_S/dt = 100A/\mu s$) | | 700 | | ns |
| Q_{rr} | Reverse Recovery Charge ($I_S = -I_{D[Cont.]}, di_S/dt = 100A/\mu s$) | | 9 | | μC |

THERMAL CHARACTERISTICS

| Symbol | Characteristic | MIN | TYP | MAX | UNIT |
|-----------------|---------------------|-----|-----|------|--------------|
| $R_{\theta JC}$ | Junction to Case | | | 0.62 | $^\circ C/W$ |
| $R_{\theta JA}$ | Junction to Ambient | | | 30 | |

- ① Repetitive Rating: Pulse width limited by maximum junction temperature.
- ② Pulse Test: Pulse width < 380 μs , Duty Cycle < 2%
- ③ See MIL-STD-750 Method 3471
- ④ Starting $T_j = +25^\circ C$, $L = 29.88mH$, $R_G = 25\Omega$, Peak $I_L = 9A$

APT Reserves the right to change, without notice, the specifications and information contained herein.

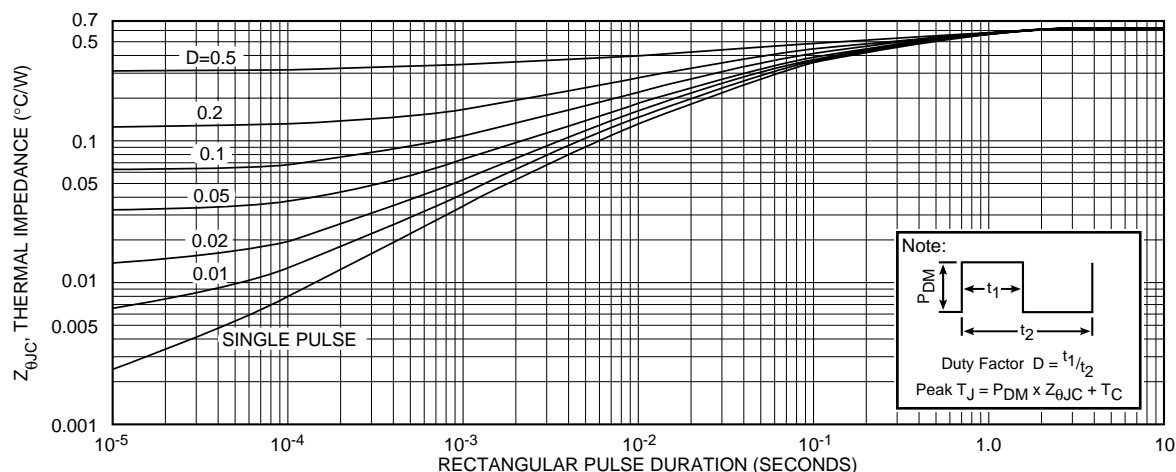

FIGURE 1, MAXIMUM EFFECTIVE TRANSIENT THERMAL IMPEDANCE, JUNCTION-TO-CASE vs PULSE DURATION

APT1001R1AVR

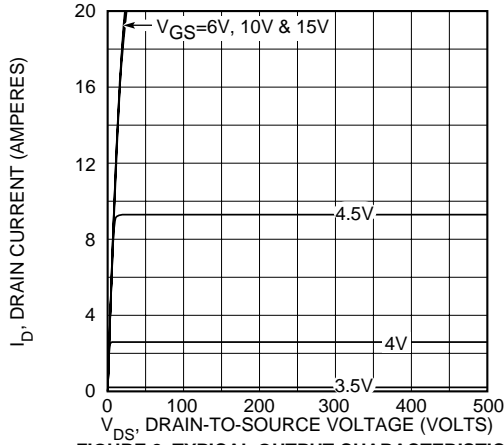

FIGURE 2, TYPICAL OUTPUT CHARACTERISTICS

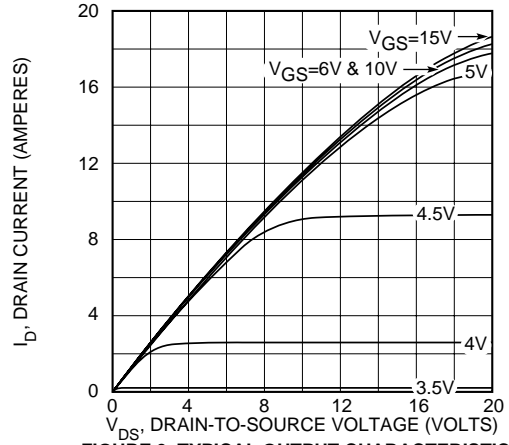

FIGURE 3, TYPICAL OUTPUT CHARACTERISTICS

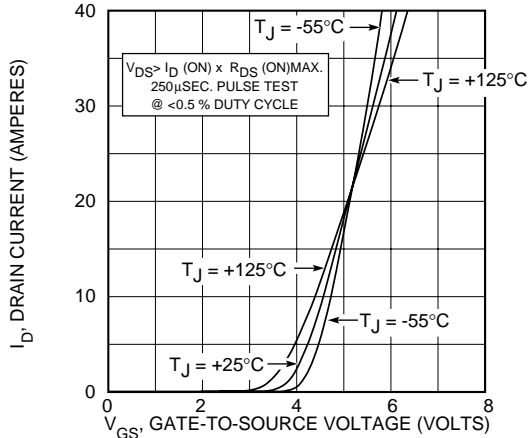

FIGURE 4, TYPICAL TRANSFER CHARACTERISTICS

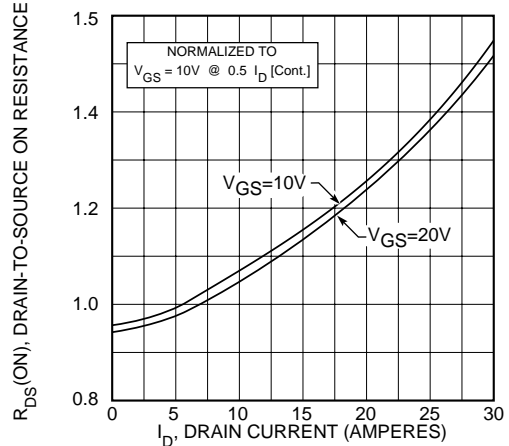

FIGURE 5, R_DS(ON) vs DRAIN CURRENT

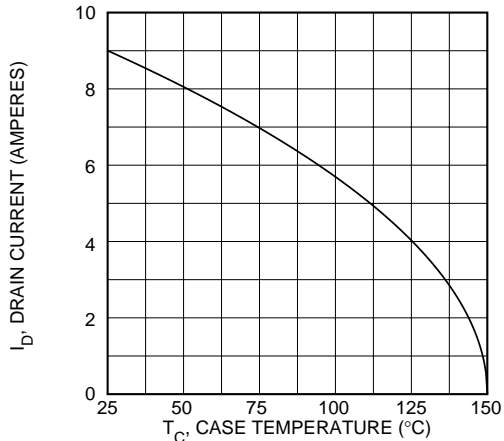

FIGURE 6, MAXIMUM DRAIN CURRENT vs CASE TEMPERATURE

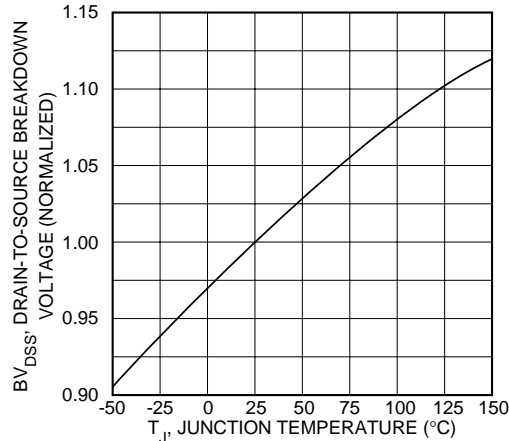

FIGURE 7, BREAKDOWN VOLTAGE vs TEMPERATURE

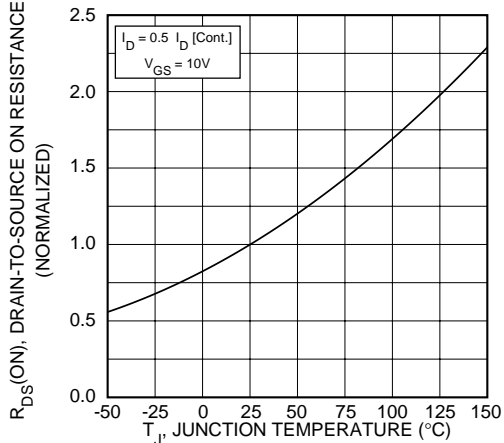

FIGURE 8, ON-RESISTANCE vs. TEMPERATURE

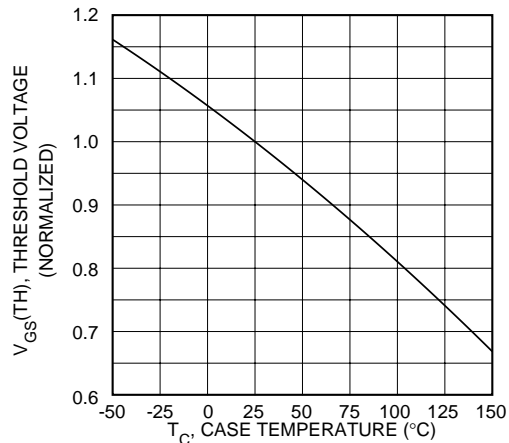

FIGURE 9, THRESHOLD VOLTAGE vs TEMPERATURE

APT1001R1AVR

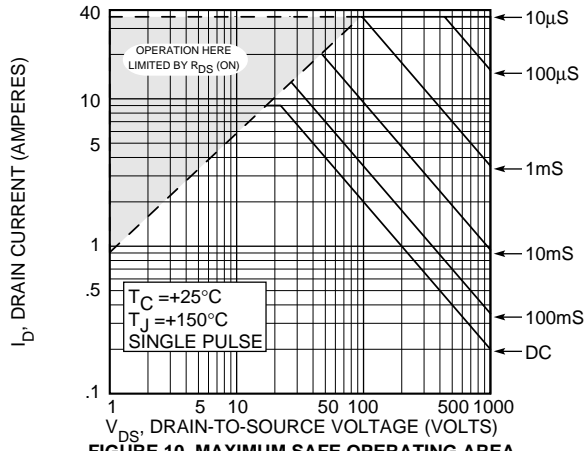

FIGURE 10, MAXIMUM SAFE OPERATING AREA

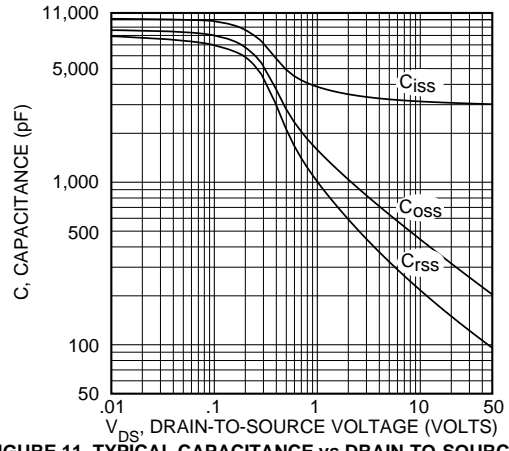

FIGURE 11, TYPICAL CAPACITANCE vs DRAIN-TO-SOURCE VOLTAGE

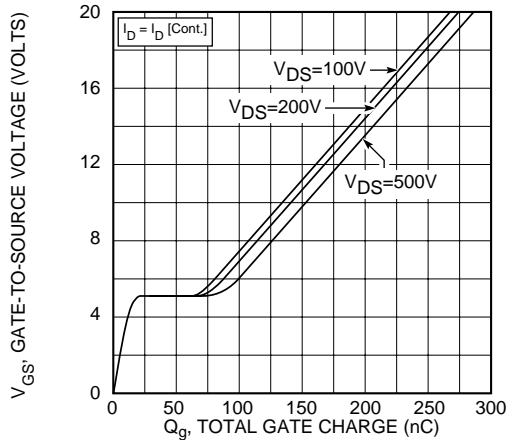

FIGURE 12, GATE CHARGES vs GATE-TO-SOURCE VOLTAGE

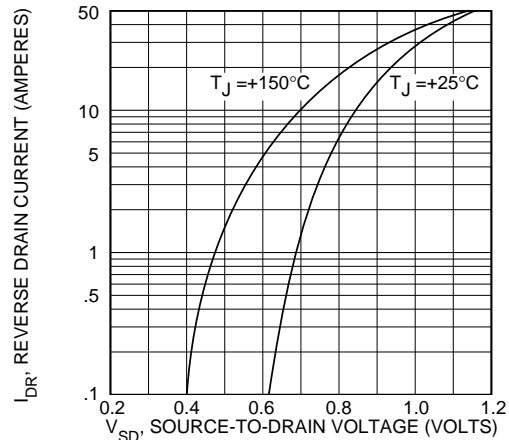
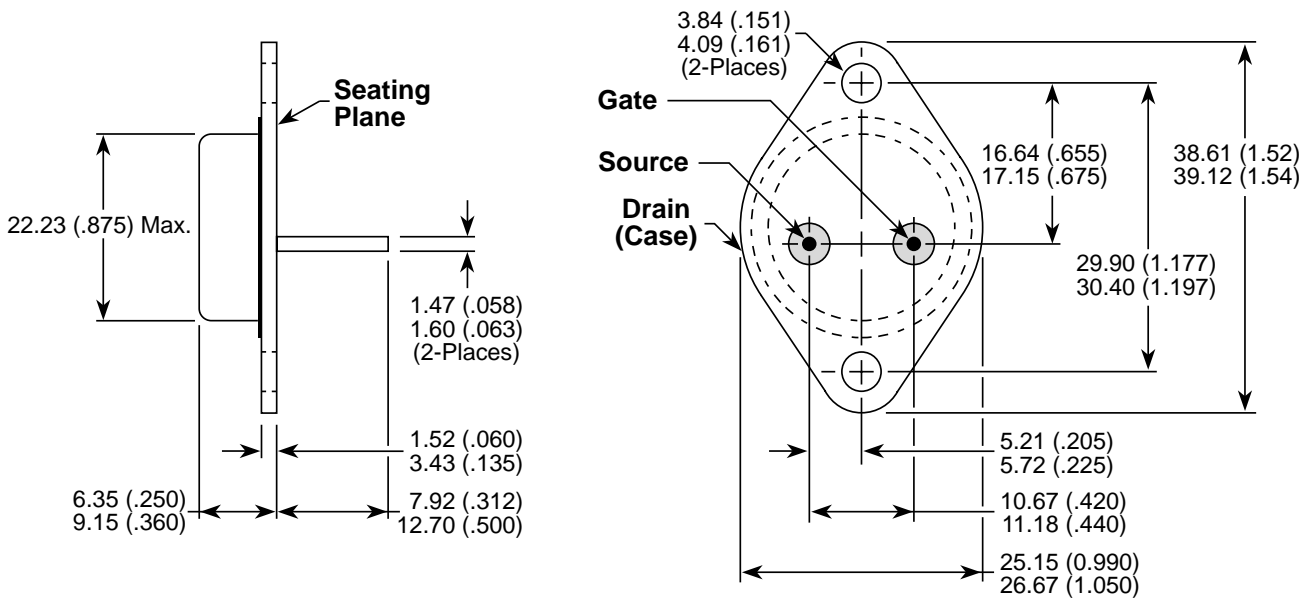

FIGURE 13, TYPICAL SOURCE-DRAIN DIODE FORWARD VOLTAGE

TO-3 (TO-204AE) Package Outline



Dimensions in Millimeters and (Inches)