

Low Power Economy BiCMOS Current Mode PWM

FEATURES

- 100µA Typical Starting Supply Current
- 500µA Typical Operating Supply Current
- Operation to 1MHz
- Internal Soft Start
- Internal Fault Soft Start
- Internal Leading-Edge Blanking of the Current Sense Signal
- 1 Amp Totem-Pole Output
- 70ns Typical Response from Current-Sense to Gate Drive Output
- 1.5% Tolerance Voltage Reference
- Same Pinout as UCC3802, UC3842, and UC3842A

DESCRIPTION

The UCC3813-0/-1/-2/-3/-4/-5 family of high-speed, low-power integrated circuits contain all of the control and drive components required for off-line and DC-to-DC fixed frequency current-mode switching power supplies with minimal parts count.

These devices have the same pin configuration as the UC3842/3/4/5 family, and also offer the added features of internal full-cycle soft start and internal leading-edge blanking of the current-sense input.

The UCC3813-0/-1/-2/-3/-4/-5 family offers a variety of package options, temperature range options, choice of maximum duty cycle, and choice of critical voltage levels. Lower reference parts such as the UCC3813-3 and UCC3813-5 fit best into battery operated systems, while the higher reference and the higher UVLO hysteresis of the UCC3813-2 and UCC3813-4 make these ideal choices for use in off-line power supplies.

The UCC2813-x series is specified for operation from -40°C to +85°C and the UCC3813-x series is specified for operation from 0°C to +70°C.

ORDERING INFORMATION

Part Number	Maximum Duty Cycle	Reference Voltage	Turn-On Threshold	Turn-Off Threshold
UCCx813-0	100%	5V	7.2V	6.9V
UCCx813-1	50%	5V	9.4V	7.4V
UCCx813-2	100%	5V	12.5V	8.3V
UCCx813-3	100%	4V	4.1V	3.6V
UCCx813-4	50%	5V	12.5V	8.3V
UCCx813-5	50%	4V	4.1V	3.6V

BLOCK DIAGRAM

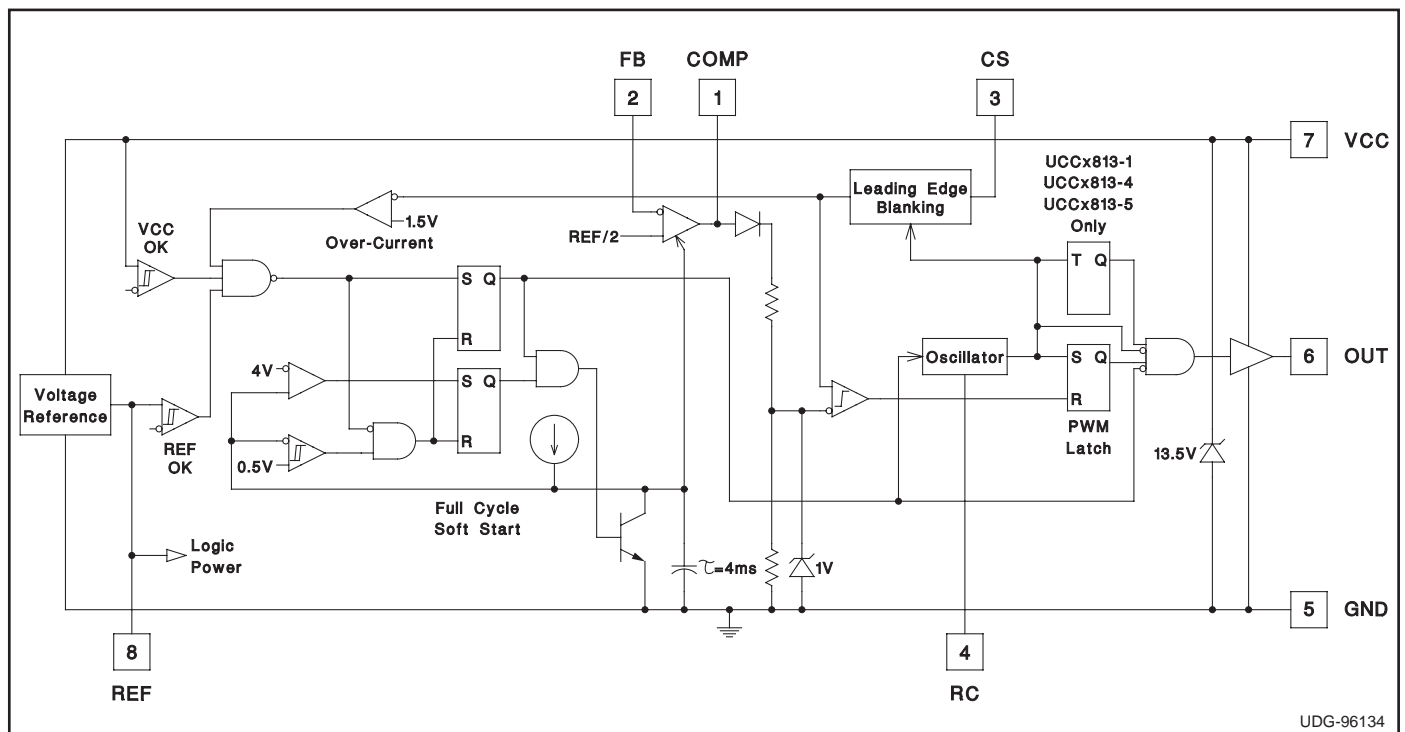

ABSOLUTE MAXIMUM RATINGS (Note 1)

VCC Voltage (Note 2)	12.0V
VCC Current	30.0mA
OUT Current	1.0A
OUT Energy (Capacitive Load)	20.0μJ
Analog Inputs (FB, CS)	-0.3V to 6.3V
Power Dissipation at T _A < +25°C (N Package)	1.0W
Power Dissipation at T _A < +25°C (D Package)	0.65W
Storage Temperature	-65 C to +150°C
Junction Temperature	-55 C to +150°C
Lead Temperature (Soldering, 10 Seconds)	+300°C

Note 1: All voltages are with respect to GND. All currents are positive into the specified terminal. Consult Unitorde Integrated Circuits databook for information regarding thermal specifications and limitations of packages.

Note 2: In normal operation VCC is powered through a current limiting resistor. Absolute maximum of 12V applies when VCC is driven from a low impedance source such that I_{CC} does not exceed 30mA.

	TEMPERATURE RANGE	PACKAGES
UCC2813	-40°C TO +85°C	N, D, PW
UCC3813	0°C TO +70°C	N, D, PW

ORDERING INFORMATION

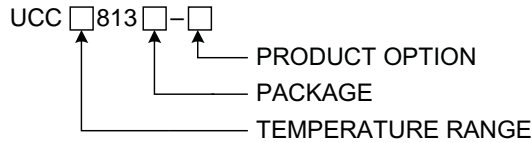

CONNECTION DIAGRAMS

DIL-8 or SOIC-8 (TOP VIEW) N or D PACKAGE

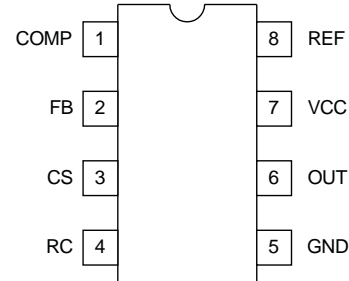

TSSOP-8 (TOP VIEW) PW PACKAGE

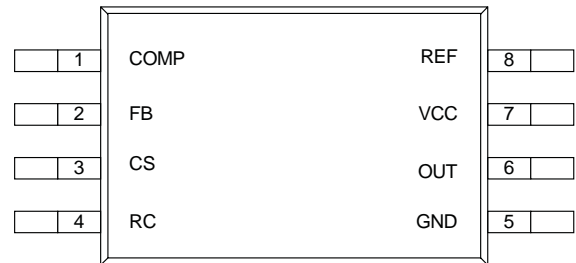

ELECTRICAL CHARACTERISTICS Unless otherwise stated, these specifications apply for -40°C ≤ T_A ≤ +85°C for UCC2813-x; 0°C ≤ T_A ≤ +70°C for UCC3813-x; VCC = 10V (Note 3); RT = 100k from REF to RC; CT=330pF from RC to GND; 0.1μF capacitor from VCC to GND; 0.1μF capacitor from VREF to GND. T_A = T_J.

PARAMETER	TEST CONDITIONS	UCC2813-x UCC3813-x			UNITS
		MIN	TYP	MAX	
Reference Section					
Output Voltage	T _J = +25°C, I = 0.2mA, UCCx813-0/-1/-2/-4	4.925	5.00	5.075	V
	T _J = +25°C, I = 0.2mA, UCCx813-5	3.94	4.00	4.06	V
Load Regulation	0.2mA < I < 5mA		10	30	mV
Total Variation	UCCx813 -0-1/-2/-4 (Note 7)	4.84	5.00	5.10	V
	UCCx813-5 (Note 7)	3.84	4.00	4.08	V
Output Noise Voltage	10Hz ≤ f ≤ 10kHz, T _J = +25°C (Note 9)		70		μV
Long Term Stability	T _A = +125 C, 1000 Hours (Note 9)		5		mV
Output Short Circuit		-5		-35	mA
Oscillator Section					
Oscillator Frequency	UCCx813-0/-1/-2/-4 (Note 4)	40	46	52	kHz
	UCCx813-5 (Note 4)	26	31	36	kHz
Temperature Stability	(Note 9)		2.5		%
Amplitude Peak-to-Peak		2.25	2.40	2.55	V
Oscillator Peak Voltage			2.45		V

ELECTRICAL CHARACTERISTICS Unless otherwise stated, these specifications apply for $-40^{\circ}\text{C} \leq T_A \leq +85^{\circ}\text{C}$ for UCC2813-x; $0^{\circ}\text{C} \leq T_A \leq +70^{\circ}\text{C}$ for UCC3813-x; VCC = 10V (Note 3); RT = 100k from REF to RC; CT=330pF from RC to GND; 0.1 μ F capacitor from VCC to GND; 0.1 μ F capacitor from VREF to GND. $T_A = T_J$.

PARAMETER	TEST CONDITIONS	UCC2813-x UCC3813-x			UNITS
		MIN	TYP	MAX	
Error Amplifier Section					
Input Voltage	COMP = 2.5V; UCCx813-0/-1/-2/-4	2.42	2.50	2.56	V
	COMP = 2.0V; UCCx813-3/-5	1.92	2.0	2.05	V
Input Bias Current		-2		2	μ A
Open Loop Voltage Gain		60	80		dB
COMP Sink Current	FB = 2.7V, COMP = 1.1V	0.4		2.5	mA
COMP Source Current	FB = 1.8V, COMP = REF - 1.2V	-0.2	-0.5	-0.8	mA
Gain Bandwidth Product	(Note 9)		2		MHz
PWM Section					
Maximum Duty Cycle	UCCx813-0/-2/-3	97	99	100	%
	UCCx813-1/-4/-5	48	49	50	
Minimum Duty Cycle	COMP = 0V			0	%
Current Sense Section					
Gain	(Note 5)	1.10	1.65	1.80	V/V
Maximum Input Signal	COMP = 5V (Note 6)	0.9	1.0	1.1	V
Input Bias Current		-200		200	nA
CS Blank Time		50	100	150	ns
Over-Current Threshold		1.32	1.55	1.70	V
COMP to CS Offset	CS = 0V	0.45	0.90	1.35	V
Output Section					
OUT Low Level	I = 20mA, all parts		0.1	0.4	V
	I = 200mA, all parts		0.35	0.90	V
	I = 50mA, VCC = 5V, UCCx813-3/-5		0.15	0.40	V
	I = 20mA, VCC = 0V, all parts		0.7	1.2	V
OUT High V _{SAT} (V _{CC} -OUT)	I = -20mA, all parts		0.15	0.40	V
	I = -200mA, all parts		1.0	1.9	V
	I = -50mA, VCC = 5V, UCCx813-3/-5		0.4	0.9	V
Rise Time	C _L = 1nF		41	70	ns
Fall Time	C _L = 1nF		44	75	ns
Undervoltage Lockout Section					
Start Threshold (Note 8)	UCCx813-0	6.6	7.2	7.8	V
	UCCx813-1	8.6	9.4	10.2	V
	UCCx813-2/-4	11.5	12.5	13.5	V
	UCCx813-3/-5	3.7	4.1	4.5	V
Stop Threshold (Note 8)	UCC1813-0	6.3	6.9	7.5	V
	UCC1813-1	6.8	7.4	8.0	V
	UCCx813-2/-4	7.6	8.3	9.0	V
	UCCx813-3/-5	3.2	3.6	4.0	V
Start to Stop Hysteresis	UCCx813-0	0.12	0.3	0.48	V
	UCCx813-1	1.6	2	2.4	V
	UCCx813-2/-4	3.5	4.2	5.1	V
	UCCx813-3/-5	0.2	0.5	0.8	V

ELECTRICAL CHARACTERISTICS Unless otherwise stated, these specifications apply for $-40^{\circ}\text{C} \leq T_A \leq +85^{\circ}\text{C}$ for UCC2813-x; $0^{\circ}\text{C} \leq T_A \leq +70^{\circ}\text{C}$ for UCC3813-x; VCC = 10V (Note 3); RT = 100k from REF to RC; CT=330pF from RC to GND; 0.1μF capacitor from VCC to GND; 0.1μF capacitor from VREF to GND. $T_A = T_J$.

PARAMETER	TEST CONDITIONS	UCC2813-x UCC3813-x			UNITS
		MIN	TYP	MAX	
Soft Start Section					
COMP Rise Time	FB = 1.8V, Rise from 0.5V to REF-1V		4		ms
Overall Section					
Start-up Current	VCC < Start Threshold		0.1	0.23	mA
Operating Supply Current	FB = 0V, CS = 0V, RC = 0V		0.5	1.2	mA
VCC Internal Zener Voltage	ICC = 10mA (Note 8)	12	13.5	15	V
VCC Internal Zener Voltage Minus Start Threshold Voltage	UCCx813-2/-4	0.5	1.0		V

Note 3: Adjust VCC above the start threshold before setting at 10V.

Note 4: Oscillator frequency for the UCCx813-0, UCCx813-2 and UCCx813-3 is the output frequency.

Oscillator frequency for the UCCx813-1, UCCx813-4 and UCCx813-5 is twice the output frequency.

Note 5: Gain is defined by: $A = \frac{V_{COMP}}{V_{CS}} \quad 0 \leq V_{CS} \leq 0.8V$.

Note 6: Parameter measured at trip point of latch with Pin 2 at 0V.

Note 7: Total Variation includes temperature stability and load regulation.

Note 8: Start Threshold, Stop Threshold and Zener Shunt Thresholds track one another.

Note 9: Guaranteed by design. Not 100% tested in production.

PIN DESCRIPTIONS

COMP: COMP is the output of the error amplifier and the input of the PWM comparator.

Unlike other devices, the error amplifier in the UCC3813 family is a true, low output-impedance, 2MHz operational amplifier. As such, the COMP terminal can both source and sink current. However, the error amplifier is internally current limited, so that you can command zero duty cycle by externally forcing COMP to GND.

The UCC3813 family features built-in full cycle Soft Start. Soft Start is implemented as a clamp on the maximum COMP voltage.

FB: FB is the inverting input of the error amplifier. For best stability, keep FB lead length as short as possible and FB stray capacitance as small as possible.

CS: CS is the input to the current sense comparators. The UCC3813 family has two different current sense comparators: the PWM comparator and an over-current comparator.

The UCC3813 family contains digital current sense filtering, which disconnects the CS terminal from the current

sense comparator during the 100ns interval immediately following the rising edge of the OUT pin. This digital filtering, also called leading-edge blanking, means that in most applications, no analog filtering (RC filter) is required on CS. Compared to an external RC filter technique, the leading-edge blanking provides a smaller effective CS to OUT propagation delay. Note, however, that the minimum non-zero On-Time of the OUT signal is directly affected by the leading-edge-blanking and the CS to OUT propagation delay.

The over-current comparator is only intended for fault sensing, and exceeding the over-current threshold will cause a soft start cycle.

RC: RC is the oscillator timing pin. For fixed frequency operation, set timing capacitor charging current by connecting a resistor from REF to RC. Set frequency by connecting a timing capacitor from RC to GND. For best performance, keep the timing capacitor lead to GND as short and direct as possible. If possible, use separate ground traces for the timing capacitor and all other functions.

PIN DESCRIPTIONS (cont.)

The frequency of oscillation can be estimated with the following equations:

$$\text{UCCx813-0/-1/-2/-4: } F = \frac{1.5}{R \cdot C}$$

$$\text{UCCx813-3, UCCx813-5: } F = \frac{1.0}{R \cdot C}$$

where frequency is in Hz, resistance is in Ω , and capacitance is in farads. The recommended range of timing resistors is between 10k and 200k and timing capacitor is 100pF to 1000pF. Never use a timing resistor less than 10k.

GND: GND is reference ground and power ground for all functions on this part.

OUT: OUT is the output of a high-current power driver capable of driving the gate of a power MOSFET with peak currents exceeding $\pm 750\text{mA}$. OUT is actively held low when VCC is below the UVLO threshold.

The high-current power driver consists of FET output devices, which can switch all of the way to GND and all of the way to VCC. The output stage also provides a very low impedance to overshoot and undershoot. This means that in many cases, external schottky clamp diodes are not required.

VCC: VCC is the power input connection for this device. In normal operation VCC is powered through a current limiting resistor. Although quiescent VCC current is very

low, total supply current will be higher, depending on OUT current. Total VCC current is the sum of quiescent VCC current and the average OUT current. Knowing the operating frequency and the MOSFET gate charge (Qg), average OUT current can be calculated from:

$$I_{OUT} = Q_g \cdot F.$$

To prevent noise problems, bypass VCC to GND with a ceramic capacitor as close to the VCC pin as possible. An electrolytic capacitor may also be used in addition to the ceramic capacitor.

REF: REF is the voltage reference for the error amplifier and also for many other functions on the IC. REF is also used as the logic power supply for high speed switching logic on the IC.

When VCC is greater than 1V and less than the UVLO threshold, REF is pulled to ground through a 5k Ω resistor. This means that REF can be used as a logic output indicating power system status. It is important for reference stability that REF is bypassed to GND with a ceramic capacitor as close to the pin as possible. An electrolytic capacitor may also be used in addition to the ceramic capacitor. A minimum of 0.1 μF ceramic is required. Additional REF bypassing is required for external loads greater than 2.5mA on the reference.

To prevent noise problems with high speed switching transients, bypass REF to ground with a ceramic capacitor very close to the IC package.

APPLICATION INFORMATION

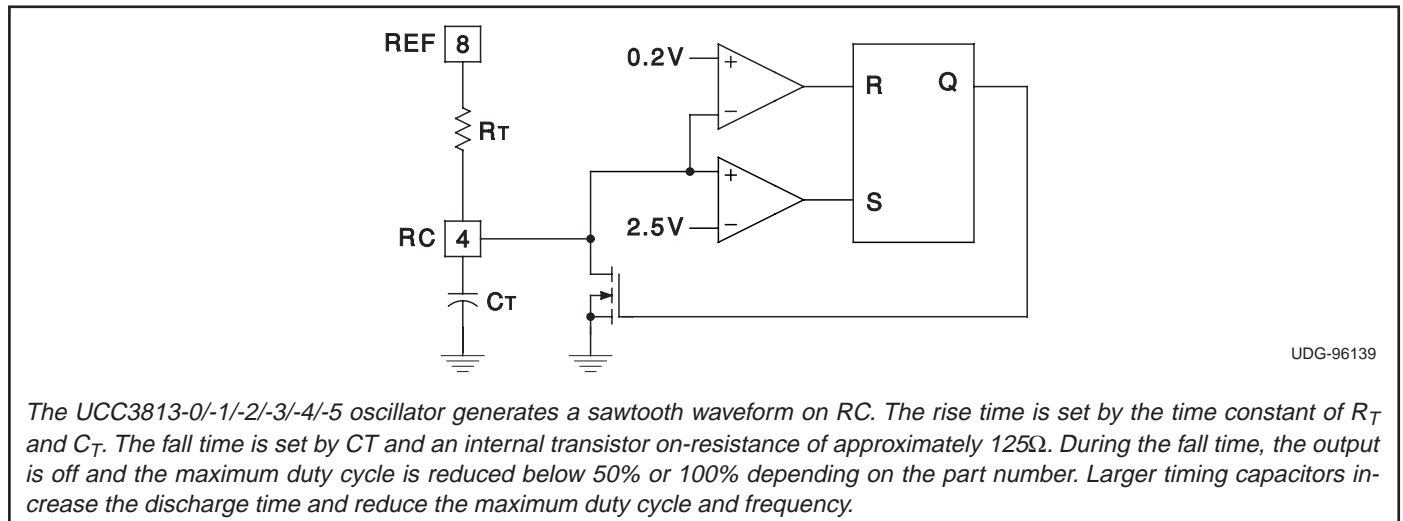

UDG-96139

The UCC3813-0/-1/-2/-3/-4/-5 oscillator generates a sawtooth waveform on RC. The rise time is set by the time constant of R_T and C_T . The fall time is set by C_T and an internal transistor on-resistance of approximately 125 Ω . During the fall time, the output is off and the maximum duty cycle is reduced below 50% or 100% depending on the part number. Larger timing capacitors increase the discharge time and reduce the maximum duty cycle and frequency.

Figure 1. Oscillator.

APPLICATION INFORMATION (cont.)

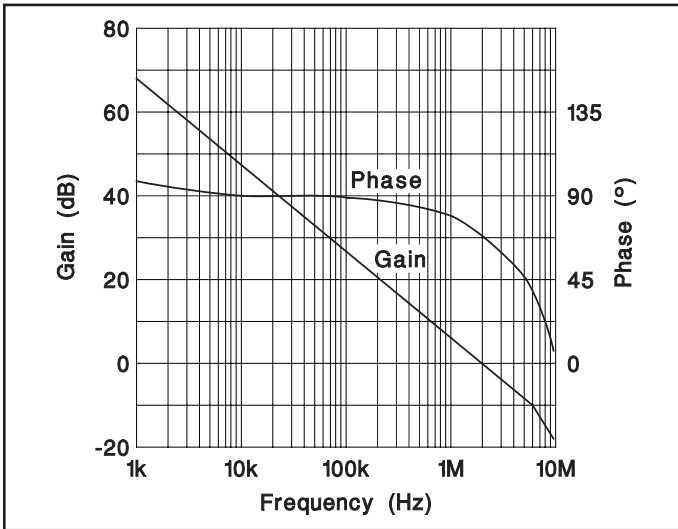

Figure 2. Error amplifier gain/phase response.

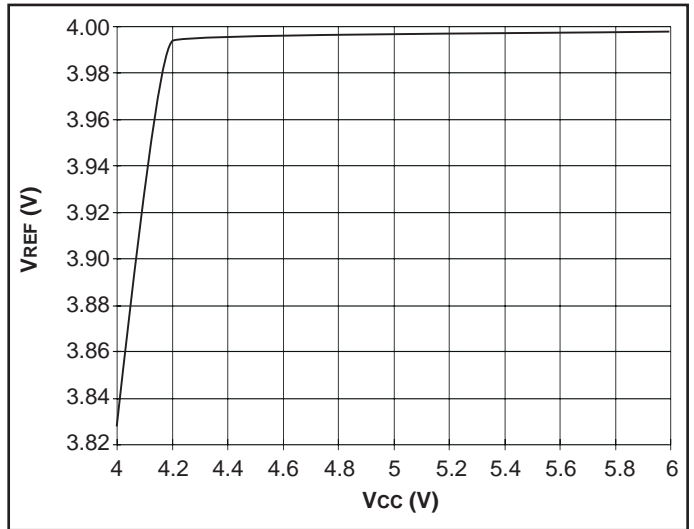

Figure 5. UCC3813-3/-5 V_{REF} vs. V_{CC} ; $I_{LOAD} = 0.5mA$.

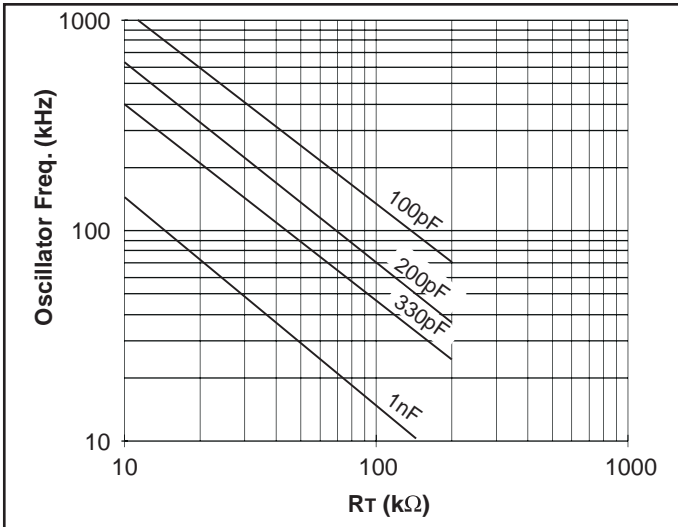

Figure 3. UCC3813-0/-1/-2/-4 oscillator frequency vs. R_T and C_T .

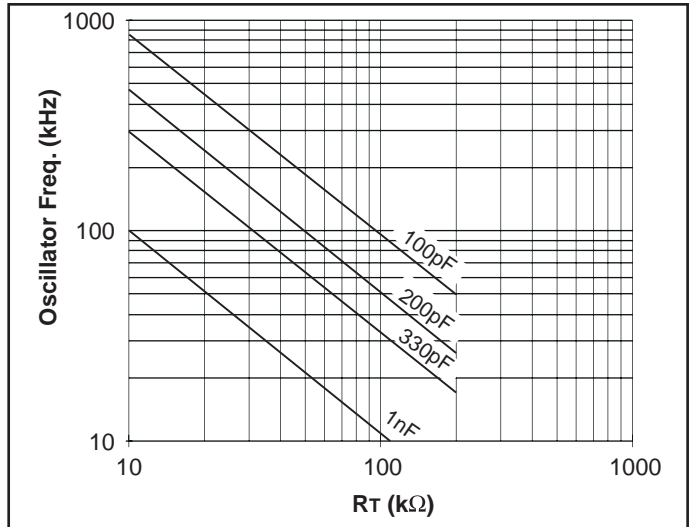

Figure 6. UCC3813-3/-5 oscillator frequency vs. R_T and C_T .

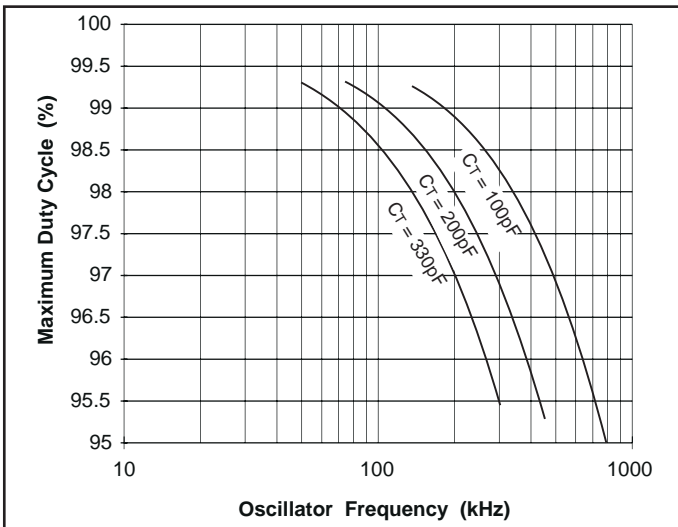

Figure 4. UCC3813-0/-2/-3 max. duty cycle vs. oscillator frequency.

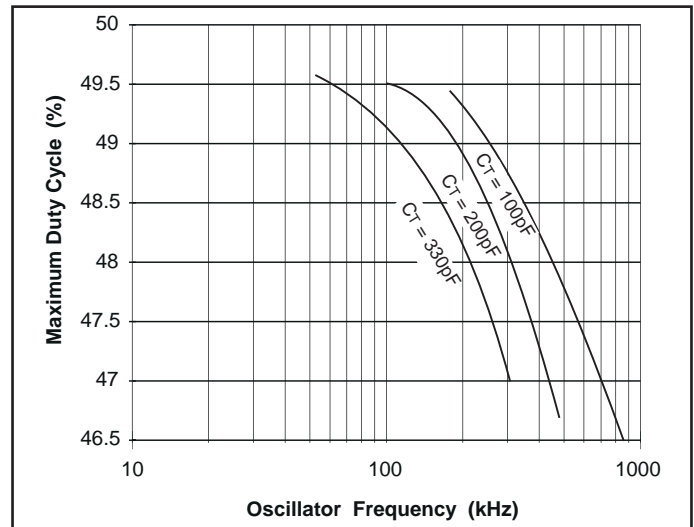

Figure 7. UCC3813-1/-4/-5 max. duty cycle vs. oscillator frequency.

APPLICATION INFORMATION (cont.)

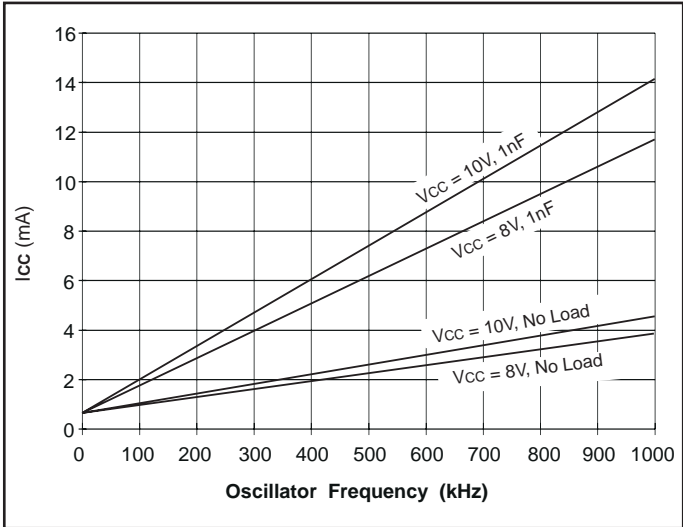

Figure 8. UCC3813-0 I_{CC} vs. oscillator frequency.

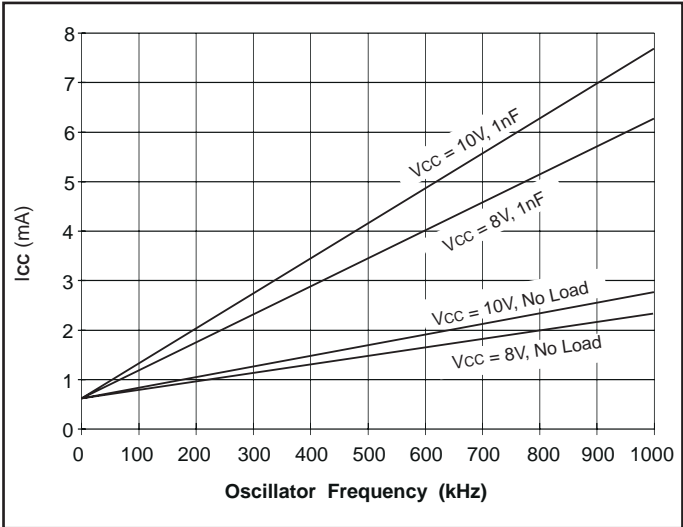

Figure 10. UCC3813-5 I_{CC} vs. oscillator frequency.

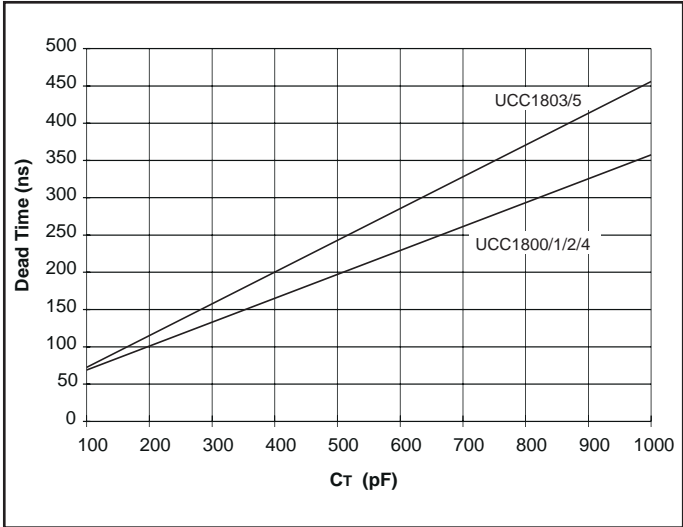

Figure 9. Dead time vs. C_T , $R_T = 100k$.

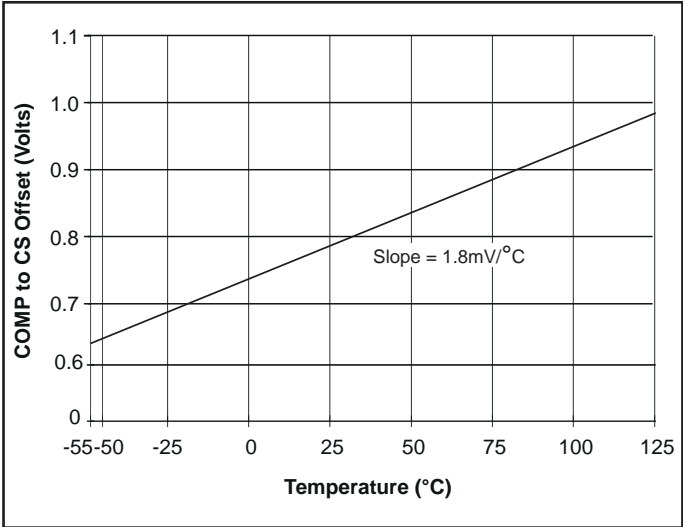

Figure 11. COMP to CS offset vs. temperature, $CS = 0V$.

IMPORTANT NOTICE

Texas Instruments and its subsidiaries (TI) reserve the right to make changes to their products or to discontinue any product or service without notice, and advise customers to obtain the latest version of relevant information to verify, before placing orders, that information being relied on is current and complete. All products are sold subject to the terms and conditions of sale supplied at the time of order acknowledgement, including those pertaining to warranty, patent infringement, and limitation of liability.

TI warrants performance of its semiconductor products to the specifications applicable at the time of sale in accordance with TI's standard warranty. Testing and other quality control techniques are utilized to the extent TI deems necessary to support this warranty. Specific testing of all parameters of each device is not necessarily performed, except those mandated by government requirements.

CERTAIN APPLICATIONS USING SEMICONDUCTOR PRODUCTS MAY INVOLVE POTENTIAL RISKS OF DEATH, PERSONAL INJURY, OR SEVERE PROPERTY OR ENVIRONMENTAL DAMAGE ("CRITICAL APPLICATIONS"). TI SEMICONDUCTOR PRODUCTS ARE NOT DESIGNED, AUTHORIZED, OR WARRANTED TO BE SUITABLE FOR USE IN LIFE-SUPPORT DEVICES OR SYSTEMS OR OTHER CRITICAL APPLICATIONS. INCLUSION OF TI PRODUCTS IN SUCH APPLICATIONS IS UNDERSTOOD TO BE FULLY AT THE CUSTOMER'S RISK.

In order to minimize risks associated with the customer's applications, adequate design and operating safeguards must be provided by the customer to minimize inherent or procedural hazards.

TI assumes no liability for applications assistance or customer product design. TI does not warrant or represent that any license, either express or implied, is granted under any patent right, copyright, mask work right, or other intellectual property right of TI covering or relating to any combination, machine, or process in which such semiconductor products or services might be or are used. TI's publication of information regarding any third party's products or services does not constitute TI's approval, warranty or endorsement thereof.